

Ultra Field Stop IGBT, 1200 V, 75 A

FGY75T120SQDN

General Description

This Insulated Gate Bipolar Transistor (IGBT) features a robust and cost effective Ultra Field Stop Trench construction, and provides superior performance in demanding switching applications, offering both low on-state voltage and minimal switching loss. The IGBT is well suited for UPS and solar applications. Incorporated into the device is a soft and fast co-packaged free wheeling diode with a low forward voltage.

Features

- Extremely Efficient Trench with Field Stop Technology
- Maximum Junction Temperature: $T_J = 175^\circ\text{C}$
- Low Saturation Voltage: $V_{CE(sat)} = 1.7\text{ V (Typ.) @ } I_C = 75\text{ A}$
- 100% of the Parts Tested for $I_{LM}(1)$
- Soft Fast Reverse Recovery Diode
- Optimized for High Speed Switching
- RoHS Compliant

Applications

- Solar Inverter, UPS

ABSOLUTE MAXIMUM RATINGS

($T_J = 25^\circ\text{C}$ unless otherwise stated)

Symbol	Parameter	Value	Unit
V_{CES}	Collector to Emitter Voltage	1200	V
V_{GES}	Gate to Emitter Voltage	± 20	V
	Transient Gate to Emitter Voltage	± 30	V
I_C	Collector Current @ $T_C = 25^\circ\text{C}$	150	A
	Collector Current @ $T_C = 100^\circ\text{C}$	75	A
$I_{LM}(1)$	Pulsed Collector Current @ $T_C = 25^\circ\text{C}$	300	A
$I_{CM}(2)$	Pulsed Collector Current	300	A
I_F	Diode Forward Current @ $T_C = 25^\circ\text{C}$	150	A
	Diode Forward Current @ $T_C = 100^\circ\text{C}$	75	A
I_{FM}	Pulsed Diode Max. Forward Current	300	A
P_D	Maximum Power Dissipation @ $T_C = 25^\circ\text{C}$ @ $T_C = 100^\circ\text{C}$	790	W
		395	
T_J	Operating Junction Temperature	-55 to +175	$^\circ\text{C}$
T_{stg}	Storage Temperature Range	-55 to +175	$^\circ\text{C}$
T_L	Maximum Lead Temp. for soldering Purposes, 1/8" from case for 5 s	300	$^\circ\text{C}$

Stresses exceeding those listed in the Maximum Ratings table may damage the device. If any of these limits are exceeded, device functionality should not be assumed, damage may occur and reliability may be affected.

1. $V_{CC} = 800\text{ V}$, $V_{GE} = 15\text{ V}$, $I_C = 300\text{ A}$, $R_G = 68\ \Omega$, Inductive Load.
2. Repetitive rating: Pulse width limited by max. junction temperature.

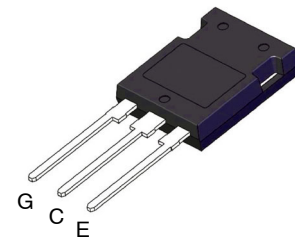
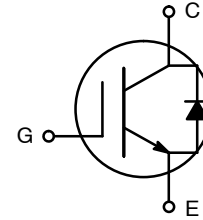

TO-247-3LD
CASE 340CD

MARKING DIAGRAM

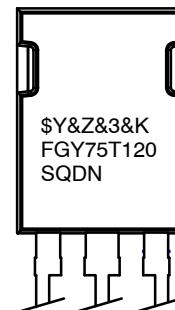

&Y = onsemi Logo
 &Z = Assembly Plant Code
 &3 = Date Code (Year & Week)
 &K = Lot Run Traceability Code
 FGY75T120SQDN = Specific Device Code

ORDERING INFORMATION

See detailed ordering and shipping information on page 3 of this data sheet.

FGY75T120SQDN

THERMAL CHARACTERISTICS

Symbol	Parameter	Value	Unit
$R_{\theta JC}$ (IGBT)	Thermal Resistance, Junction to Case, Max.	0.19	°C/W
$R_{\theta JC}$ (Diode)	Thermal Resistance, Junction to Case, Max.	0.38	°C/W
$R_{\theta JA}$	Thermal Resistance, Junction to Ambient, Max.	40	°C/W

ELECTRICAL CHARACTERISTICS OF THE IGBT ($T_C = 25^\circ\text{C}$ unless otherwise noted)

Symbol	Parameter	Test Conditions	Min	Typ	Max	Unit
--------	-----------	-----------------	-----	-----	-----	------

OFF CHARACTERISTICS

BV_{CES}	Collector to Emitter Breakdown Voltage	$V_{GE} = 0\text{ V}, I_C = 500\ \mu\text{A}$	1200	-	-	V
I_{CES}	Collector Cut-Off Current	$V_{CE} = V_{CES}, V_{GE} = 0\text{ V}$	-	-	400	μA
I_{GES}	G-E Leakage Current	$V_{GE} = V_{GES}, V_{CE} = 0\text{ V}$	-	-	± 200	nA

ON CHARACTERISTICS

$V_{GE(th)}$	G-E Threshold Voltage	$I_C = 400\ \mu\text{A}, V_{CE} = V_{GE}$	4.5	5.5	6.5	V
$V_{CE(sat)}$	Collector to Emitter Saturation Voltage	$I_C = 75\ \text{A}, V_{GE} = 15\ \text{V}$	-	1.7	1.95	V
		$I_C = 75\ \text{A}, V_{GE} = 15\ \text{V}, T_C = 175^\circ\text{C}$	-	2.3	-	V

DYNAMIC CHARACTERISTICS

C_{ies}	Input Capacitance	$V_{CE} = 20\ \text{V}, V_{GE} = 0\ \text{V}, f = 1\ \text{MHz}$	-	9060	-	pF
C_{oes}	Output Capacitance		-	242	-	pF
C_{res}	Reverse Transfer Capacitance		-	137	-	pF

SWITCHING CHARACTERISTICS

$t_{d(on)}$	Turn-On Delay Time	$V_{CC} = 600\ \text{V}, I_C = 75\ \text{A}, R_G = 10\ \Omega, V_{GE} = 15\ \text{V},$ Inductive Load, $T_C = 25^\circ\text{C}$	-	64	-	ns
t_r	Rise Time		-	96	-	ns
$t_{d(off)}$	Turn-Off Delay Time		-	332	-	ns
t_f	Fall Time		-	28	-	ns
E_{on}	Turn-On Switching Loss		-	6.25	-	mJ
E_{off}	Turn-Off Switching Loss		-	1.96	-	mJ
E_{ts}	Total Switching Loss		-	8.21	-	mJ
$t_{d(on)}$	Turn-On Delay Time	$V_{CC} = 600\ \text{V}, I_C = 75\ \text{A}, R_G = 10\ \Omega, V_{GE} = 15\ \text{V},$ Inductive Load, $T_C = 175^\circ\text{C}$	-	56	-	ns
t_r	Rise Time		-	80	-	ns
$t_{d(off)}$	Turn-Off Delay Time		-	364	-	ns
t_f	Fall Time		-	88	-	ns
E_{on}	Turn-On Switching Loss		-	8.67	-	mJ
E_{off}	Turn-Off Switching Loss		-	3.2	-	mJ
E_{ts}	Total Switching Loss		-	11.87	-	mJ
Q_g	Total Gate Charge	$V_{CE} = 600\ \text{V}, I_C = 75\ \text{A}, V_{GE} = 15\ \text{V}$	-	399	-	nC
Q_{ge}	Gate to Emitter Charge		-	74	-	nC
Q_{gc}	Gate to Collector Charge		-	192	-	nC

Product parametric performance is indicated in the Electrical Characteristics for the listed test conditions, unless otherwise noted. Product performance may not be indicated by the Electrical Characteristics if operated under different conditions.

FGY75T120SQDN

ELECTRICAL CHARACTERISTICS OF THE DIODE ($T_C = 25^\circ\text{C}$ unless otherwise noted)

Symbol	Parameter	Test Conditions	Min	Typ	Max	Unit	
V_{FM}	Diode Forward Voltage	$I_F = 75\text{ A}$	$T_C = 25^\circ\text{C}$	-	3.4	4	V
			$T_C = 175^\circ\text{C}$	-	2.7	-	
t_{rr}	Diode Reverse Recovery Time	$V_R = 600\text{ V}, I_F = 75\text{ A}, dI_F/dt = 500\text{ A}/\mu\text{s}$	$T_C = 25^\circ\text{C}$	-	99	-	ns
			$T_C = 175^\circ\text{C}$	-	329	-	
Q_{rr}	Diode Reverse Recovery Charge		$T_C = 25^\circ\text{C}$	-	1001	-	nC
			$T_C = 175^\circ\text{C}$	-	5696	-	
I_{rrm}	Diode Reverse Recovery Current		$T_C = 25^\circ\text{C}$	-	20	-	A
			$T_C = 175^\circ\text{C}$	-	34	-	

Product parametric performance is indicated in the Electrical Characteristics for the listed test conditions, unless otherwise noted. Product performance may not be indicated by the Electrical Characteristics if operated under different conditions.

PACKAGE MARKING AND ORDERING INFORMATION

Part Number	Top Mark	Package	Shipping
FGY75T120SQDN	FGY75T120SQDN	TO-247-3LD (Pb-Free)	30 / Tube

FGY75T120SQDN

TYPICAL CHARACTERISTICS

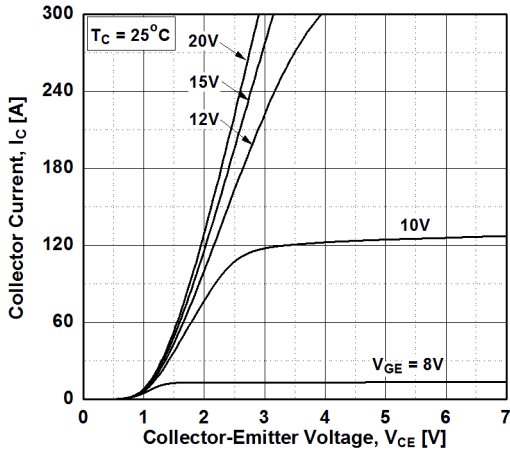

Figure 1. Typical Output Characteristics (25°C)

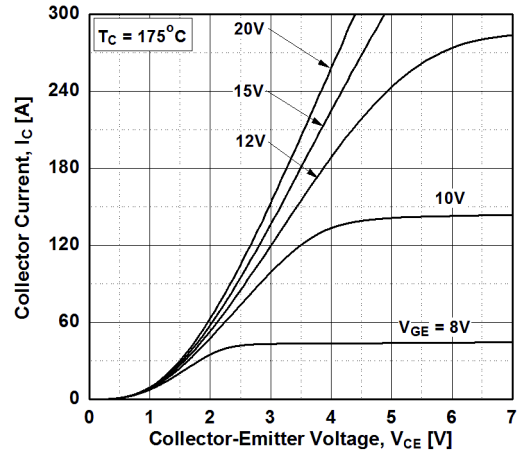

Figure 2. Typical Output Characteristics (175°C)

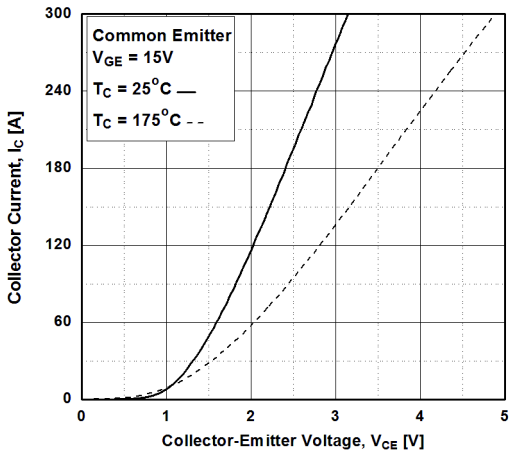

Figure 3. Typical Saturation Voltage Characteristics

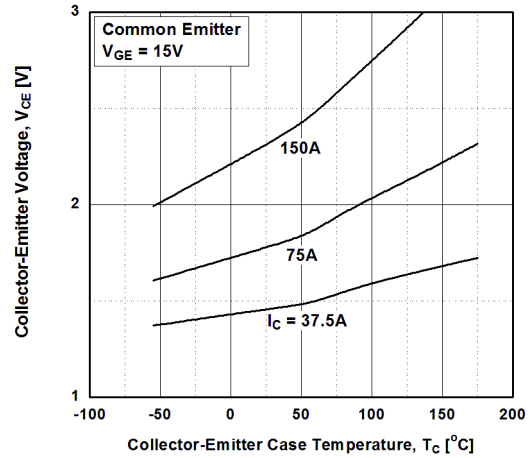

Figure 4. Saturation Voltage vs. Case Temperature at Variant Current Level

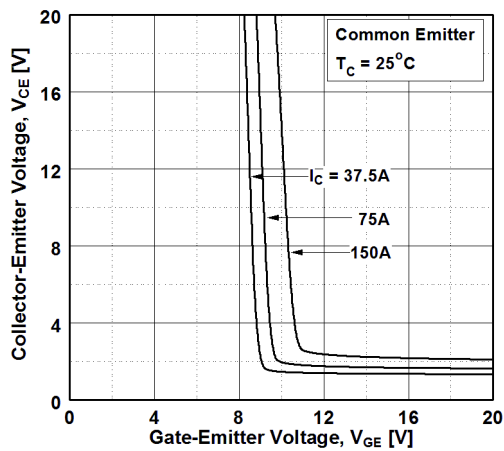

Figure 5. Saturation Voltage vs. V_{GE} (25°C)

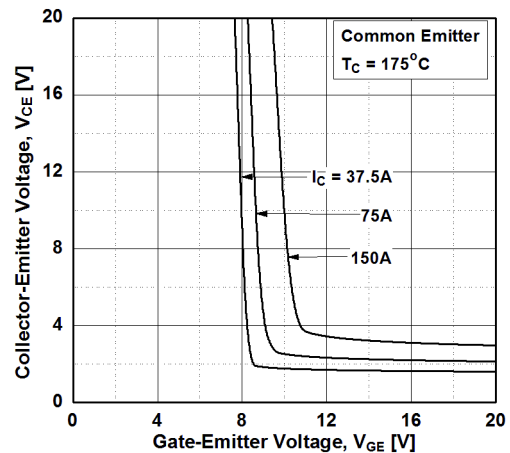

Figure 6. Saturation Voltage vs. V_{GE} (175°C)

FGY75T120SQDN

TYPICAL CHARACTERISTICS

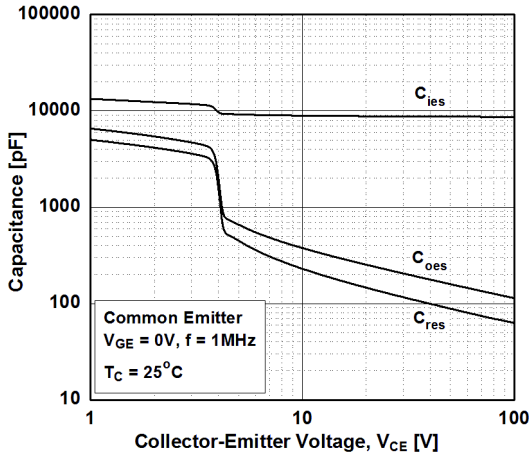

Figure 7. Capacitance Characteristics

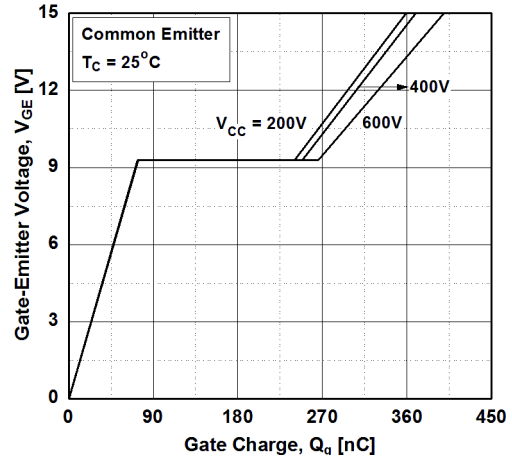

Figure 8. Gate Charge Characteristics

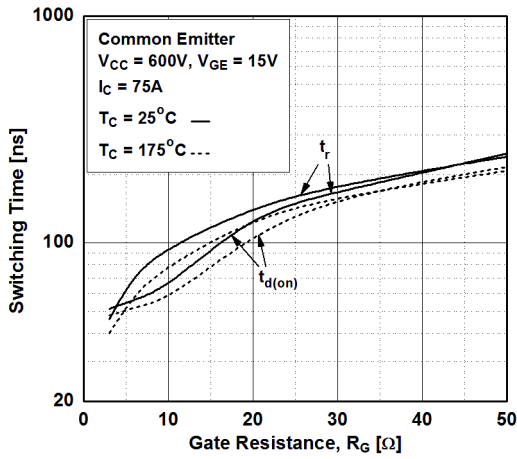

Figure 9. Turn-On Characteristics vs. Gate Resistance

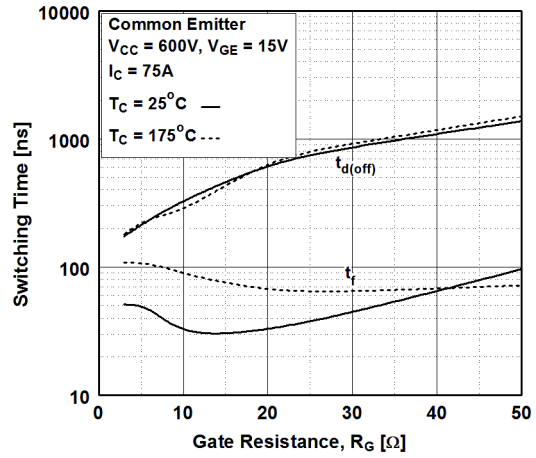

Figure 10. Turn-Off Characteristics vs. Gate Resistance

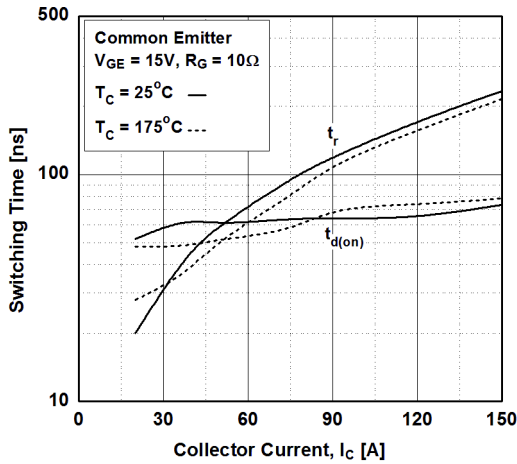

Figure 11. Turn-On Characteristics vs. Collector Current

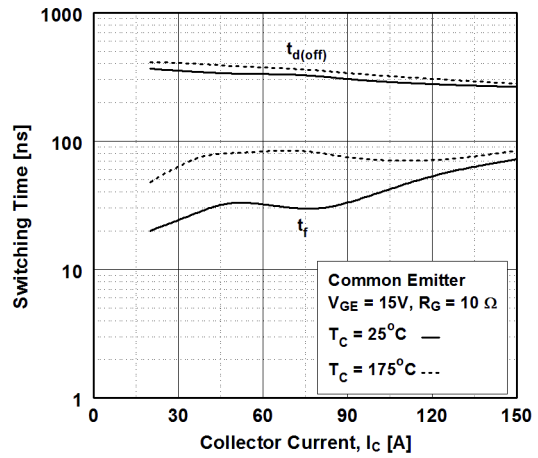

Figure 12. Turn-Off Characteristics vs. Collector Current

FGY75T120SQDN

TYPICAL CHARACTERISTICS

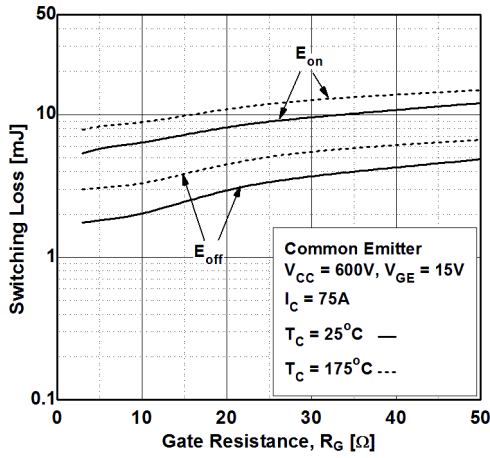

Figure 13. Switching Loss vs. Gate Resistance

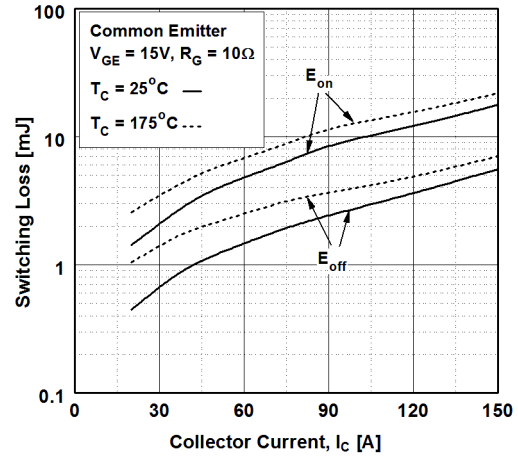

Figure 14. Switching Loss vs. Collector Current

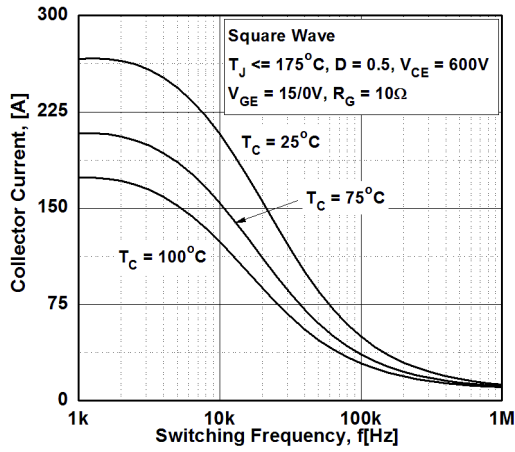

Figure 15. Load Current vs. Frequency

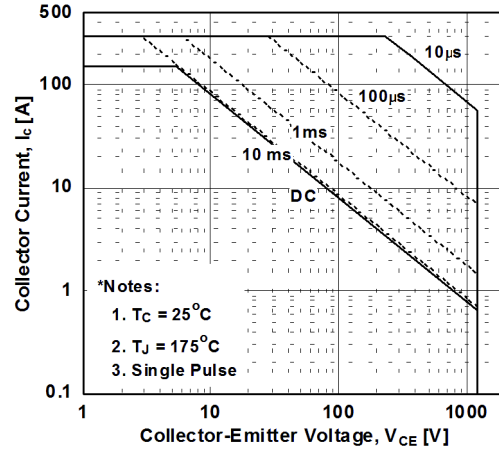

Figure 16. SOA Characteristics

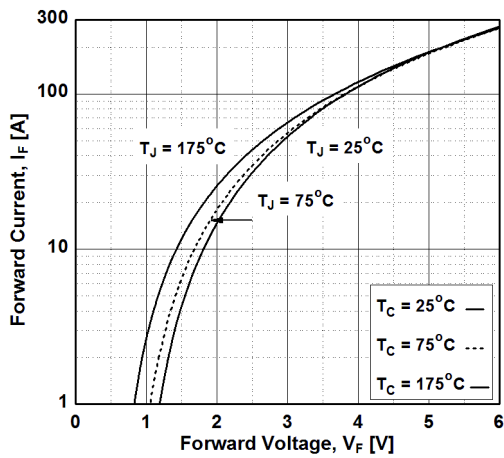

Figure 17. Forward Characteristics

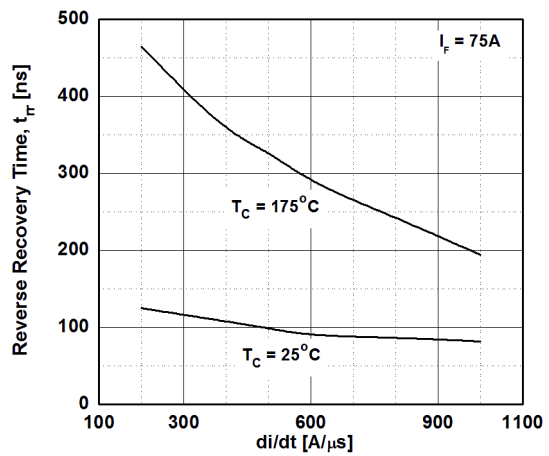

Figure 18. Reverse Recovery Time vs. di_F/dt

FGY75T120SQDN

TYPICAL CHARACTERISTICS

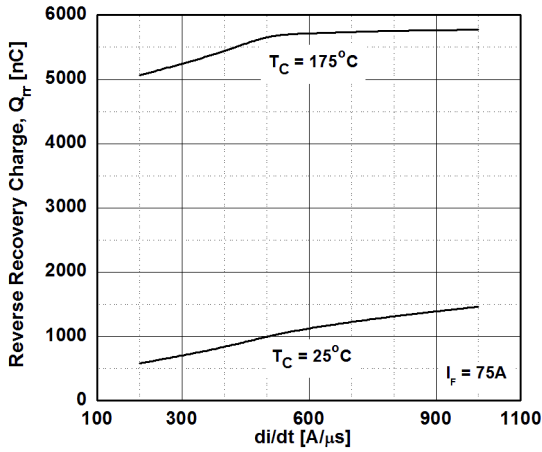

Figure 19. Reverse Recovery Charge vs. di_F/dt

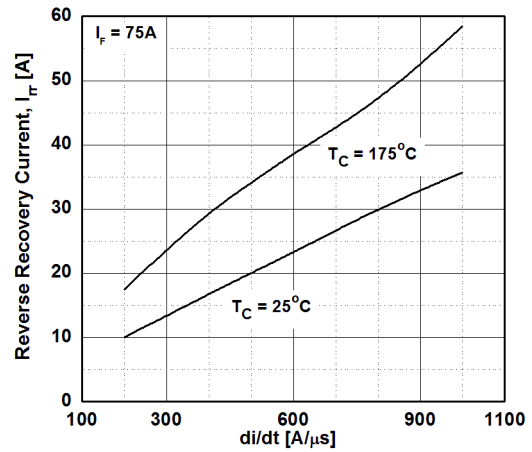

Figure 20. Reverse Recovery Current vs. di_F/dt

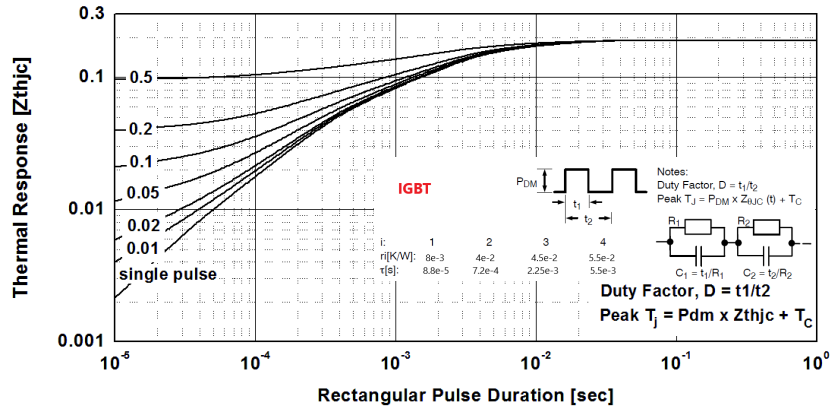

Figure 21. Transient Thermal Impedance of IGBT

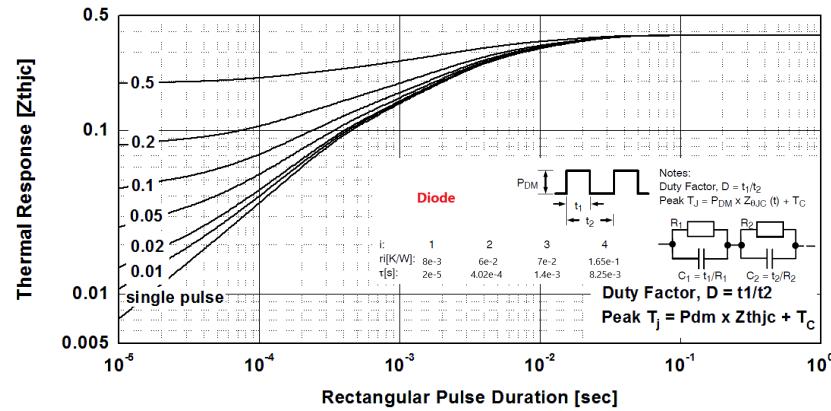
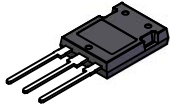

Figure 22. Transient Thermal Impedance of Diode

MECHANICAL CASE OUTLINE

PACKAGE DIMENSIONS



TO-247-3LD
CASE 340CD
ISSUE A

DATE 18 SEP 2018

NOTES:

- A. THIS PACKAGE DOES NOT CONFORM TO ANY STANDARDS.
- B. ALL DIMENSIONS ARE IN MILLIMETERS.
- C. DIMENSIONS ARE EXCLUSIVE OF BURRS, MOLD FLASH AND TIE BAR PROTRUSIONS.
- D. DIMENSION AND TOLERANCE AS PER ASME Y14.5-2009.

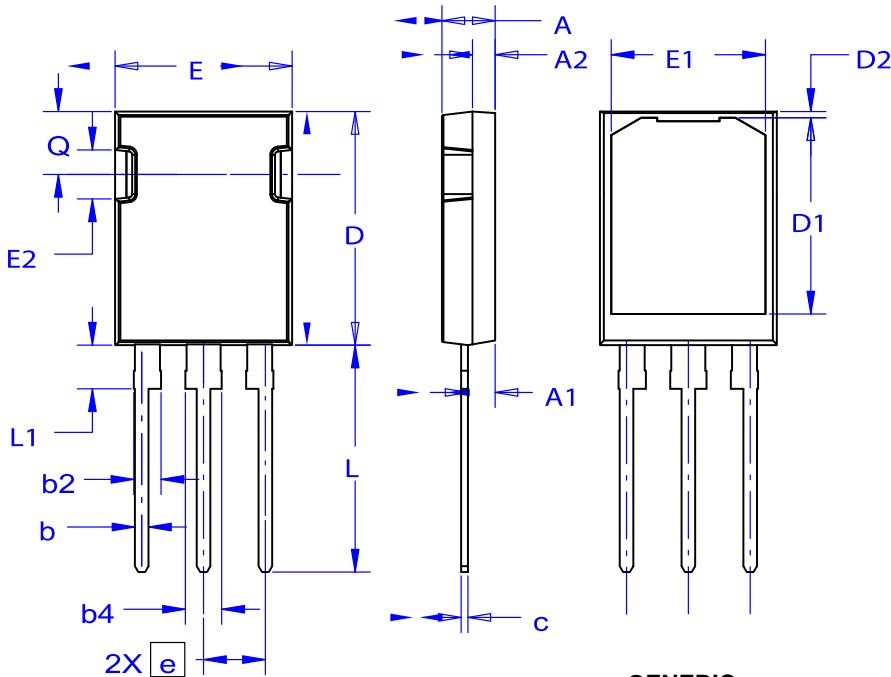

DIM	MILLIMETERS		
	MIN	NOM	MAX
A	4.58	4.70	4.82
A1	2.20	2.40	2.60
A2	1.80	2.00	2.20
D	20.32	20.57	20.82
E	15.37	15.62	15.87
E2	4.12	4.32	4.52
e	~	5.45	~
L	19.90	20.00	20.10
L1	3.69	3.81	3.93
Q	5.34	5.46	5.58
b	1.10	1.20	1.30
b2	2.10	2.24	2.39
b4	2.87	3.04	3.20
c	0.51	0.61	0.71
D1	16.63	16.83	17.03
D2	0.51	0.93	1.35
E1	13.40	13.60	13.80

GENERIC MARKING DIAGRAM*



- XXXX = Specific Device Code
- A = Assembly Location
- Y = Year
- WW = Work Week
- G = Pb-Free Package

*This information is generic. Please refer to device data sheet for actual part marking. Pb-Free indicator, "G" or microdot "•", may or may not be present. Some products may not follow the Generic Marking.

DOCUMENT NUMBER:	98AON13857G	Electronic versions are uncontrolled except when accessed directly from the Document Repository. Printed versions are uncontrolled except when stamped "CONTROLLED COPY" in red.
DESCRIPTION:	TO-247-3LD	PAGE 1 OF 1

ON Semiconductor and are trademarks of Semiconductor Components Industries, LLC dba ON Semiconductor or its subsidiaries in the United States and/or other countries. ON Semiconductor reserves the right to make changes without further notice to any products herein. ON Semiconductor makes no warranty, representation or guarantee regarding the suitability of its products for any particular purpose, nor does ON Semiconductor assume any liability arising out of the application or use of any product or circuit, and specifically disclaims any and all liability, including without limitation special, consequential or incidental damages. ON Semiconductor does not convey any license under its patent rights nor the rights of others.

onsemi, **Onsemi**, and other names, marks, and brands are registered and/or common law trademarks of Semiconductor Components Industries, LLC dba "**onsemi**" or its affiliates and/or subsidiaries in the United States and/or other countries. **onsemi** owns the rights to a number of patents, trademarks, copyrights, trade secrets, and other intellectual property. A listing of **onsemi**'s product/patent coverage may be accessed at www.onsemi.com/site/pdf/Patent-Marking.pdf. **onsemi** reserves the right to make changes at any time to any products or information herein, without notice. The information herein is provided "as-is" and **onsemi** makes no warranty, representation or guarantee regarding the accuracy of the information, product features, availability, functionality, or suitability of its products for any particular purpose, nor does **onsemi** assume any liability arising out of the application or use of any product or circuit, and specifically disclaims any and all liability, including without limitation special, consequential or incidental damages. Buyer is responsible for its products and applications using **onsemi** products, including compliance with all laws, regulations and safety requirements or standards, regardless of any support or applications information provided by **onsemi**. "Typical" parameters which may be provided in **onsemi** data sheets and/or specifications can and do vary in different applications and actual performance may vary over time. All operating parameters, including "Typicals" must be validated for each customer application by customer's technical experts. **onsemi** does not convey any license under any of its intellectual property rights nor the rights of others. **onsemi** products are not designed, intended, or authorized for use as a critical component in life support systems or any FDA Class 3 medical devices or medical devices with a same or similar classification in a foreign jurisdiction or any devices intended for implantation in the human body. Should Buyer purchase or use **onsemi** products for any such unintended or unauthorized application, Buyer shall indemnify and hold **onsemi** and its officers, employees, subsidiaries, affiliates, and distributors harmless against all claims, costs, damages, and expenses, and reasonable attorney fees arising out of, directly or indirectly, any claim of personal injury or death associated with such unintended or unauthorized use, even if such claim alleges that **onsemi** was negligent regarding the design or manufacture of the part. **onsemi** is an Equal Opportunity/Affirmative Action Employer. This literature is subject to all applicable copyright laws and is not for resale in any manner.

ADDITIONAL INFORMATION

TECHNICAL PUBLICATIONS:

Technical Library: www.onsemi.com/design/resources/technical-documentation
onsemi Website: www.onsemi.com

ONLINE SUPPORT: www.onsemi.com/support

For additional information, please contact your local Sales Representative at www.onsemi.com/support/sales