

FD-4030-12A-(C1~C4)-C**Features / Applications :**

- OverCurrent Protection: Protect batteries from abnormal overcurrent behavior.
- OverVoltage Protection: Protect batteries from abnormal overvoltage behavior.
- Surface mountable fuse
- Halogen free
- Fast response time
- UL certificated: E314624 / TUV file number: TA50201483

Electrical Specifications :

Characteristics	Feature
Rated Voltage(*1)	35VDC
Rated Breaking Capacity	50A
Re-flow Temp.(MAX)	260°C
Fuse Resistance(Typical)	2~4mΩ
Heater Resistance	C1: 0.63~1.35Ω
	C2: 2.00~2.65Ω
	C3: 5.00~9.00Ω
	C4: 9.80~18.0Ω
Operating Voltage	C1: 3.00~4.50V
	C2: 4.00~9.00V
	C3: 7.40~14.0V
	C4: 10.5~19.6V

Note:

Maximum voltage is not the operating voltage for the heater.

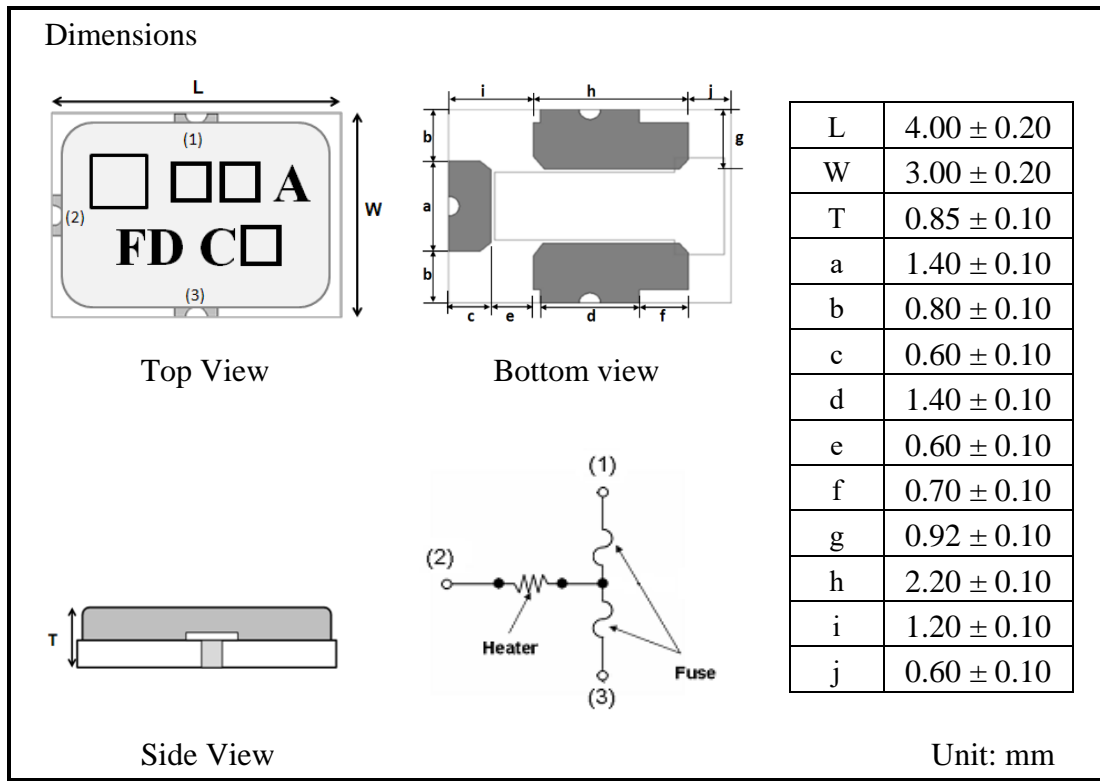
Outline Drawing :

Type Designation :

FD - 4030 - 12A - C□ - C
 (1) (2) (3) (4) (5)

Note:

- (1) FD : Series number
- (2) 4030 : 4.0 mm * 3.0 mm size
- (3) 12A : Rated current
- (4) C□ : Cells
 C1 : One cell
 C2 : Two cell
 C3 : Three cell
 C4 : Four cell
- (5) C : C version

Characteristics :

Electric performance

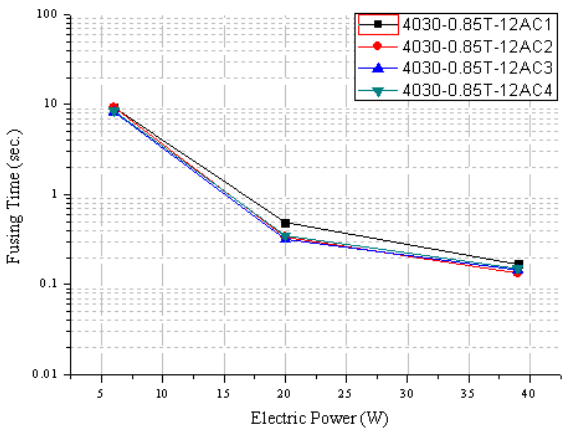
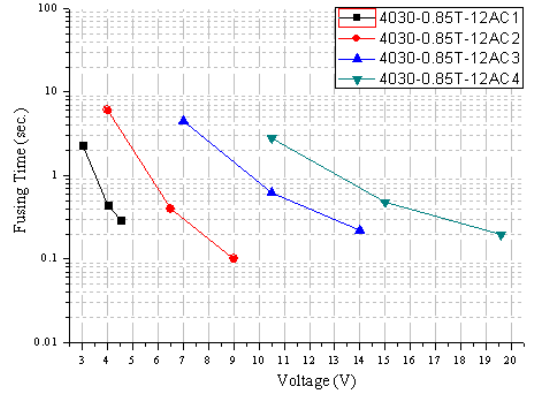
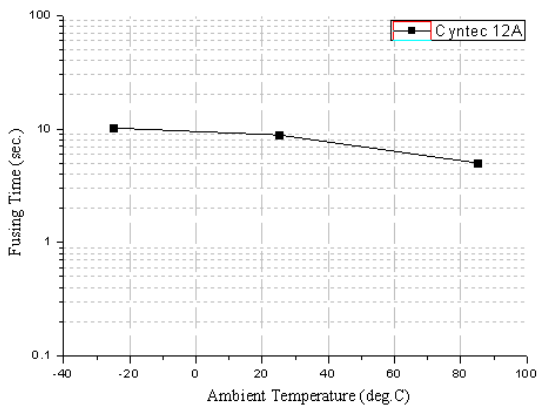
Item	Specification and Requirement
Fusing Time vs Electric Power	
Fusing Time vs Voltage	 <p style="text-align: center;"> ※ 12AC1 Heater resistance is about 1.00 Ω ※ 12AC2 Heater resistance is about 2.30 Ω ※ 12AC3 Heater resistance is about 7.00 Ω ※ 12AC4 Heater resistance is about 13.9 Ω </p>
Fusing Time by Heater vs Ambient Temperature	 <p style="text-align: center;"> ※ Testing Power: 6W </p>

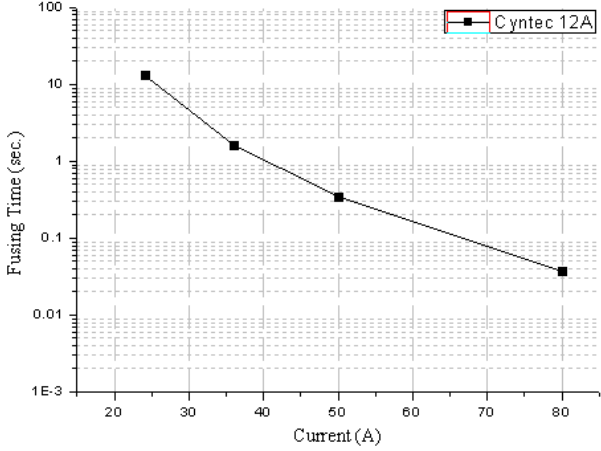
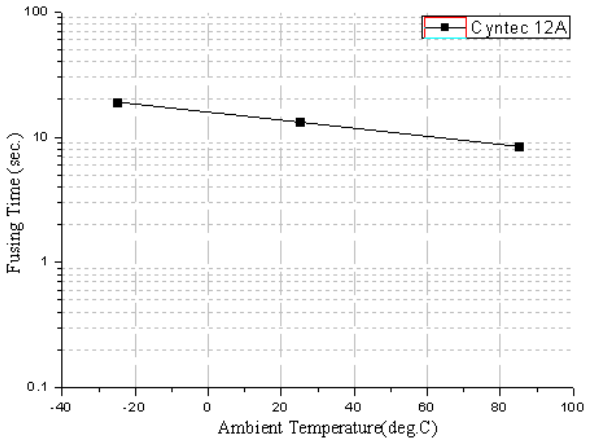
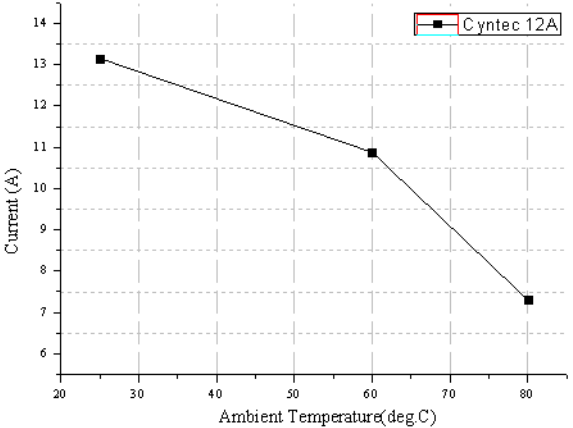
<p>Fusing Time vs Current</p>	 <p>※ 12A Fuse resistance is about 3.0 mΩ</p>
<p>Fusing Time by Current vs Ambient Temperature</p>	 <p>※ 12A Fuse resistance is about 3.0 mΩ (Fusing Current = 24A)</p>
<p>Current Carrying Capacity</p>	 <p>※ Measure the current to reach the surface temperature which is 100°C with different ambient temperature. ※ Fuse resistance is about 3.0 mΩ</p>

Reliability

Test Item	Condition of Test	Requirements
Carrying capacity (UL248-14)	100% of rated current, 4hr	Without melting
Temperature Rise (UL248-14)	100% of rated current, measure of surface temperature.	$\Delta T < 75^{\circ}\text{C}$
Fusing time (UL248-14)	200% rated current; C1、C3、C4 : 6W~39W shall be applied to heater. C2 : 6W~40W shall be applied to heater.	Clearing time < 1 min
Interrupting Ability	After the fuse is interrupted, rated voltage applied for 30sec again.	No mechanical damages
Residual Resistance (UL248-14)	Measure DC resistance after fusing.	> 10k Ω
Solderability (JEDEC J-STD-020D)	Temperature of Solder: $245 \pm 5^{\circ}\text{C}$ Immersion Duration: 3 ± 0.5 second Refer to JIS C 5201-1 4.17	Uniform coating of solder cover minimum of 95% surface being immersed
High Temperature Exposure (JESD22-A103C)	Kept at 100°C for 1,000 hours.	$\Delta R: \pm 10\%$ Without distinct damage in appearance
Thermal Shock (JESD22-A104C)	$-55^{\circ}\text{C}/25^{\circ}\text{C}/125^{\circ}\text{C}/25^{\circ}\text{C}$, 100 cycles.	$\Delta R < 10\%$ Without distinct damage in appearance
Current Rush Withstand	80A-10ms-On, 9990ms-Off, 500cycle.	No fusing

Recommended Solder Pad Dimensions:

The printed circuit board thickness is 0.6mm.

The thickness of tin plated copper layers is 2oz.

Recommended thickness of solder printing board is 0.12mm at least.

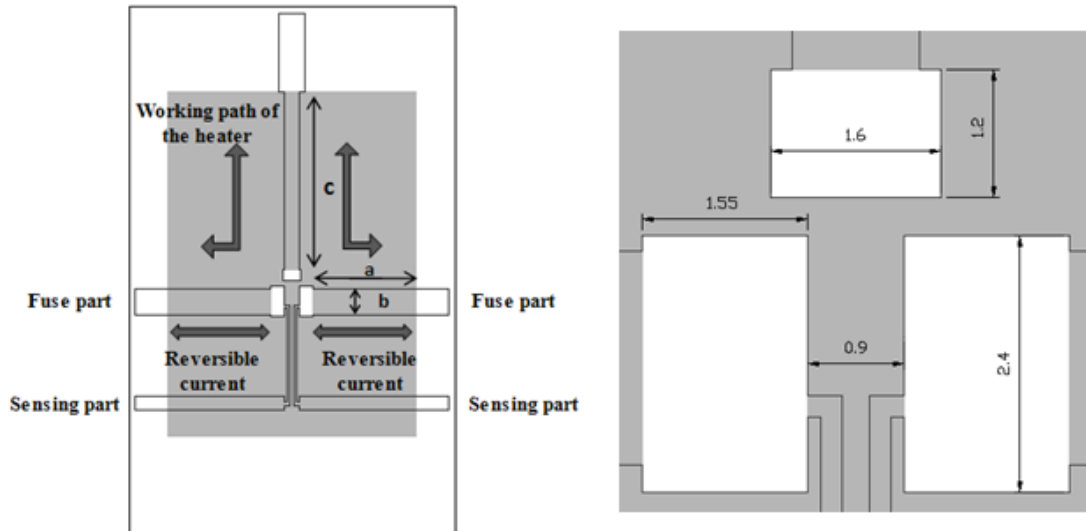

Type	a	b	c
12A	8.0	2.0	14

Unit: mm

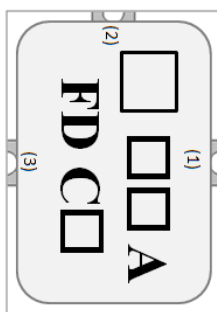

Chip setting

Packaging :

Tape packaging dimensions

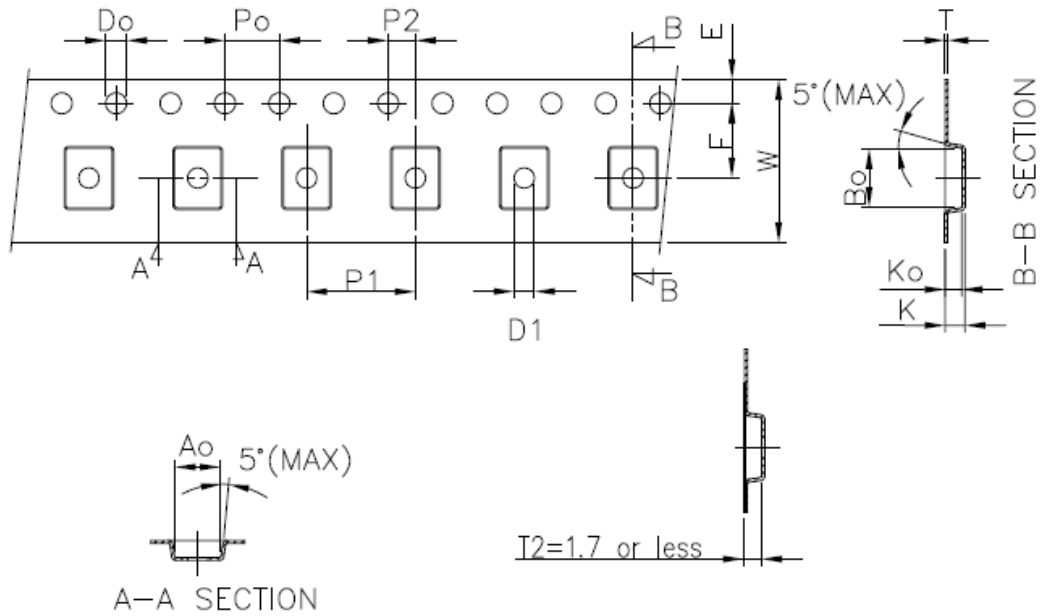

UNIT:mm

symbol	Ao	Bo	Ko	Po	P1	P2	T
spec	3.50±0.10	4.50±0.10	1.25±0.10	4.00±0.10	8.00±0.10	2.00±0.05	0.30±0.10
symbol	E	F	Do	D1	W	10Po	K
spec	1.75±0.10	5.50±0.05	1.55±0.05	1.50±0.10	12.0±0.30	40.0±0.20	1.60 or less

Direction

The direction shall be seen from the top cover tape side.

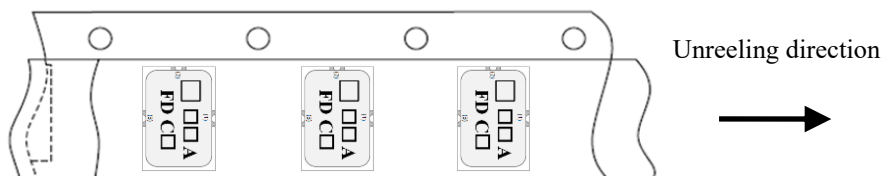

Reel dimensions

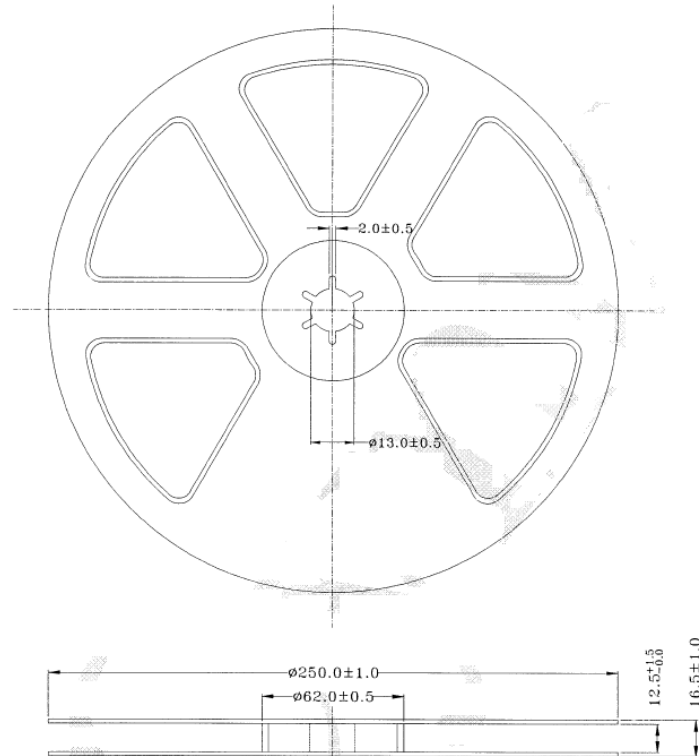

Number of Taping: 2,000 pieces/reel

Peel strength of top cover tape :

The peel speed shall be about 300mm/min.

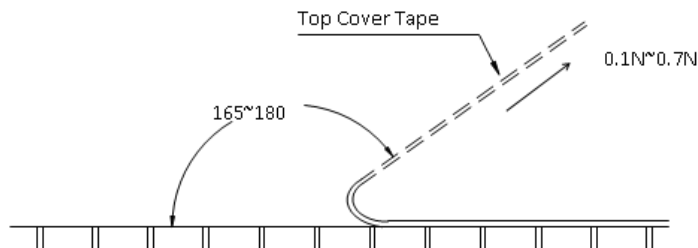
Label Marking:

The following items shall be marked on the reel:

1. Type designation
2. Quantity
3. Manufacturing date code
4. Manufacturer's name
5. The country of origin

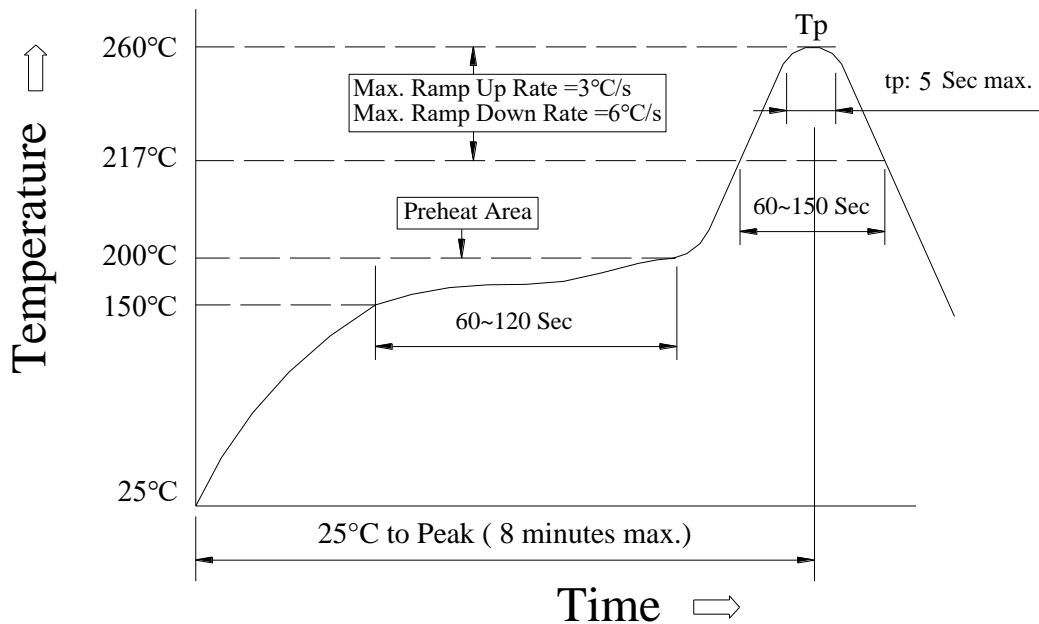
Sn plating Reflow Profile :

Reflow Soldering Method:

Reflow Soldering	Tp: 255~260°C	Max. 5 seconds
	217°C	60~150 seconds
Pre-Heat	150~200°C	60~120 seconds
Time 25°C to peak temperature	8 minutes max.	

Note: Meet JEDEC J-STD-020D

Characteristics :

Functional temperature range: -25~85°C

Operating temperature range: -10~65°C (Fusing time <1min)

Test temperature range: 25 ± 5°C

Ambient condition

Relative humidity: 45~85%

Air Pressure: 86~106kPa

Other Information :**Soldering iron method**

Bit temperature: $300 \pm 5^{\circ}\text{C}$

Application of soldering iron: 3 seconds MAX

Apply the soldering iron to the electrode.

The specimen shall be stored at standard atmospheric condition for 24h, after which the measurements shall be made. Do not suggest products for re-work.

Product storage conditions

This product should be dark and at ambient temperature is less than 40°C or relative humidity less than 60% RH place, in the above storage conditions the storage period of 6 months.

Precautions on use

Avoid contact with the resin film with this product, its resin may seep into the product, so the product does not apply to the resin material relevance, its properties can't be fully guaranteed.