

MOSFET – Power, Dual, N-Channel, For 1-2 Cells Lithium-ion Battery Protection

24 V, 11.6 mΩ, 10 A,

ECH8697R

Description

This Power MOSFET features a low on-state resistance. This device is suitable for applications such as power switches of portable machines. Best suited for 1–2 cells Lithium–ion Battery applications.

Features

- Low On–Resistance
- 2.5 V Drive
- Common–Drain Type
- ESD Diode–Protected Gate
- Built–in Gate Protection Resistor
- These Devices are Pb–Free and are RoHS Compliant

Typical Applications

- 1–2 cells Lithium–ion Battery Charging and Discharging Switch

ABSOLUTE MAXIMUM RATINGS (T_A = 25°C)

Symbol	Parameter	Value	Unit
V _{DSS}	Drain to Source Voltage	24	V
V _{GSS}	Gate to Source Voltage	±12.5	V
I _D	Drain Current (DC)	10	A
I _{DP}	Drain Current (Pulse) PW ≤ 10 μs, duty cycle ≤ 1%	60	A
P _D	Power Dissipation Surface mounted on ceramic substrate (1000 mm ² x 0.8 mm) 1 unit	1.5	W
P _T	Total Dissipation Surface mounted on ceramic substrate (1000 mm ² x 0.8 mm)	1.6	W
T _J	Junction Temperature	150	°C
T _{stg}	Storage Temperature	–55 to +150	°C

Stresses exceeding those listed in the Maximum Ratings table may damage the device. If any of these limits are exceeded, device functionality should not be assumed, damage may occur and reliability may be affected.

THERMAL CHARACTERISTICS

Symbol	Parameter	Value	Unit
R _{θJA}	Junction to Ambient Surface mounted on ceramic substrate (1000 mm ² x 0.8 mm) 1 unit	83.3	°C/W

V _{DSS}	R _{DS(on)} Max	I _D Max
24 V	11.6 mΩ @ 4.5 V	10 A
	12.6 mΩ @ 4.0 V	
	15 mΩ @ 3.1 V	
	17.5 mΩ @ 2.5 V	

ELECTRICAL CONNECTION N-Channel

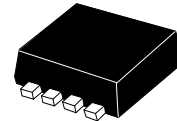
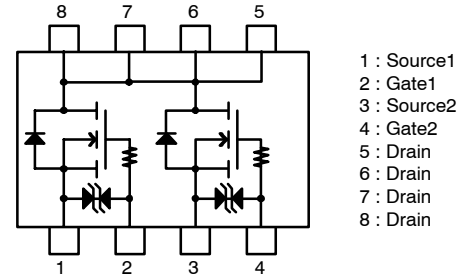

SOT-28FL/ECH8
CASE 318BF

MARKING DIAGRAM

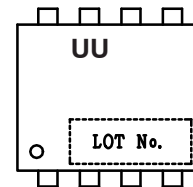

ORDERING INFORMATION

See detailed ordering and shipping information on page 5 of this data sheet.

ECH8697R

ELECTRICAL CHARACTERISTICS (T_A = 25°C)

Symbol	Parameter	Conditions	Value			Unit
			Min	Typ	Max	
V _{(BR)DSS}	Drain to Source Breakdown Voltage	I _D = 1 mA, V _{GS} = 0 V	24	–	–	V
I _{DSS}	Zero-Gate Voltage Drain Current	V _{DS} = 20 V, V _{GS} = 0 V	–	–	1	μA
I _{GSS}	Gate to Source Leakage Current	V _{GS} = ±8 V, V _{DS} = 0 V	–	–	±1	μA
V _{GS(th)}	Gate Threshold Voltage	V _{DS} = 10 V, I _D = 1 mA	0.5	–	1.3	V
g _{FS}	Forward Transconductance	V _{DS} = 10 V, I _D = 5 A	–	5.0	–	S
R _{DS(on)}	Static Drain to Source On-State Resistance	I _D = 5 A, V _{GS} = 4.5 V	7.4	9.3	11.6	mΩ
		I _D = 5 A, V _{GS} = 4.0 V	7.7	9.7	12.6	mΩ
		I _D = 5 A, V _{GS} = 3.1 V	8.5	10.7	15	mΩ
		I _D = 2.5 A, V _{GS} = 2.5 V	10	12.5	17.5	mΩ
t _{d(on)}	Turn-ON Delay Time	See Figure 1 (Note 1)	–	160	–	ns
t _r	Rise Time		–	230	–	ns
t _{d(off)}	Turn-OFF Delay Time		–	19.7	–	μs
t _f	Fall Time		–	23.6	–	μs
t _{d(on)}	Turn-ON Delay Time	See Figure 2 (Note 1)	–	160	–	ns
t _r	Rise Time		–	230	–	ns
t _{d(off)}	Turn-OFF Delay Time		–	980	–	μs
t _f	Fall Time		–	350	–	μs
Q _g	Total Gate Charge		–	6	–	nC
Q _{gs}	Gate to Source Charge	V _{DS} = 10 V, V _{GS} = 4.5 V, I _D = 10 A	–	1.1	–	nC
Q _{gd}	Gate to Drain “Miller” Charge		–	0.9	–	nC
V _{SD}	Forward Diode Voltage	I _S = 10 A, V _{GS} = 0 V	–	0.8	1.2	V

Product parametric performance is indicated in the Electrical Characteristics for the listed test conditions, unless otherwise noted. Product performance may not be indicated by the Electrical Characteristics if operated under different conditions.

1. The fall switching time is dependent on the input pulse width.

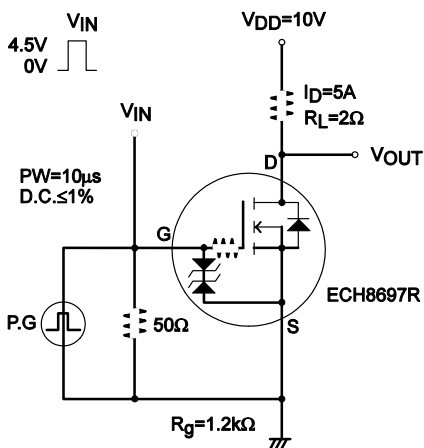

Figure 1. Switching Time Test Circuit 1

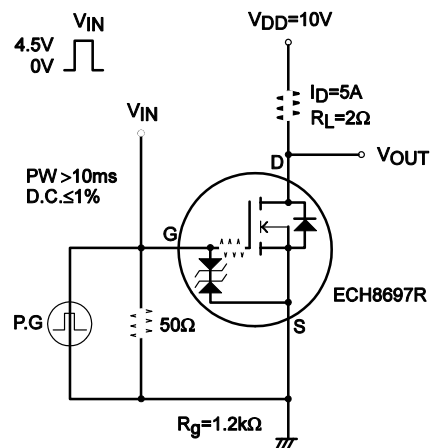

Figure 2. Switching Time Test Circuit 2

TYPICAL CHARACTERISTICS

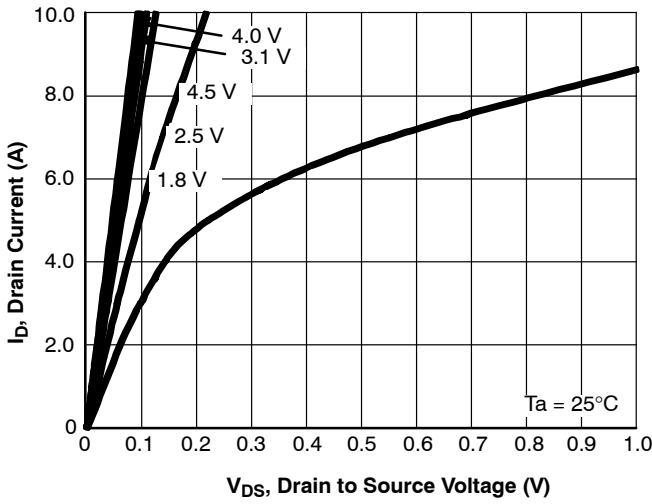

Figure 3. $I_D - V_{DS}$

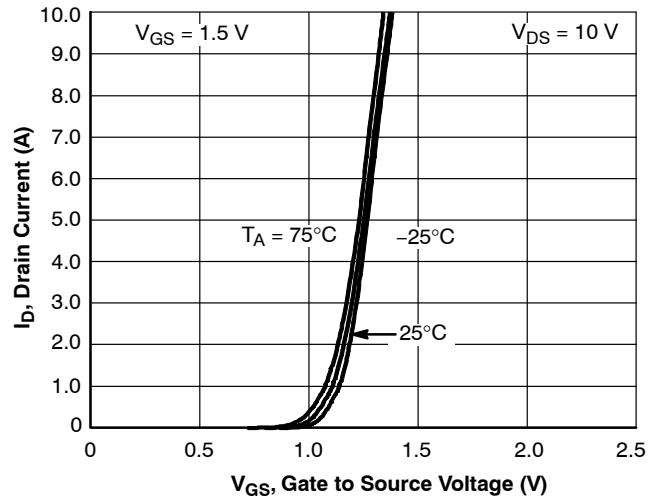

Figure 4. $I_D - V_{GS}$

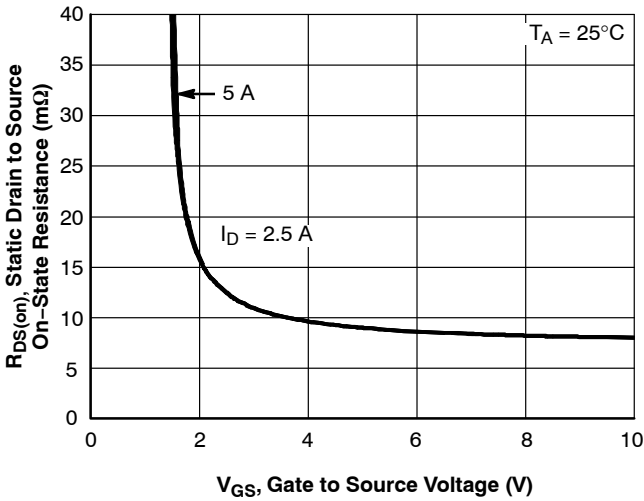

Figure 5. $R_{DS(on)} - V_{GS}$

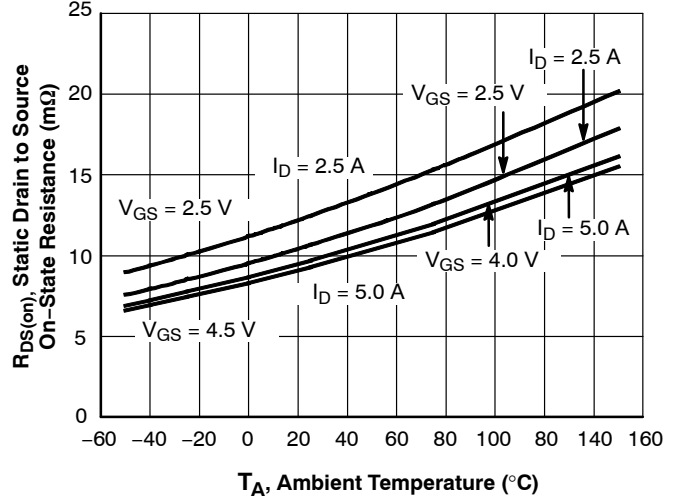

Figure 6. $R_{DS(on)} - T_A$

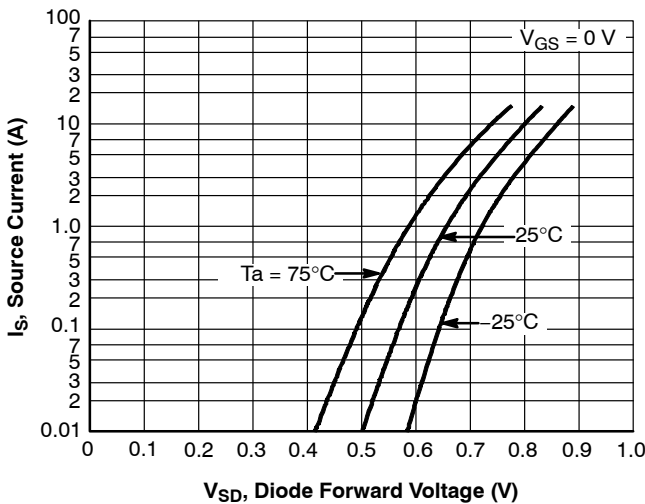

Figure 7. $I_S - V_{SD}$

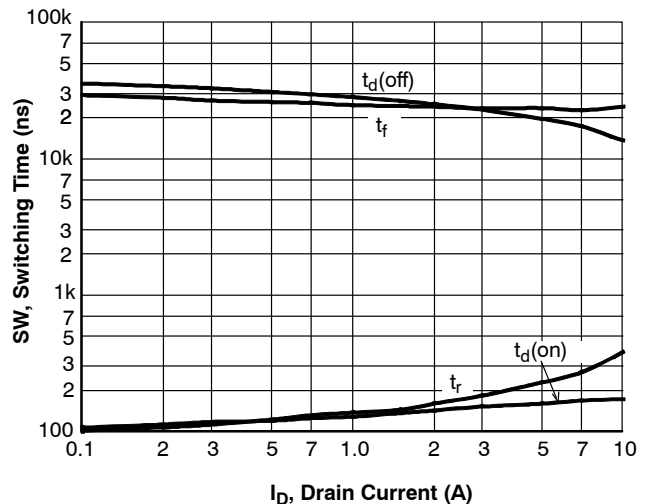

Figure 8. $I_D - S/W$ Time

TYPICAL CHARACTERISTICS (CONTINUED)

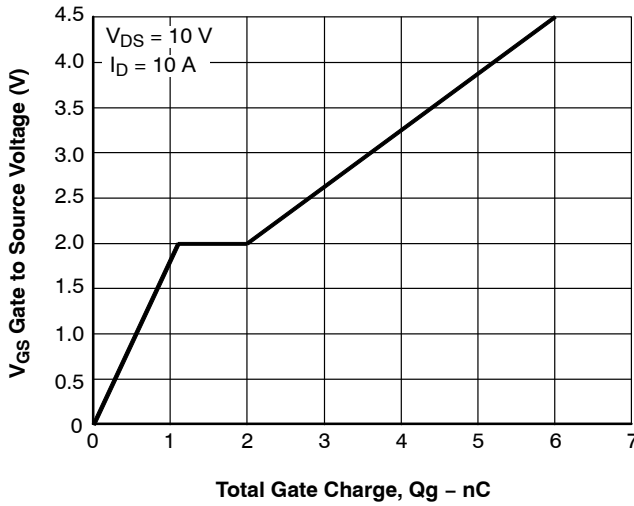

Figure 9. $V_{GS} - Q_g$

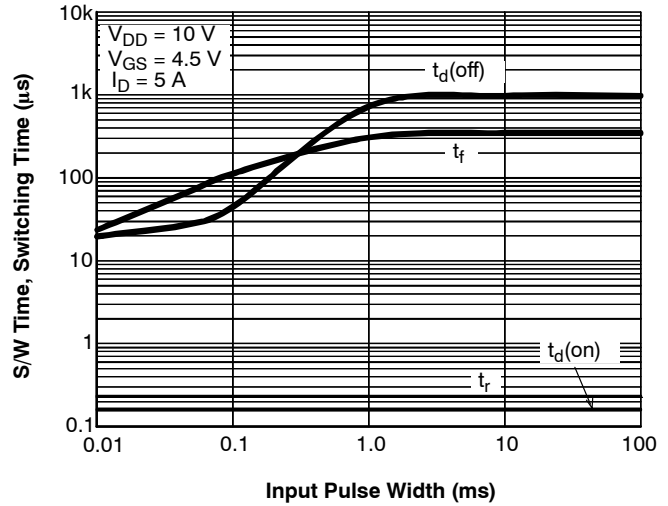

Figure 10. S/W Time - Input Pulse Width

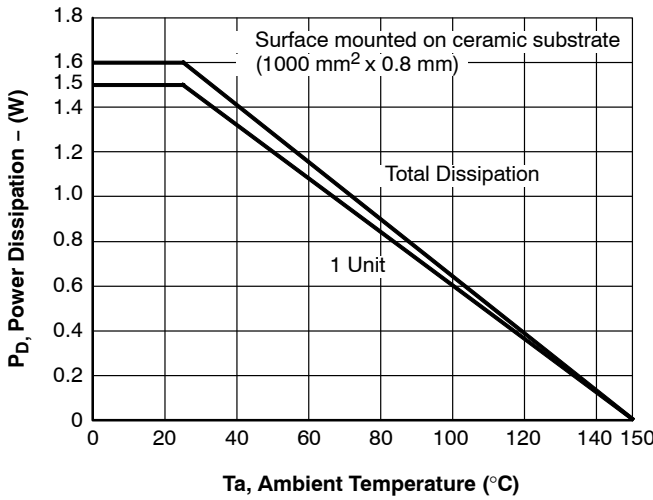

Figure 11. $P_D - T_a$

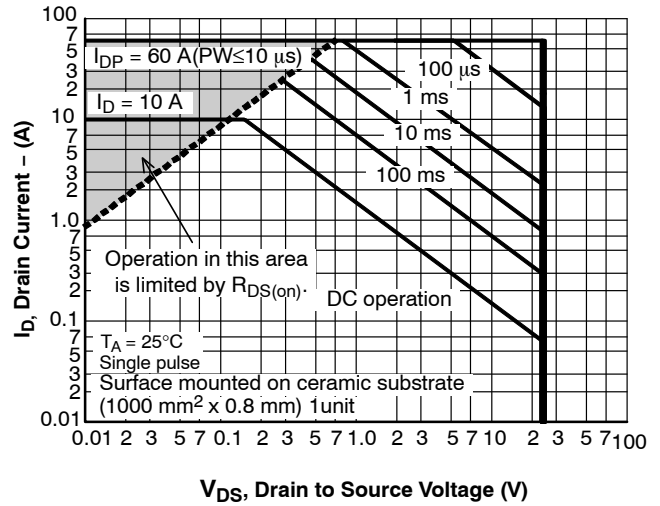

Figure 12. S O A

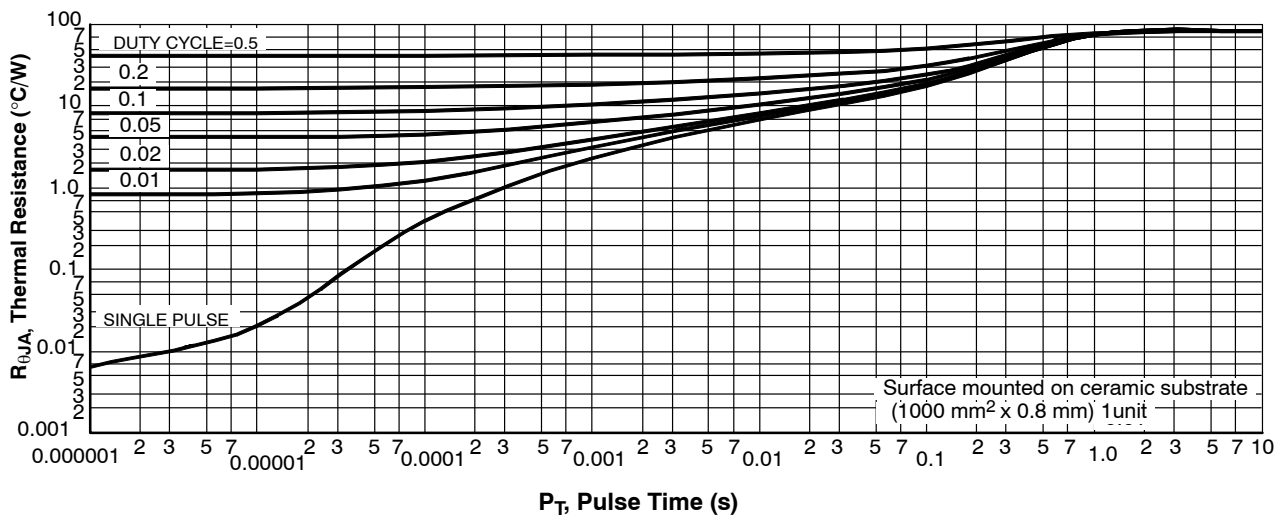

Figure 13. $R_{\theta JA} - P_{T, Pulse Time}$

ECH8697R

ORDERING INFORMATION

Product Number	Package	Shipping†
ECH8697R-TL-W	SOT-28FL, / ECH8 (Pb-Free / Halogen Free)	3000 / Tape and Reel

†For information on tape and reel specifications, including part orientation and tape sizes, please refer to our Tape and Reel Packaging Specifications Brochure, [BRD8011/D](#).

Note on usage : Since the ECH8697R is a MOSFET product, please avoid using this device in the vicinity of highly charged objects. Please contact sales for use except the designated application.

MECHANICAL CASE OUTLINE
PACKAGE DIMENSIONS

SOT-28FL / ECH8
CASE 318BF
ISSUE O

DATE 31 MAR 2012

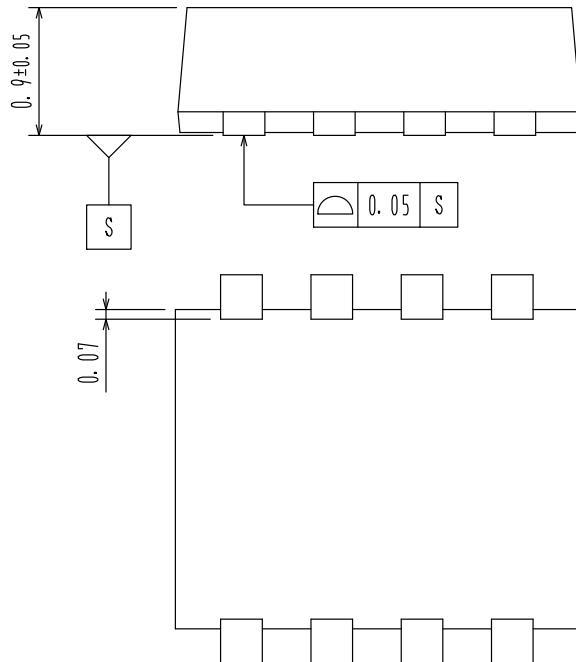
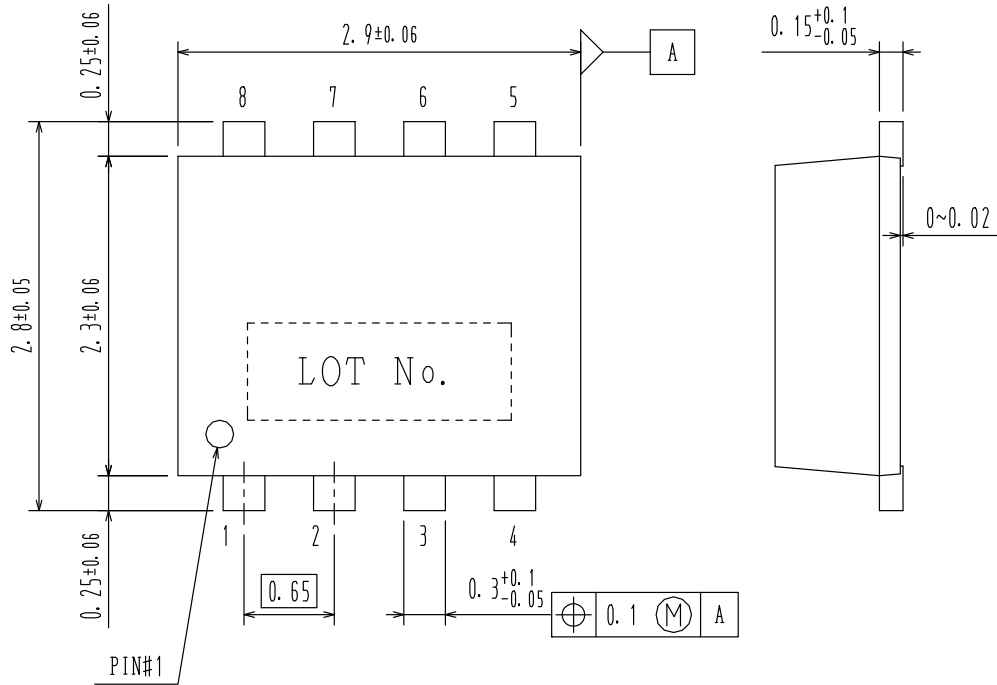

DOCUMENT NUMBER:	98AON78700E	Electronic versions are uncontrolled except when accessed directly from the Document Repository. Printed versions are uncontrolled except when stamped "CONTROLLED COPY" in red.
DESCRIPTION:	SOT-28FL / ECH8	PAGE 1 OF 1

ON Semiconductor and are trademarks of Semiconductor Components Industries, LLC dba ON Semiconductor or its subsidiaries in the United States and/or other countries. ON Semiconductor reserves the right to make changes without further notice to any products herein. ON Semiconductor makes no warranty, representation or guarantee regarding the suitability of its products for any particular purpose, nor does ON Semiconductor assume any liability arising out of the application or use of any product or circuit, and specifically disclaims any and all liability, including without limitation special, consequential or incidental damages. ON Semiconductor does not convey any license under its patent rights nor the rights of others.

onsemi, **Onsemi**, and other names, marks, and brands are registered and/or common law trademarks of Semiconductor Components Industries, LLC dba "**onsemi**" or its affiliates and/or subsidiaries in the United States and/or other countries. **onsemi** owns the rights to a number of patents, trademarks, copyrights, trade secrets, and other intellectual property. A listing of **onsemi**'s product/patent coverage may be accessed at www.onsemi.com/site/pdf/Patent-Marking.pdf. **onsemi** reserves the right to make changes at any time to any products or information herein, without notice. The information herein is provided "as-is" and **onsemi** makes no warranty, representation or guarantee regarding the accuracy of the information, product features, availability, functionality, or suitability of its products for any particular purpose, nor does **onsemi** assume any liability arising out of the application or use of any product or circuit, and specifically disclaims any and all liability, including without limitation special, consequential or incidental damages. Buyer is responsible for its products and applications using **onsemi** products, including compliance with all laws, regulations and safety requirements or standards, regardless of any support or applications information provided by **onsemi**. "Typical" parameters which may be provided in **onsemi** data sheets and/or specifications can and do vary in different applications and actual performance may vary over time. All operating parameters, including "Typicals" must be validated for each customer application by customer's technical experts. **onsemi** does not convey any license under any of its intellectual property rights nor the rights of others. **onsemi** products are not designed, intended, or authorized for use as a critical component in life support systems or any FDA Class 3 medical devices or medical devices with a same or similar classification in a foreign jurisdiction or any devices intended for implantation in the human body. Should Buyer purchase or use **onsemi** products for any such unintended or unauthorized application, Buyer shall indemnify and hold **onsemi** and its officers, employees, subsidiaries, affiliates, and distributors harmless against all claims, costs, damages, and expenses, and reasonable attorney fees arising out of, directly or indirectly, any claim of personal injury or death associated with such unintended or unauthorized use, even if such claim alleges that **onsemi** was negligent regarding the design or manufacture of the part. **onsemi** is an Equal Opportunity/Affirmative Action Employer. This literature is subject to all applicable copyright laws and is not for resale in any manner.

ADDITIONAL INFORMATION

TECHNICAL PUBLICATIONS:

Technical Library: www.onsemi.com/design/resources/technical-documentation
onsemi Website: www.onsemi.com

ONLINE SUPPORT: www.onsemi.com/support

For additional information, please contact your local Sales Representative at www.onsemi.com/support/sales