

MOSFET – Dual N-Channel, POWERTRENCH®

20 V, 1.2 A, 175 mΩ

FDG1024NZ

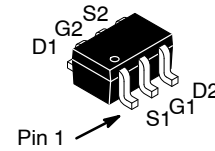

SC-88/SC-70 6 Lead, 1.25 x 2
CASE 419AD

Description

This dual N-Channel logic level enhancement mode field effect transistors are produced using onsemi's proprietary, high cell density, DMOS technology. This very high density process is especially tailored to minimize on-state resistance. This device has been designed especially for low voltage applications as a replacement for bipolar digital transistors and small signal MOSFETs. Since bias resistors are not required, this dual digital FET can replace several different digital transistors, with different bias resistor values.

Features

- Max $r_{DS(on)}$ = 175 mΩ at $V_{GS} = 4.5$ V, $I_D = 1.2$ A
- Max $r_{DS(on)}$ = 215 mΩ at $V_{GS} = 2.5$ V, $I_D = 1.0$ A
- Max $r_{DS(on)}$ = 270 mΩ at $V_{GS} = 1.8$ V, $I_D = 0.9$ A
- Max $r_{DS(on)}$ = 389 mΩ at $V_{GS} = 1.5$ V, $I_D = 0.8$ A
- HBM ESD Protection Level > 2 kV (Note 3)
- Very Low Level Gate Drive Requirements Allowing Operation in 1.5 V Circuits ($V_{GS(th)} < 1$ V)
- Very Small Package Outline SC-88/SC-70 6 Lead
- RoHS Compliant
- These Device is Halogen Free

MOSFET MAXIMUM RATINGS ($T_A = 25^\circ\text{C}$ unless otherwise noted)

Symbol	Parameter	Ratings	Unit	
V_{DS}	Drain to Source Voltage	20	V	
V_{GS}	Gate to Source Voltage	±8	V	
I_D	Drain Current	Continuous $T_A = 25^\circ\text{C}$ (Note 1a)	1.2	A
		Pulsed	6	
P_D	Power Dissipation	$T_A = 25^\circ\text{C}$ (Note 1a)	0.36	W
		$T_A = 25^\circ\text{C}$ (Note 1b)	0.30	
T_J, T_{STG}	Operating and Storage Junction Temperature Range	-55 to +150	$^\circ\text{C}$	

Stresses exceeding those listed in the Maximum Ratings table may damage the device. If any of these limits are exceeded, device functionality should not be assumed, damage may occur and reliability may be affected.

MARKING DIAGRAM

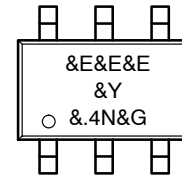

- &E = Designates Space
- &Y = Binary Calendar Year
- &.4N = Specific Device Code
- &G = 1-Digit Weekly Date Code

ELECTRICAL CONNECTION

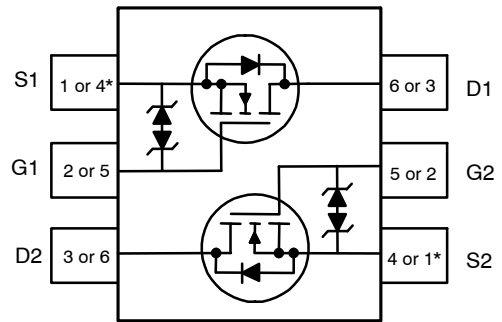

N-Channel MOSFET

* The pinouts are symmetrical; pin 1 and 4 are interchangeable.
Units inside the carrier can be of either orientation and will not affect the functionality of the device.

ORDERING INFORMATION

See detailed ordering and shipping information on page 3 of this data sheet.

FDG1024NZ

THERMAL CHARACTERISTICS

Symbol	Parameter	Ratings	Unit
$R_{\theta JA}$	Thermal Resistance, Junction to Ambient (Note 1a)	350	°C/W
$R_{\theta JA}$	Thermal Resistance, Junction to Ambient (Note 1b)	415	

ELECTRICAL CHARACTERISTICS ($T_J = 25^\circ\text{C}$ unless otherwise noted)

Symbol	Parameter	Test Conditions	Min.	Typ.	Max.	Unit
--------	-----------	-----------------	------	------	------	------

OFF CHARACTERISTICS

BV_{DSS}	Drain to Source Breakdown Voltage	$I_D = 250 \mu\text{A}, V_{GS} = 0 \text{V}$	20	-	-	V
$\frac{\Delta BV_{DSS}}{\Delta T_J}$	Breakdown Voltage Temperature Coefficient	$I_D = 250 \mu\text{A}$, referenced to 25°C	-	14	-	mV/°C
I_{DSS}	Zero Gate Voltage Drain Current	$V_{DS} = 16 \text{V}, V_{GS} = 0 \text{V}$	-	-	1	μA
I_{GSS}	Gate to Source Leakage Current	$V_{GS} = \pm 8 \text{V}, V_{DS} = 0 \text{V}$	-	-	± 10	μA

ON CHARACTERISTICS

$V_{GS(th)}$	Gate to Source Threshold Voltage	$V_{GS} = V_{DS}, I_D = 250 \mu\text{A}$	0.4	0.8	1.0	V
$\frac{\Delta V_{GS(th)}}{\Delta T_J}$	Gate to Source Threshold Voltage Temperature Coefficient	$I_D = 250 \mu\text{A}$, referenced to 25°C	-	-3	-	mV/°C
$r_{DS(on)}$	Static Drain to Source On Resistance	$V_{GS} = 4.5 \text{V}, I_D = 1.2 \text{A}$	-	160	175	m Ω
		$V_{GS} = 2.5 \text{V}, I_D = 1.0 \text{A}$	-	185	215	
		$V_{GS} = 1.8 \text{V}, I_D = 0.9 \text{A}$	-	232	270	
		$V_{GS} = 1.5 \text{V}, I_D = 0.8 \text{A}$	-	321	389	
		$V_{GS} = 4.5 \text{V}, I_D = 1.2 \text{A}, T_J = 125^\circ\text{C}$	-	220	259	
g_{FS}	Forward Transconductance	$V_{DD} = 5 \text{V}, I_D = 1.2 \text{A}$	-	4	-	S

DYNAMIC CHARACTERISTICS

C_{ISS}	Input Capacitance	$V_{DS} = 10 \text{V}, V_{GS} = 0 \text{V},$ $f = 1 \text{MHz}$	-	115	150	pF
C_{OSS}	Output Capacitance		-	25	35	pF
C_{rss}	Reverse Transfer Capacitance		-	20	25	pF
R_g	Gate Resistance		-	4.6	-	Ω

SWITCHING CHARACTERISTICS

$t_{d(on)}$	Turn-On Delay Time	$V_{DD} = 10 \text{V}, I_D = 1.2 \text{A},$ $V_{GS} = 4.5 \text{V}, R_{GEN} = 6 \Omega$	-	3.7	10	ns
t_r	Rise Time		-	1.7	10	ns
$t_{d(off)}$	Turn-Off Delay Time		-	11	19	ns
t_f	Fall Time		-	1.5	10	ns
Q_g	Total Gate Charge	$V_{GS} = 4.5 \text{V}, V_{DD} = 10 \text{V}, I_D = 1.2 \text{A}$	-	1.8	2.6	nC
Q_{gs}	Gate to Source Charge		-	0.3	-	nC
Q_{gd}	Gate to Drain "Miller" Charge		-	0.4	-	nC

DRAIN-SOURCE DIODE CHARACTERISTICS

I_S	Maximum Continuous Drain-Source Diode Forward Current	-	-	0.3	A	
V_{SD}	Source to Drain Diode Forward Voltage	$V_{GS} = 0 \text{V}, I_S = 0.3 \text{A}$ (Note 2)	-	0.7	1.2	V
t_{rr}	Reverse Recovery Time	$I_F = 1.2 \text{A}, di/dt = 100 \text{A}/\mu\text{s}$	-	10	20	ns
Q_{rr}	Reverse Recovery Charge		-	1.9	10	nC

Product parametric performance is indicated in the Electrical Characteristics for the listed test conditions, unless otherwise noted. Product performance may not be indicated by the Electrical Characteristics if operated under different conditions.

FDG1024NZ

NOTES:

1. $R_{\theta JA}$ is determined with the device mounted on a 1 in² pad 2 oz copper pad on a 1.5 x 1.5 in. board of FR-4 material. $R_{\theta JC}$ is guaranteed by design while $R_{\theta JA}$ is determined by the user's board design.



a. 350°C/W when mounted on a 1 in² pad of 2 oz copper

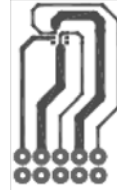

b. 415°C/W when mounted on a minimum pad of 2 oz copper

2. Pulse Test: Pulse Width < 300 μ s, Duty cycle < 2.0%.
3. The diode connected between the gate and source serves only as protection against ESD. No gate overvoltage rating is implied.

PACKAGE MARKING AND ORDERING INFORMATION

ORDERING INFORMATION

Device Marking	Device	Package	Reel Size	Tape Width	Shipping [†]
.4N	FDG1024NZ	SC-88/SC-70 6 Lead (Halogen Free)	7"	8 mm	3000 / Tape and Reel

[†]For information on tape and reel specifications, including part orientation and tape sizes, please refer to our Tape and Reel Packaging Specification Brochure, BRD8011/D.

FDG1024NZ

TYPICAL CHARACTERISTICS

($T_J = 25^\circ\text{C}$ unless otherwise noted)

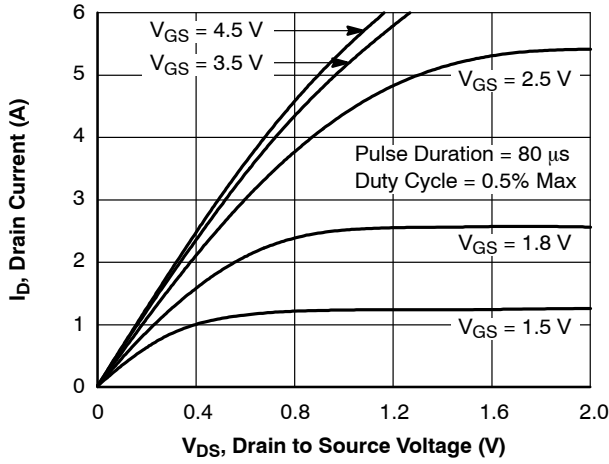

Figure 1. On-Region Characteristics

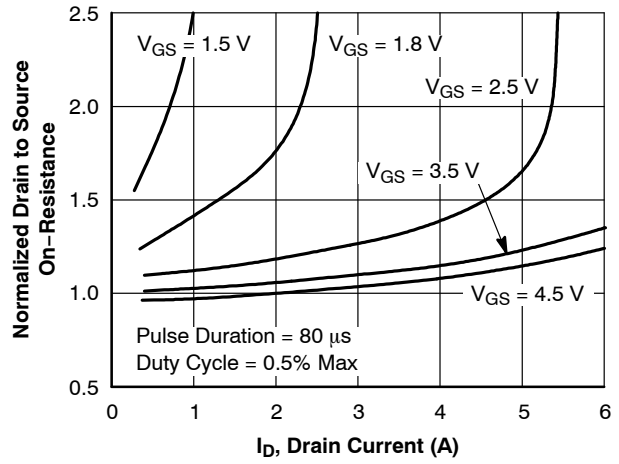

Figure 2. Normalized On-Resistance vs. Drain Current and Gate Voltage

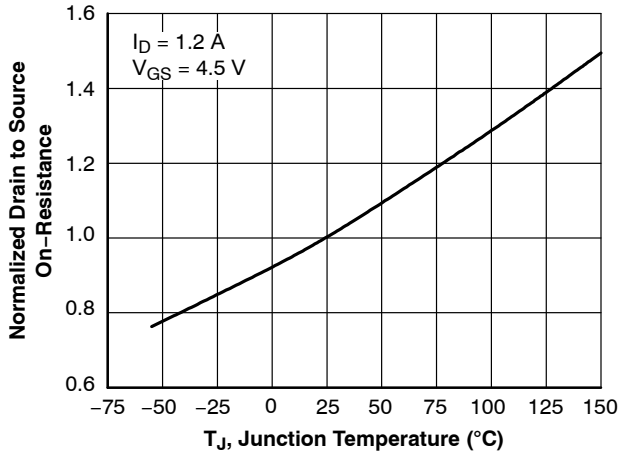

Figure 3. Normalized On-Resistance vs. Junction Temperature

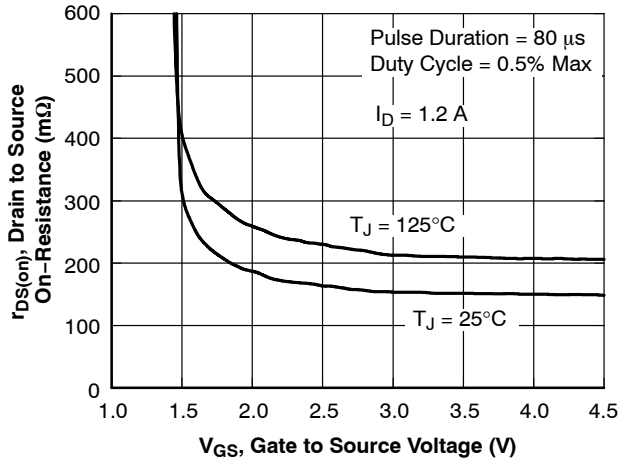

Figure 4. On-Resistance vs. Gate to Source Voltage

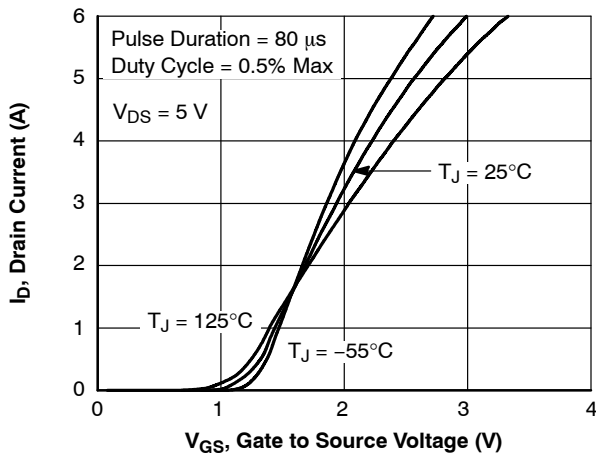

Figure 5. Transfer Characteristics

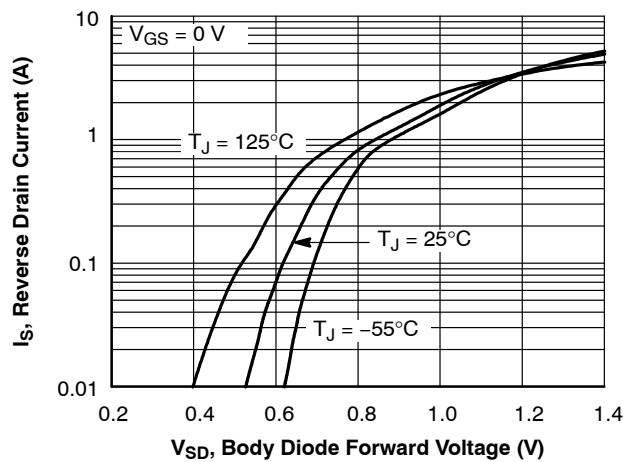

Figure 6. Source to Drain Diode Forward Voltage vs. Source Current

FDG1024NZ

TYPICAL CHARACTERISTICS (continued)

($T_J = 25^\circ\text{C}$ unless otherwise noted)

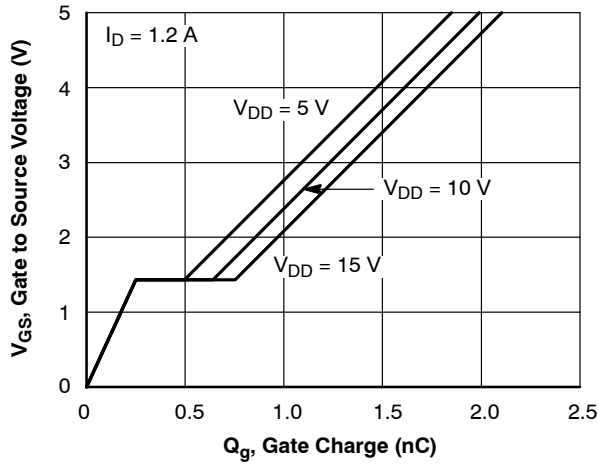

Figure 7. Gate Charge Characteristics

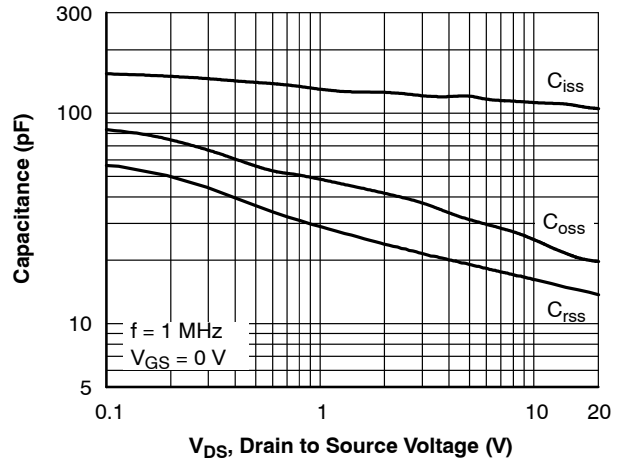

Figure 8. Capacitance vs. Drain to Source Voltage

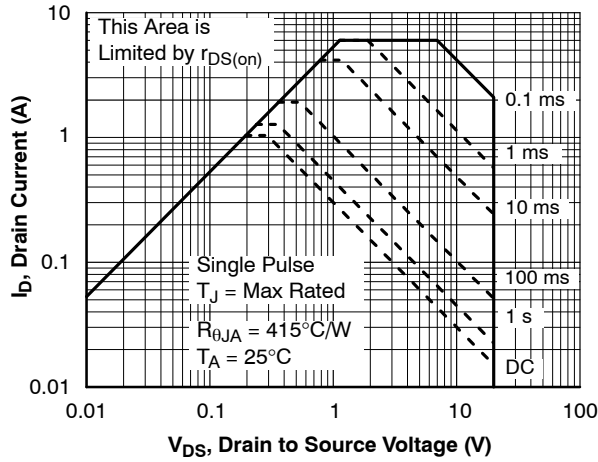

Figure 9. Forward Bias Safe Operating Area

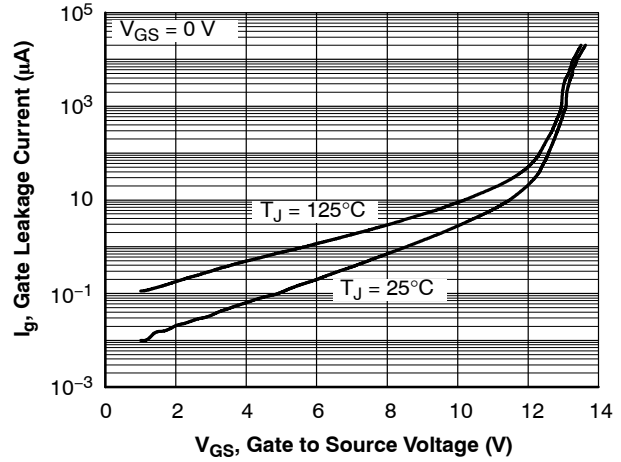

Figure 10. Gate Leakage Current vs. Gate to Source Voltage

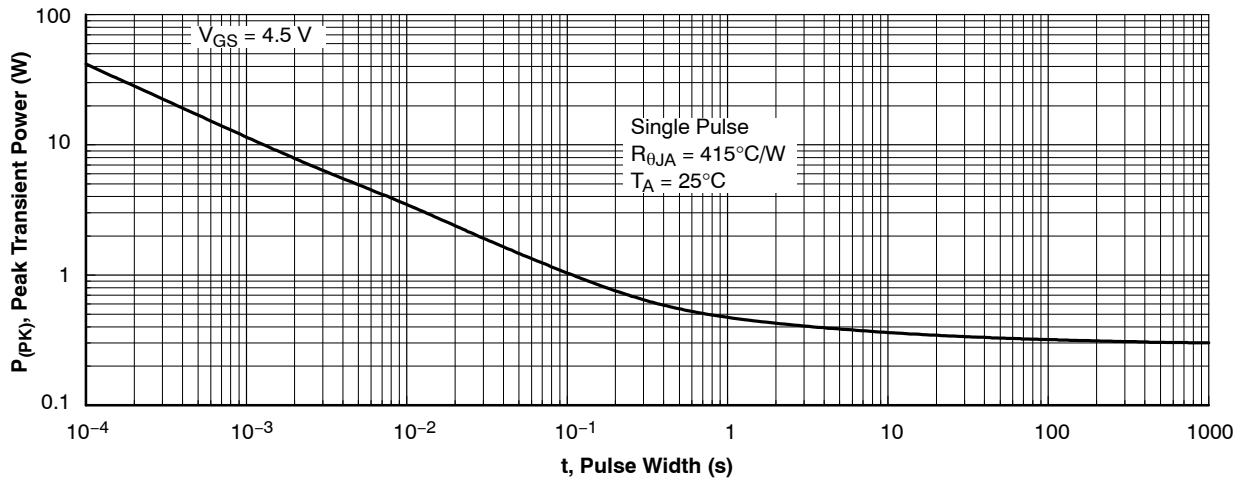

Figure 11. Single Pulse Maximum Power Dissipation

FDG1024NZ

TYPICAL CHARACTERISTICS (continued)

($T_J = 25^\circ\text{C}$ unless otherwise noted)

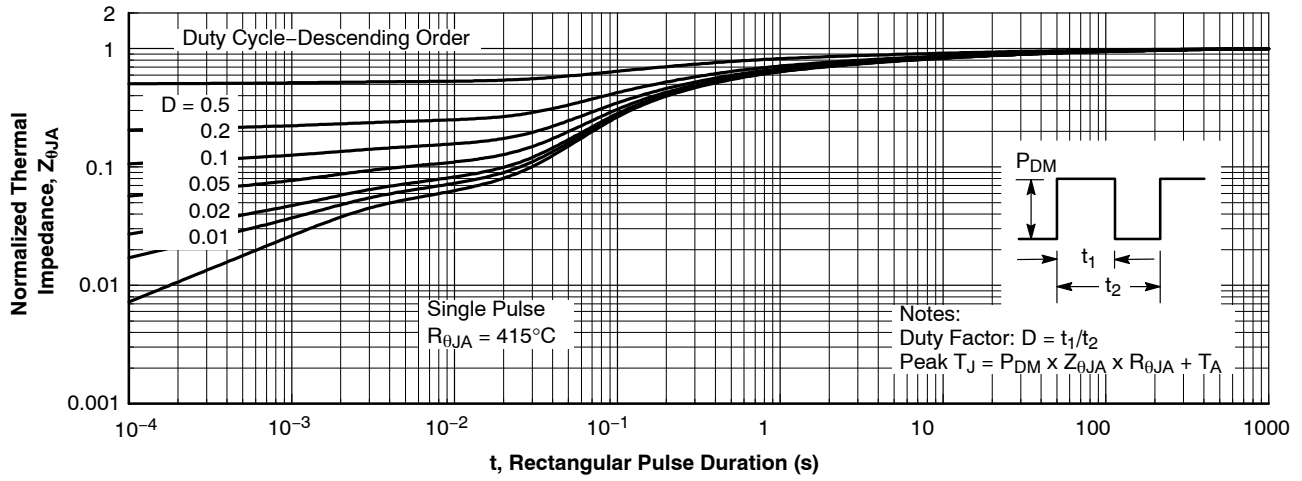
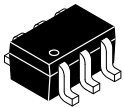

Figure 12. Transient Thermal Response Curve

POWERTRENCH is a registered trademark of Semiconductor Components Industries, LLC dba "onsemi" or its affiliates and/or subsidiaries in the United States and/or other countries.

MECHANICAL CASE OUTLINE
PACKAGE DIMENSIONS



1

SC-88 (SC-70 6 Lead), 1.25x2
CASE 419AD
ISSUE A

DATE 07 JUL 2010

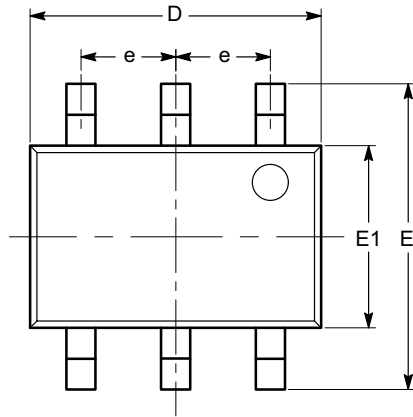

TOP VIEW

SYMBOL	MIN	NOM	MAX
A	0.80		1.10
A1	0.00		0.10
A2	0.80		1.00
b	0.15		0.30
c	0.10		0.18
D	1.80	2.00	2.20
E	1.80	2.10	2.40
E1	1.15	1.25	1.35
e	0.65 BSC		
L	0.26	0.36	0.46
L1	0.42 REF		
L2	0.15 BSC		
θ	0°		8°
θ_1	4°		10°

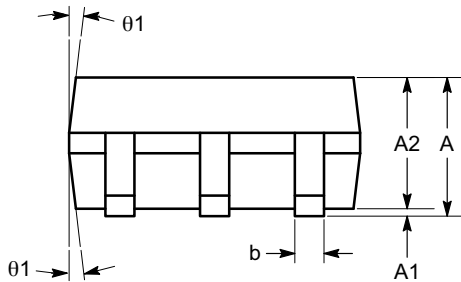

SIDE VIEW

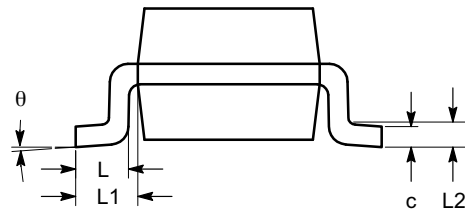

END VIEW

Notes:

- (1) All dimensions are in millimeters. Angles in degrees.
- (2) Complies with JEDEC MO-203.

DOCUMENT NUMBER:	98AON34266E	Electronic versions are uncontrolled except when accessed directly from the Document Repository. Printed versions are uncontrolled except when stamped "CONTROLLED COPY" in red.
DESCRIPTION:	SC-88 (SC-70 6 LEAD), 1.25X2	PAGE 1 OF 1

onsemi and ONSEMI are trademarks of Semiconductor Components Industries, LLC dba onsemi or its subsidiaries in the United States and/or other countries. onsemi reserves the right to make changes without further notice to any products herein. onsemi makes no warranty, representation or guarantee regarding the suitability of its products for any particular purpose, nor does onsemi assume any liability arising out of the application or use of any product or circuit, and specifically disclaims any and all liability, including without limitation special, consequential or incidental damages. onsemi does not convey any license under its patent rights nor the rights of others.

onsemi, **Onsemi**, and other names, marks, and brands are registered and/or common law trademarks of Semiconductor Components Industries, LLC dba "**onsemi**" or its affiliates and/or subsidiaries in the United States and/or other countries. **onsemi** owns the rights to a number of patents, trademarks, copyrights, trade secrets, and other intellectual property. A listing of **onsemi**'s product/patent coverage may be accessed at www.onsemi.com/site/pdf/Patent-Marking.pdf. **onsemi** reserves the right to make changes at any time to any products or information herein, without notice. The information herein is provided "as-is" and **onsemi** makes no warranty, representation or guarantee regarding the accuracy of the information, product features, availability, functionality, or suitability of its products for any particular purpose, nor does **onsemi** assume any liability arising out of the application or use of any product or circuit, and specifically disclaims any and all liability, including without limitation special, consequential or incidental damages. Buyer is responsible for its products and applications using **onsemi** products, including compliance with all laws, regulations and safety requirements or standards, regardless of any support or applications information provided by **onsemi**. "Typical" parameters which may be provided in **onsemi** data sheets and/or specifications can and do vary in different applications and actual performance may vary over time. All operating parameters, including "Typicals" must be validated for each customer application by customer's technical experts. **onsemi** does not convey any license under any of its intellectual property rights nor the rights of others. **onsemi** products are not designed, intended, or authorized for use as a critical component in life support systems or any FDA Class 3 medical devices or medical devices with a same or similar classification in a foreign jurisdiction or any devices intended for implantation in the human body. Should Buyer purchase or use **onsemi** products for any such unintended or unauthorized application, Buyer shall indemnify and hold **onsemi** and its officers, employees, subsidiaries, affiliates, and distributors harmless against all claims, costs, damages, and expenses, and reasonable attorney fees arising out of, directly or indirectly, any claim of personal injury or death associated with such unintended or unauthorized use, even if such claim alleges that **onsemi** was negligent regarding the design or manufacture of the part. **onsemi** is an Equal Opportunity/Affirmative Action Employer. This literature is subject to all applicable copyright laws and is not for resale in any manner.

ADDITIONAL INFORMATION

TECHNICAL PUBLICATIONS:

Technical Library: www.onsemi.com/design/resources/technical-documentation
onsemi Website: www.onsemi.com

ONLINE SUPPORT: www.onsemi.com/support

For additional information, please contact your local Sales Representative at www.onsemi.com/support/sales