



General Description

The AO6808 uses advanced trench technology to provide excellent $R_{DS(ON)}$, low gate charge and operation with gate voltages as low as 2.5V. This device is suitable for use as a load switch. It is ESD protected.

Product Summary

$V_{DS} = 20V$
 $I_D = 6A$
 $R_{DS(ON)} = 19m\Omega$ (typical) ($V_{GS} = 4.5V$)
 $R_{DS(ON)} = 20m\Omega$ (typical) ($V_{GS} = 4.0V$)
 $R_{DS(ON)} = 21m\Omega$ (typical) ($V_{GS} = 3.1V$)
 $R_{DS(ON)} = 23m\Omega$ (typical) ($V_{GS} = 2.5V$)

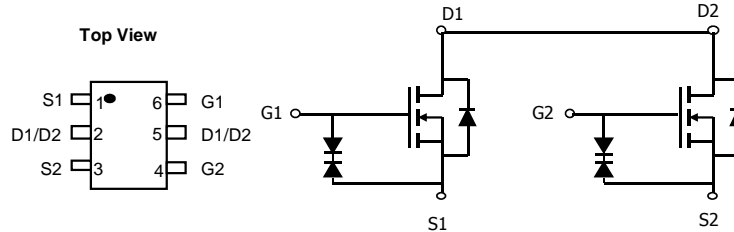
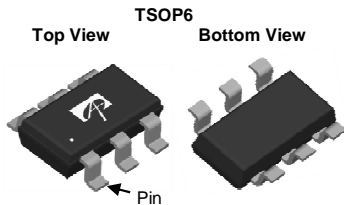

Absolute Maximum Ratings $T_A=25^\circ C$ unless otherwise noted

Parameter	Symbol	10 Sec	Steady State	Units
Drain-Source Voltage	V_{DS}	20		V
Gate-Source Voltage	V_{GS}	± 12		V
Continuous Drain Current ^A	I_D	6	4.6	A
$T_A=25^\circ C$		4.6	3.7	
Pulsed Drain Current ^B	I_{DM}	60		
Power Dissipation ^A	P_D	1.3	0.8	W
		$T_A=25^\circ C$	0.8	
Junction and Storage Temperature Range	T_J, T_{STG}	-55 to 150		$^\circ C$

Thermal Characteristics

Parameter		Symbol	Typ	Max	Units
Maximum Junction-to-Ambient ^A	$t \leq 10s$	$R_{\theta JA}$	76	95	$^\circ C/W$
Maximum Junction-to-Ambient ^A	Steady State		118	150	$^\circ C/W$
Maximum Junction-to-Lead ^C	Steady State	$R_{\theta JL}$	54	68	$^\circ C/W$

Electrical Characteristics (T_J=25°C unless otherwise noted)

Symbol	Parameter	Conditions	Min	Typ	Max	Units
STATIC PARAMETERS						
BV _{DSS}	Drain-Source Breakdown Voltage	I _D = 250μA, V _{GS} = 0V	20			V
I _{DSS}	Zero Gate Voltage Drain Current	V _{DS} = 20V, V _{GS} = 0V T _J = 55°C			1 5	μA
I _{GSS}	Gate-Body leakage current	V _{DS} = 0V, V _{GS} = ±10V			±10	μA
V _{GS(th)}	Gate Threshold Voltage	V _{DS} = V _{GS} , I _D = 250μA	0.5	0.75	1	V
I _{D(ON)}	On state drain current	V _{GS} = 4.5V, V _{DS} = 5V	60			A
R _{DS(ON)}	Static Drain-Source On-Resistance	V _{GS} = 4.5V, I _D = 6.0A T _J = 125°C	15 21	19 27	23 33	mΩ
		V _{GS} = 4.0V, I _D = 5.5A	15	20	25	
		V _{GS} = 3.1V, I _D = 5A	16	21	27	mΩ
		V _{GS} = 2.5V, I _D = 2A	17	23	30	mΩ
g _{FS}	Forward Transconductance	V _{DS} = 5V, I _D = 6.0A		34		S
V _{SD}	Diode Forward Voltage	I _S = 1A, V _{GS} = 0V		0.65	1	V
I _S	Maximum Body-Diode Continuous Current				1.3	A
DYNAMIC PARAMETERS						
C _{ISS}	Input Capacitance	V _{GS} = 0V, V _{DS} = 10V, f = 1MHz		620	780	pF
C _{OSS}	Output Capacitance			125		pF
C _{RSS}	Reverse Transfer Capacitance			64		pF
SWITCHING PARAMETERS						
Q _g (10V)	Total Gate Charge	V _{GS} = 10V, V _{DS} = 10V, I _D = 6A		16.2	21	nC
Q _g (4.5V)	Total Gate Charge			7.7	10	nC
Q _{gs}	Gate Source Charge			1.5		nC
Q _{gd}	Gate Drain Charge			2.7		nC
t _{D(on)}	Turn-On Delay Time	V _{GS} = 10V, V _{DS} = 10V, R _L = 1.7Ω, R _{GEN} = 3Ω		236		ns
t _r	Turn-On Rise Time			448		ns
t _{D(off)}	Turn-Off Delay Time			9.5		μs
t _f	Turn-Off Fall Time			4.1		μs
t _{rr}	Body Diode Reverse Recovery Time	I _F = 6A, di/dt = 100A/μs		25	33	ns
Q _{rr}	Body Diode Reverse Recovery Charge	I _F = 6A, di/dt = 100A/μs		9		nC

A: The value of R_{θJA} is measured with the device mounted on 1in² FR-4 board with 2oz. Copper, in a still air environment with T_A = 25° C. in any given application depends on the user's specific board design. The current rating is based on the t ≤ 10s thermal resistance rating.

B: Repetitive rating, pulse width limited by junction temperature.

C: The R_{θJA} is the sum of the thermal impedance from junction to lead R_{θJL} and lead to ambient.

D: The static characteristics in Figures 1 to 6 are obtained using < 300μs pulses, duty cycle 0.5% max.

E: These tests are performed with the device mounted on 1 in² FR-4 board with 2oz. Copper, in a still air environment with T_A = 25° C. The SOA curve provides a single pulse rating.

THIS PRODUCT HAS BEEN DESIGNED AND QUALIFIED FOR THE CONSUMER MARKET. APPLICATIONS OR USES AS CRITICAL COMPONENTS IN LIFE SUPPORT DEVICES OR SYSTEMS ARE NOT AUTHORIZED. AOS DOES NOT ASSUME ANY LIABILITY ARISING OUT OF SUCH APPLICATIONS OR USES OF ITS PRODUCTS. AOS RESERVES THE RIGHT TO IMPROVE PRODUCT DESIGN, FUNCTIONS AND RELIABILITY WITHOUT NOTICE.

TYPICAL ELECTRICAL AND THERMAL CHARACTERISTICS

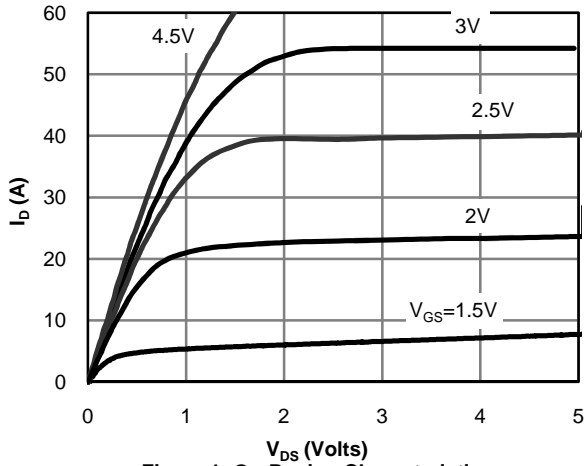

Figure 1: On-Region Characteristics

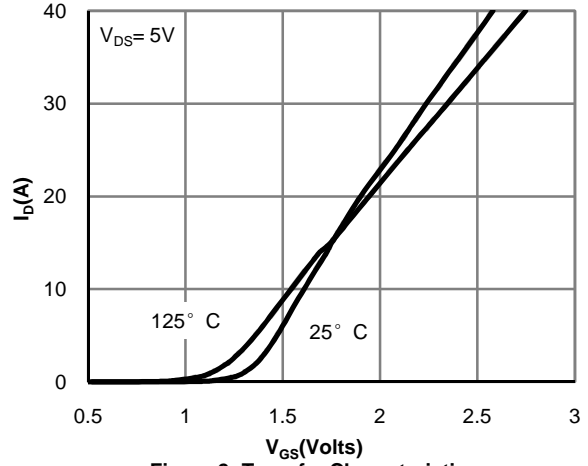

Figure 2: Transfer Characteristics

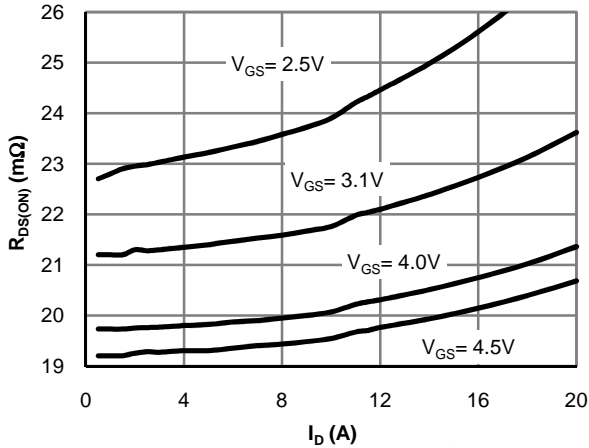

Figure 3: On-Resistance vs. Drain Current and Gate Voltage

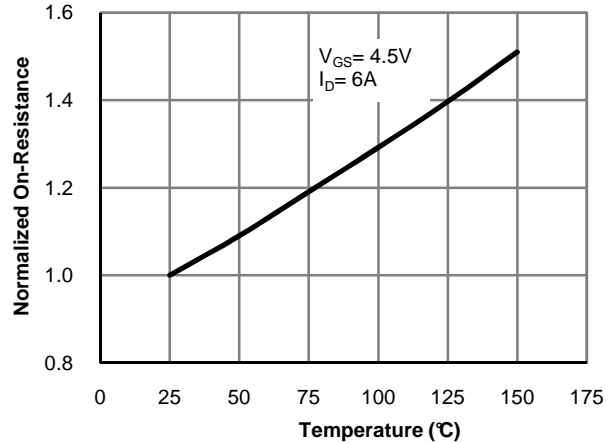

Figure 4: On-Resistance vs. Junction Temperature

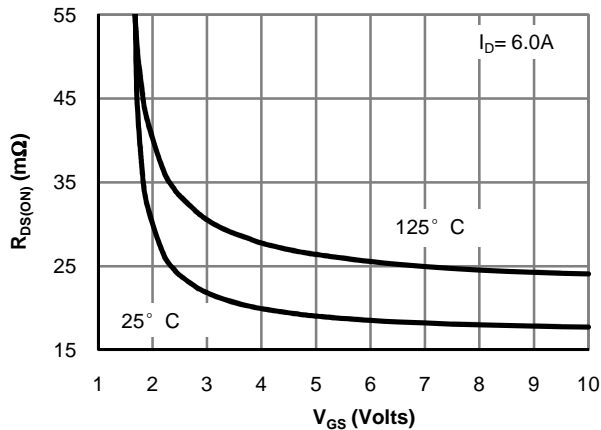

Figure 5: On-Resistance vs. Gate-Source Voltage

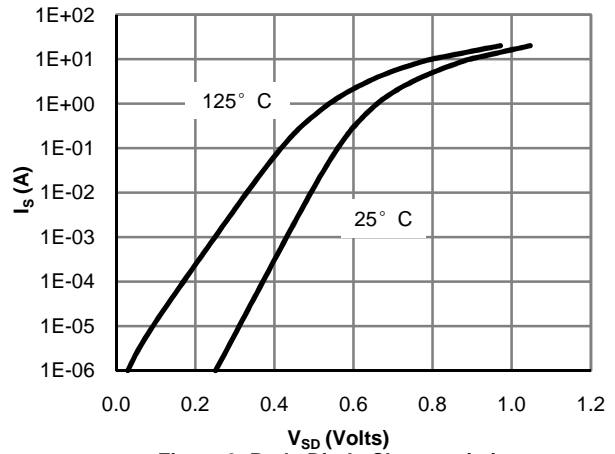
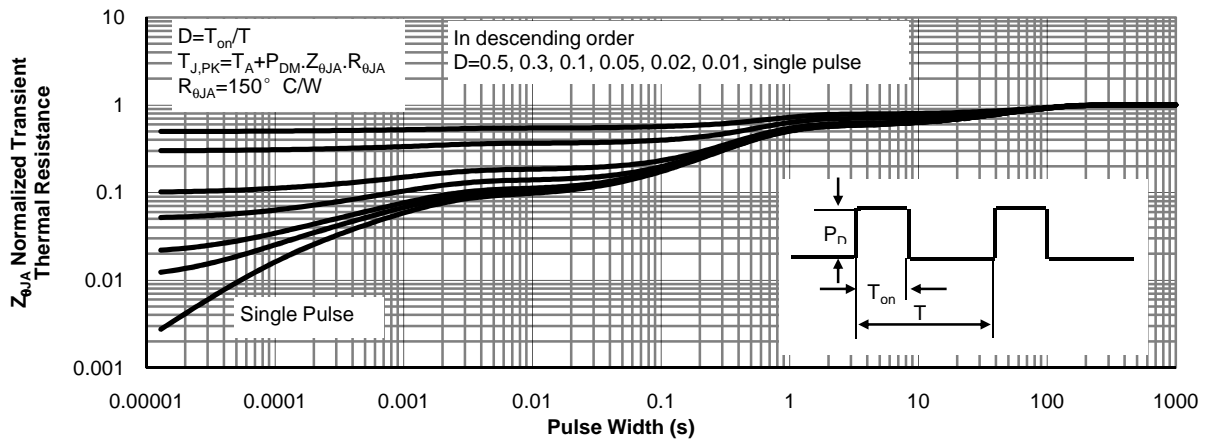
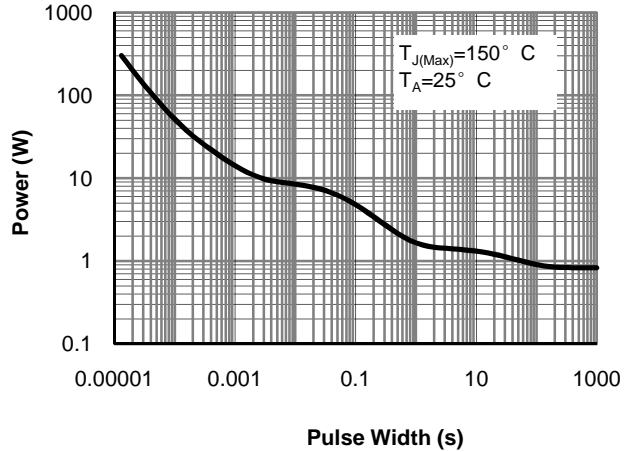
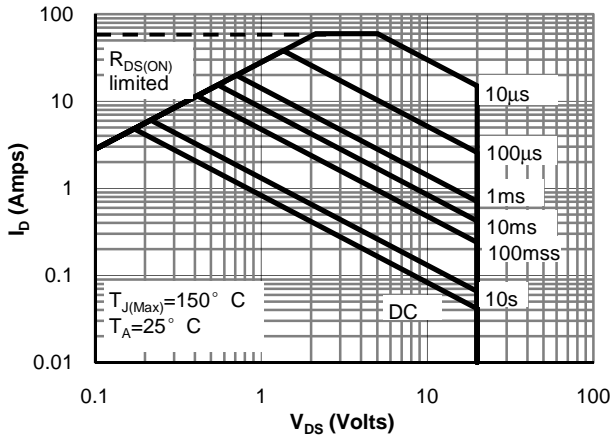
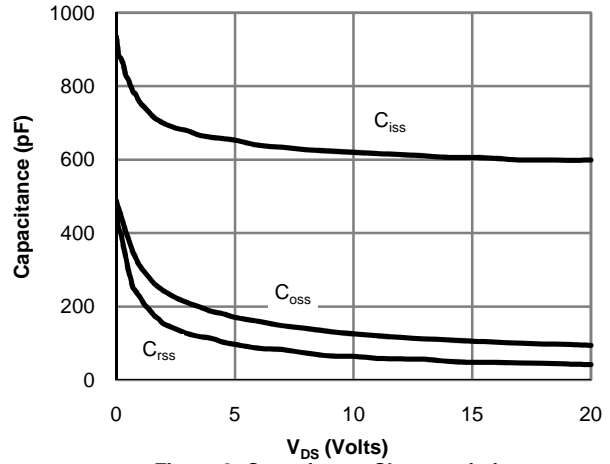
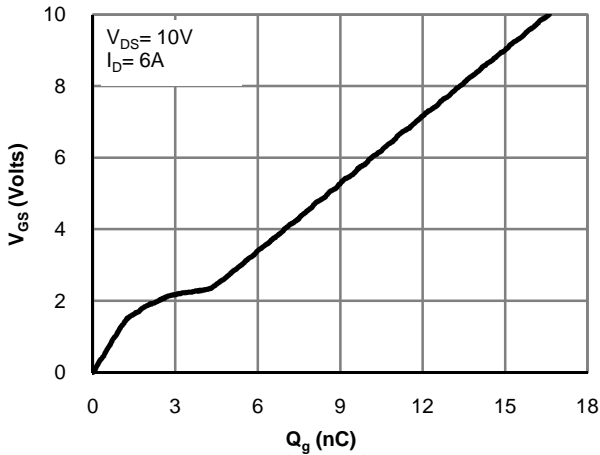
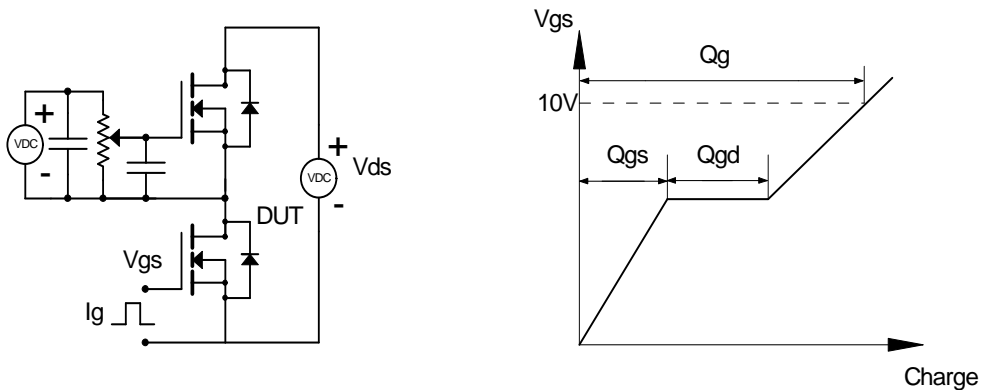

Figure 6: Body-Diode Characteristics

TYPICAL ELECTRICAL AND THERMAL CHARACTERISTICS



Gate Charge Test Circuit & Waveform



Resistive Switching Test Circuit & Waveforms

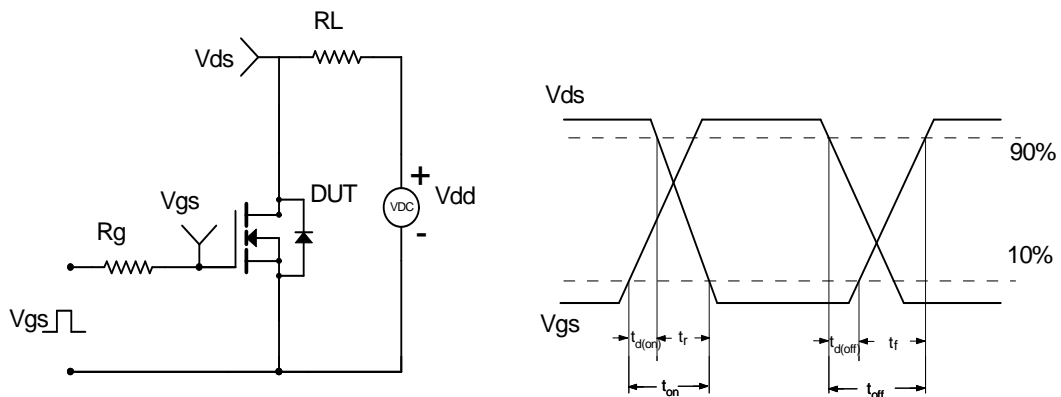

Unclamped Inductive Switching (UIS) Test Circuit & Waveforms

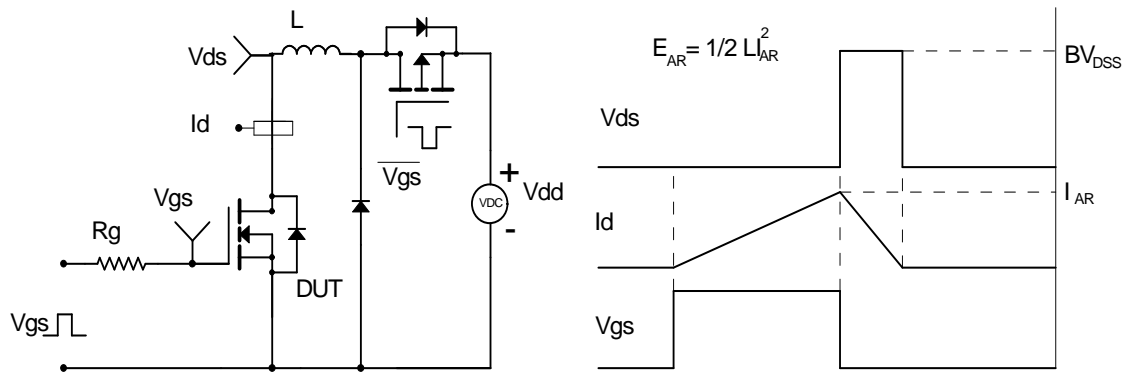

Diode Recovery Test Circuit & Waveforms

