

G3VM-21HR/31HR/31HR1/41HR

MOS FET Relays SOP 6-pin, High-current and Low-ON-resistance Type

MOS FET Relays in SOP 6-pin packages that achieve the low ON resistance and high switching capacitance of a mechanical relay

- Load voltage: 20 V, 30 V or 40 V
- 20-V Relay (21HR): Continuous load current of 2.5 A (5 A) max. *
- 30-V Relay (31HR): Continuous load current of 4 A (8 A) max. *
- 30-V Relay (31HR1): Continuous load current of 4.5 A (9 A) max. *
- 40-V Relay (41HR): Continuous load current of 2.5 A (5 A) max. *

* Values in parentheses are for connection C.

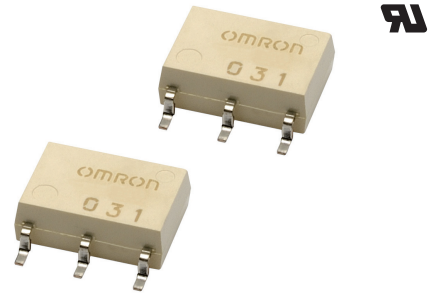

Note: The actual product is marked differently from the image shown here.

RoHS Compliant

Application Examples

- Semiconductor test equipment
- Security equipment
- Amusement equipment
- Communication equipment
- Industrial equipment
- Test & Measurement equipment
- Power circuit

Package

(Unit : mm, Average)

SOP 6-pin

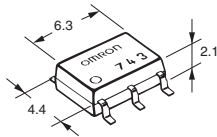

Note: The actual product is marked differently from the image shown here.

Model Number Legend

G3VM-□□□□□
1 2 3 4 5

- | | | |
|------------------------|--------------------------------|--|
| 1. Load Voltage | 2. Contact form | 3. Package |
| 2 : 20 V | 1 : 1a (SPST-NO) | H : SOP 6-pin |
| 3 : 30 V | | |
| 4 : 40 V | 4. Additional functions | 5. Other informations |
| | R: Low ON resistance | When specifications overlap, serial code is added in the recorded order. |

Ordering Information

Package	Contact form	Terminals	Load voltage (peak value) *	Continuous load current (peak value) *		Stick packaging		Tape packaging	
				Connection A, B	Connection C	Model	Minimum package quantity	Model	Minimum package quantity
SOP6	1a (SPST-NO)	Surface-mounting Terminals	20 V	2.5 A	5 A	G3VM-21HR	75	G3VM-21HR(TR)	2,500
			30 V	4 A	8 A	G3VM-31HR		G3VM-31HR(TR05)	500
			30 V	4.5 A	9 A	G3VM-31HR1		G3VM-31HR1(TR05)	
			40 V	2.5 A	5 A	G3VM-41HR		G3VM-41HR(TR)	2,500

* The AC peak and DC value are given for the load voltage and continuous load current.

Note: To order tape packaging for Relays with surface-mounting terminals, add "(TR)" or "(TR05)" to the end of the model number.

SOP 6-pin

Absolute Maximum Ratings (Ta = 25°C)

Item	Symbol	G3VM-21HR	G3VM-31HR	G3VM-31HR1	G3VM-41HR	Unit	Measurement conditions	
Input	LED forward current	IF	30			mA		
	LED forward current reduction rate	$\Delta I_F/^\circ\text{C}$	-0.3			mA/°C	Ta ≥ 25°C	
	LED reverse voltage	VR	5	6	5	V		
	Connection temperature	TJ	125			°C		
Output	Load voltage (AC peak/DC)	VOFF	20	30	40	V		
	Continuous load current	Connection A	Io	2500	4000	4500	mA	Connection A: AC peak/DC Connection B and C: DC
		Connection B		5000	8000	9000		
		Connection C		5000	5000			
	ON current reduction rate	Connection A	$\Delta I_o/^\circ\text{C}$	-33.3	-40	-45	mA/°C	G3VM-31HR/31HR1: Ta ≥ 25°C Others: Ta ≥ 50°C
		Connection B		-66.7	-80	-90		
		Connection C		-66.7	-66.7			
Pulse ON current	Iop	7.5	12	13.5	7.5	A	t=100 ms, Duty=1/10	
Connection temperature	TJ	125			°C			
Dielectric strength between I/O *	Vi-o	1500			Vrms	AC for 1 min		
Ambient operating temperature	Ta	-40 to +85		-40 to +110	-40 to +85	°C	With no icing or condensation	
Ambient storage temperature	Tstg	-55 to +125			°C			
Soldering temperature	-	260			°C	10 s		

* The dielectric strength between the input and output was checked by applying voltage between all pins as a group on the LED side and all pins as a group on the light-receiving side.

Connection Diagram

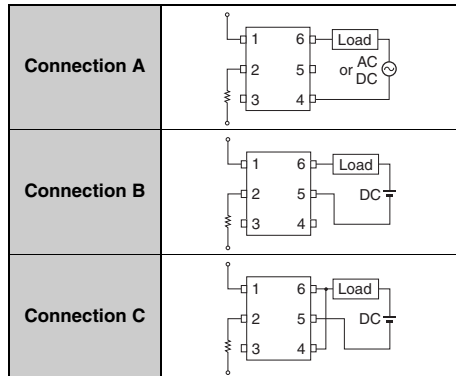

Electrical Characteristics (Ta = 25°C)

Item		Symbol	G3VM-21HR	G3VM-31HR	G3VM-31HR1	G3VM-41HR	Unit	Measurement conditions		
Input	LED forward voltage	VF	Minimum	1.18	1.50	1.18	V	If=10 mA		
		Typical	1.33	1.65	1.33					
		Maximum	1.48	1.80	1.48					
	Reverse current	IR	Maximum	10			μA	VR=5 V		
	Capacitance between terminals	CT	Typical	70			pF	V=0, f=1 MHz		
Output	Trigger LED forward current	IFT	Typical	-	0.3	0.4	mA	G3VM-31HR1 : Io=1000 mA Others : Io=100 mA		
		Maximum	3							
	Release LED forward current	IFC	Minimum	0.1			mA	IOFF=10 μA		
Output	Maximum resistance with output ON	RON	Typical	0.02	0.02	0.022	0.03	Ω	G3VM-31HR: If=5 mA Io=4 A (Connection A, B) Io=8 A (C connections), t<1s G3VM-31HR1: If=5 mA Io=4.5 A (Connection A, B) Io=9 A (C connections), t<1s Others: If=5 mA Io=2 A (Connection A, B) Io=4 A (C connections), t<1s	
				0.01	0.008	0.011	0.015			
				0.005	0.004	0.006	0.008			
				Maximum	0.05	0.04	0.03			0.06
					0.025	0.02	0.015			0.03
					-	0.01	0.008			-
Current leakage when the relay is open	ILEAK	Typical	-			nA	VOFF= Load voltage ratings			
		Maximum	10	1000	10					
Capacitance between terminals	COFF	Typical	1000	1100	1200	1000	pF	V=0, f=1 MHz		
		Maximum	-							
Capacitance between I/O terminals	CI-O	Typical	0.8			pF	f=1 MHz, VS=0 V			
Insulation resistance between I/O terminals	RI-O	Minimum	1000			MΩ	VI-O=500 VDC, RoH≤60%			
		Typical	10 ⁸							
Turn-ON time	TON	Typical	1.5	1.1	0.6	1.0	ms	G3VM-21HR : If=5 mA, RL=200 Ω, VDD=10 V * Others : If=5 mA, RL=200 Ω, VDD=20 V *		
Maximum		5			2	5				
Turn-OFF time	TOFF	Typical	0.1		0.15		ms			
		Maximum	1	0.5	1					

* Turn-ON and Turn-OFF Times

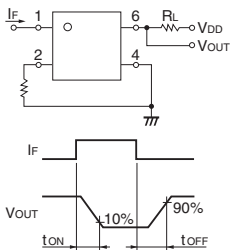

Recommended Operating Conditions

For usage with high reliability, Recommended Operation Conditions is a measure that takes into account the derating of Absolute Maximum Ratings and Electrical Characteristics.

Each item on this list is an independent condition, so it is not simultaneously satisfy several conditions.

Item	Symbol		G3VM-21HR	G3VM-31HR	G3VM-31HR1	G3VM-41HR	Unit
Load voltage (AC peak/DC)	VDD	Maximum	20	24		40	V
Operating LED forward current	IF	Minimum	5			mA	
		Typical	10				
		Maximum	20	25	20		
Continuous load current (AC peak/DC)	Io	Maximum	2000	4000	4500	2000	
Ambient operating temperature	Ta	Minimum	-20			°C	
		Maximum	65	85	65		

Spacing and Insulation

Item	Minimum	Unit
Creepage distances	4.0	mm
Clearance distances	4.0	
Internal isolation thickness	0.1	

Engineering Data

LED forward current vs. Ambient temperature

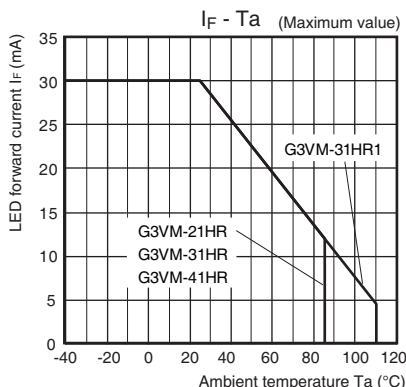

Continuous load current vs. Ambient temperature

G3VM-21HR/41HR

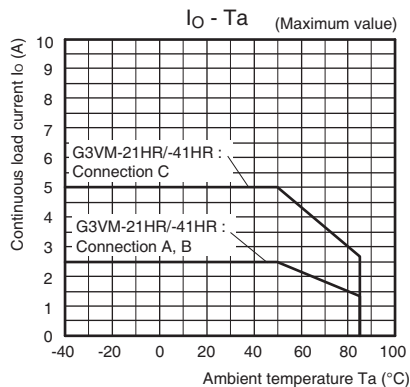

G3VM-31HR/31HR1

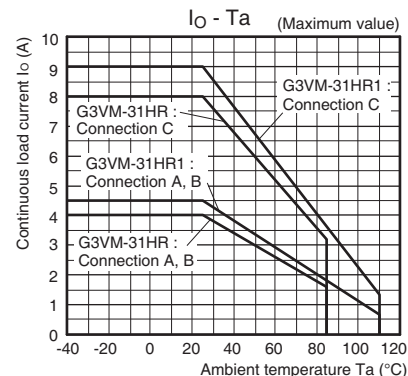

LED forward current vs. LED forward voltage

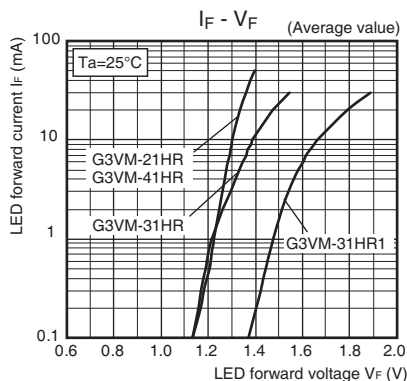

Continuous load current vs. On-state voltage

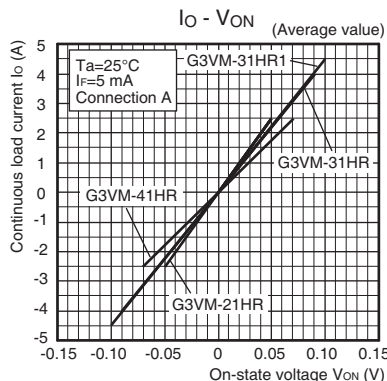

On-state resistance vs. Ambient temperature

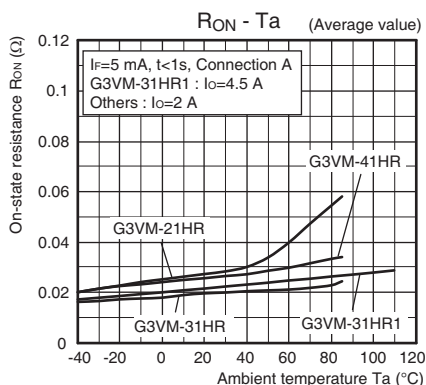

Trigger LED forward current vs. Ambient temperature

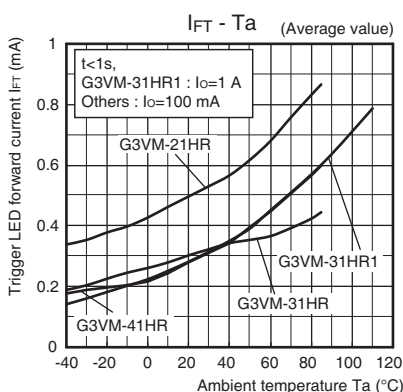

Turn ON, Turn OFF time vs. LED forward current

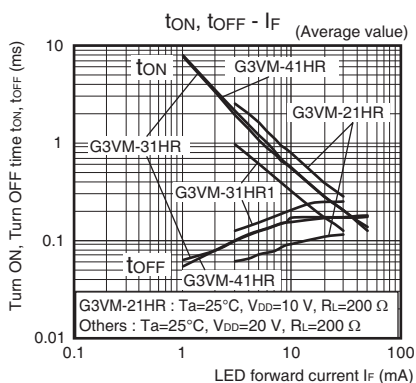

Turn ON, Turn OFF time vs. Ambient temperature

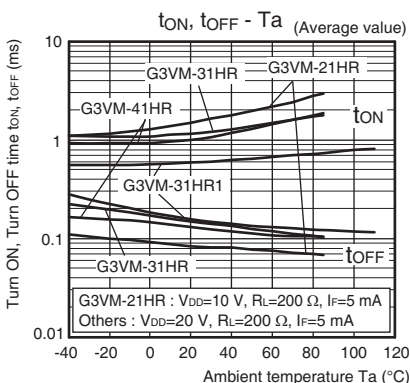

SOP

G3VM-21HR/31HR/31HR1/41HR

Engineering Data

Current leakage vs. Load voltage

G3VM-21HR/41HR

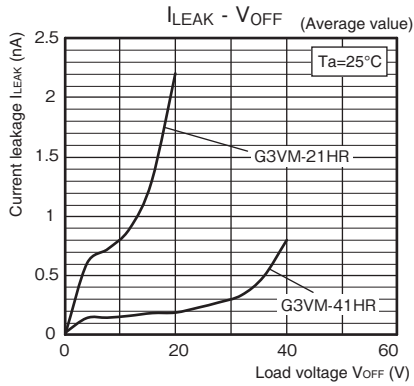

G3VM-31HR1

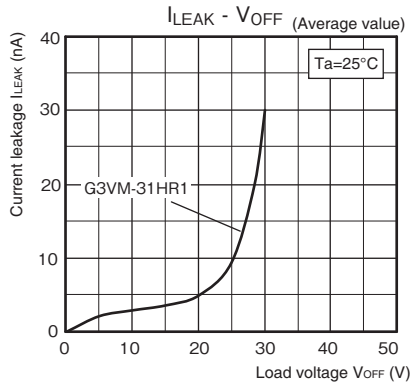

Current leakage vs. Ambient temperature G3VM-31HR/31HR1

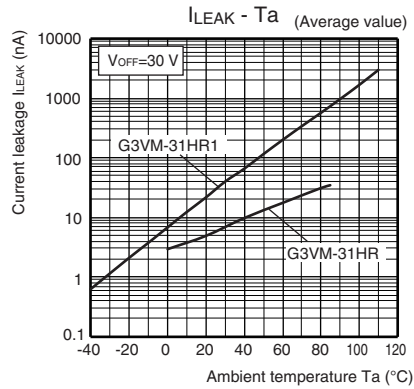

Output terminal capacitance vs. Load voltage G3VM-21HR/31HR1/41HR

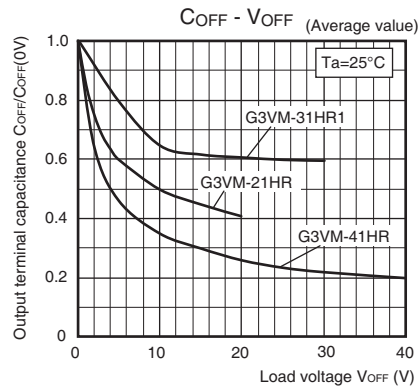

Appearance / Terminal Arrangement / Internal Connections

Appearance

SOP (Small Outline Package)

SOP 6-pin

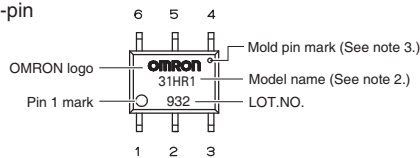

- Note: 1.** The actual product is marked differently from the image shown here.
- Note: 2.** "G3VM" does not appear in the model number on the Relay.
- Note: 3.** The indentation in the corner diagonally opposite from the pin 1 mark is from a pin on the mold.

Terminal Arrangement/Internal Connections (Top View)

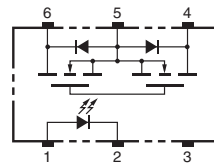

Dimensions (Unit: mm)

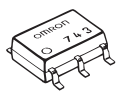

Surface-mounting Terminals

Weight: 0.13 g

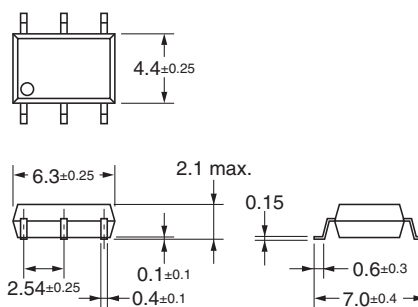

Actual Mounting Pad Dimensions

(Recommended Value, Top View)

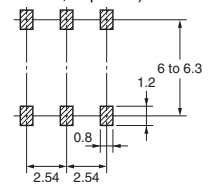

Note: The actual product is marked differently from the image shown here.

Approved Standards

UL recognized

Approved Standards	Contact form	File No.
UL (recognized)	1a (SPST-NO)	E80555

Safety Precautions

- Refer to the *Common Precautions for All MOS FET Relays* for precautions that apply to all MOS FET Relays.

SOP
G3VM-21HR/31HR/31HR1/41HR

Please check each region's Terms & Conditions by region website.

OMRON Corporation Electronic and Mechanical Components Company

Regional Contact

Americas

<https://www.components.omron.com/>

Asia-Pacific

<https://ecb.omron.com.sg/>

Korea

<https://www.omron-ecb.co.kr/>

Europe

<http://components.omron.eu/>

China

<https://www.ecb.omron.com.cn/>

Japan

<https://www.omron.co.jp/ecb/>