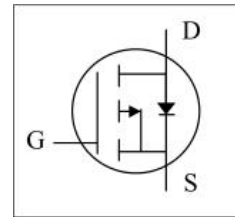

General Description

The AO4405 uses advanced trench technology to provide excellent $R_{DS(ON)}$ with low gate charge. This device is suitable for use as a load switch or in PWM applications.

General Features

$V_{DS} = -30V$ $I_D = -6 A$

$R_{DS(ON)} < 45m\Omega$ @ $V_{GS}=10V$

Application

Battery protection

Load switch

Uninterruptible power supply

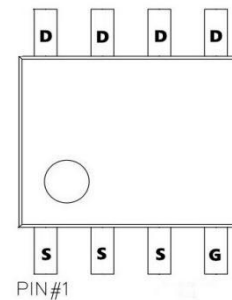
Absolute Maximum Ratings $T_A=25^\circ C$ unless otherwise noted

Parameter	Symbol	Maximum	Units
Drain-Source Voltage	V_{DS}	-30	V
Gate-Source Voltage	V_{GS}	± 20	V
Continuous Drain Current	I_D	$T_A=25^\circ C$	-6
		$T_A=70^\circ C$	-5.1
Pulsed Drain Current ^C	I_{DM}	-30	A
Avalanche Current ^C	I_{AS}, I_{AR}	17	A
Avalanche energy $L=0.1mH$ ^C	E_{AS}, E_{AR}	14	mJ
V_{DS} Spike	V_{SPIKE}	-36	V
Power Dissipation ^B	P_D	$T_A=25^\circ C$	3.1
		$T_A=70^\circ C$	2
Junction and Storage Temperature Range	T_J, T_{STG}	-55 to 150	$^\circ C$

Thermal Characteristics

Parameter	Symbol	Typ	Max	Units
Maximum Junction-to-Ambient ^A	$R_{\theta JA}$	31	40	$^\circ C/W$
Maximum Junction-to-Ambient ^{A,D}		Steady-State	59	75
Maximum Junction-to-Lead	$R_{\theta JL}$	16	24	$^\circ C/W$

Electrical Characteristics (25°C unless otherwise noted)

Symbol	Parameter	Conditions	Min	Typ	Max	Units
BV_{DSS}	Drain-Source Breakdown Voltage	$I_D = -250\mu A, V_{GS} = 0V$	-30			V
I_{DSS}	Zero Gate Voltage Drain Current	$V_{DS} = -30V, V_{GS} = 0V$ $T_J = 55^\circ C$			-1	μA
					-5	
I_{GSS}	Gate-Body leakage current	$V_{DS} = 0V, V_{GS} = \pm 20V$			± 100	nA
$V_{GS(th)}$	Gate Threshold Voltage	$V_{DS} = V_{GS}, I_D = -250\mu A$	-1	-1.5	-2.5	V
$I_{D(ON)}$	On state drain current	$V_{GS} = -10V, V_{DS} = -5V$	-30			A
$R_{DS(ON)}$	Static Drain-Source On-Resistance	$V_{GS} = -10V, I_D = -6A$		33	45	$m\Omega$
		$V_{GS} = -4.5V, I_D = -5A$		53	75	$m\Omega$
g_{FS}	Forward Transconductance	$V_{DS} = -5V, I_D = -6A$		14		S
V_{SD}	Diode Forward Voltage	$I_S = -1A, V_{GS} = 0V$		-0.8	-1	V
I_S	Maximum Body-Diode Continuous Current				-3.5	A
C_{iss}	Input Capacitance			520		pF
C_{oss}	Output Capacitance	$V_{GS} = 0V, V_{DS} = -15V, f = 1MHz$		100		pF
C_{rss}	Reverse Transfer Capacitance			65		pF
R_g	Gate resistance	$V_{GS} = 0V, V_{DS} = 0V, f = 1MHz$	3.5	7.5	11.5	Ω
$Q_g(10V)$	Total Gate Charge	$V_{GS} = -10V, V_{DS} = -15V, I_D = -6A$		9.2	11	nC
$Q_g(4.5V)$	Total Gate Charge			4.6	6	nC
Q_{gs}	Gate Source Charge			1.6		nC
Q_{gd}	Gate Drain Charge			2.2		nC
$t_{D(on)}$	Turn-On Delay Time				7.5	
t_r	Turn-On Rise Time	$V_{GS} = -10V, V_{DS} = -15V, R_L = 2.5\Omega,$ $R_{GEN} = 3\Omega$		5.5		ns
$t_{D(off)}$	Turn-Off Delay Time			19		ns
t_f	Turn-Off Fall Time			7		ns
t_{rr}	Body Diode Reverse Recovery Time	$I_F = -6A, dI/dt = 100A/\mu s$		11		ns
Q_{rr}	Body Diode Reverse Recovery Charge	$I_F = -6A, dI/dt = 100A/\mu s$		5.3		nC

- A. The value of $R_{\theta JA}$ is measured with the device mounted on 1in² FR-4 board with 2oz. Copper, in a still air environment with $T_A = 25^\circ C$. The value in any given application depends on the user's specific board design.
- B. The power dissipation P_D is based on $T_{J(MAX)} = 150^\circ C$, using $\leq 10s$ junction-to-ambient thermal resistance.
- C. Repetitive rating, pulse width limited by junction temperature $T_{J(MAX)} = 150^\circ C$. Ratings are based on low frequency and duty cycles to keep initial $T_J = 25^\circ C$.
- D. The $R_{\theta JA}$ is the sum of the thermal impedance from junction to lead $R_{\theta JL}$ and lead to ambient.
- E. The static characteristics in Figures 1 to 6 are obtained using $< 300\mu s$ pulses, duty cycle 0.5% max.
- F. These curves are based on the junction-to-ambient thermal impedance which is measured with the device mounted on 1in² FR-4 board with 2oz. Copper, assuming a maximum junction temperature of $T_{J(MAX)} = 150^\circ C$. The SOA curve provides a single pulse rating.

Typical characteristic

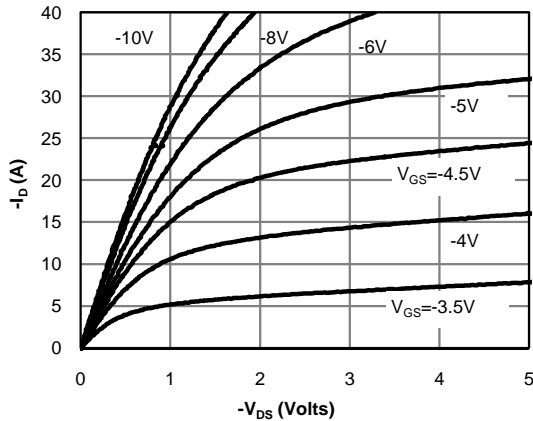

Fig 1: On-Region Characteristics (Note E)

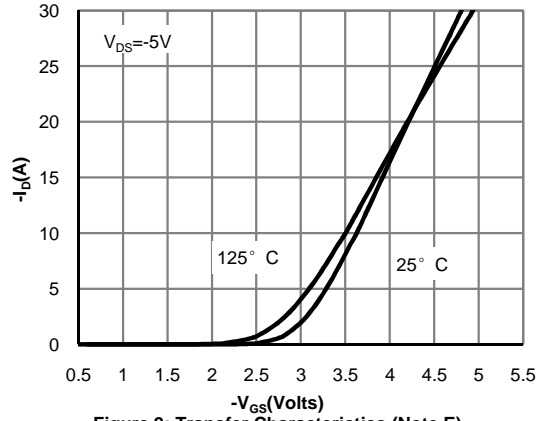

Figure 2: Transfer Characteristics (Note E)

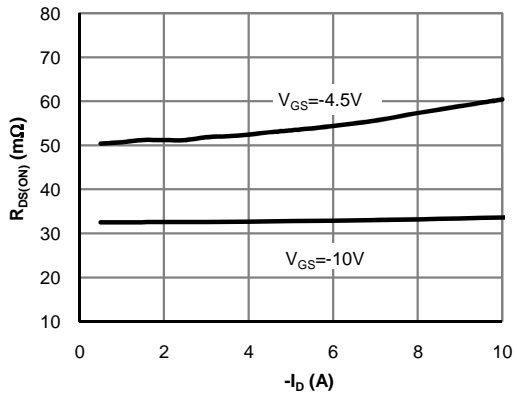

Figure 3: On-Resistance vs. Drain Current and Gate Voltage (Note E)

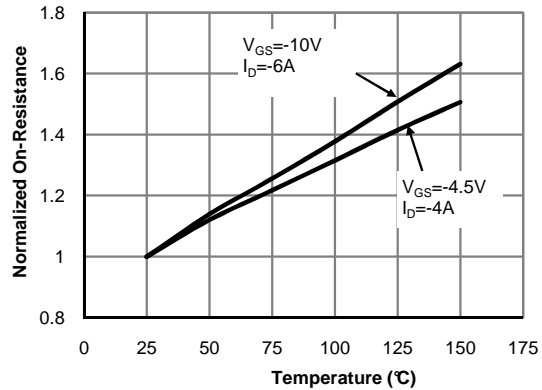

Figure 4: On-Resistance vs. Junction Temperature (Note E)

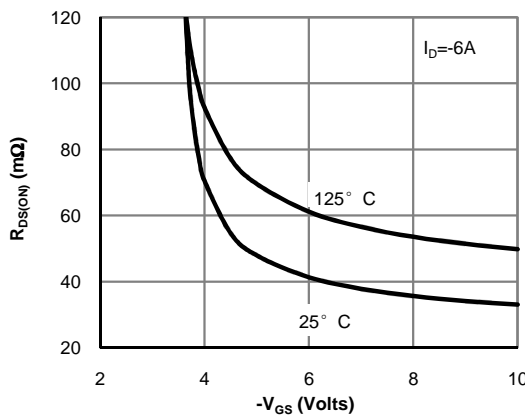

Figure 5: On-Resistance vs. Gate-Source Voltage (Note E)

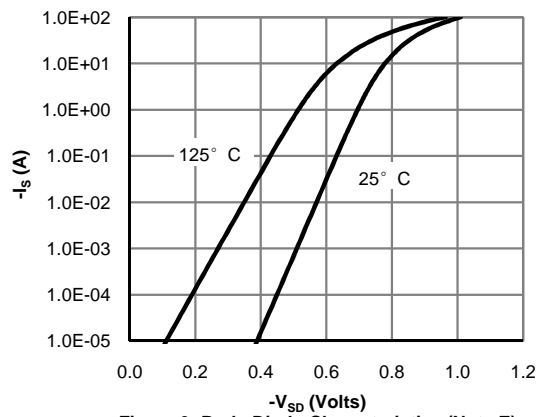

Figure 6: Body-Diode Characteristics (Note E)

Typical characteristic

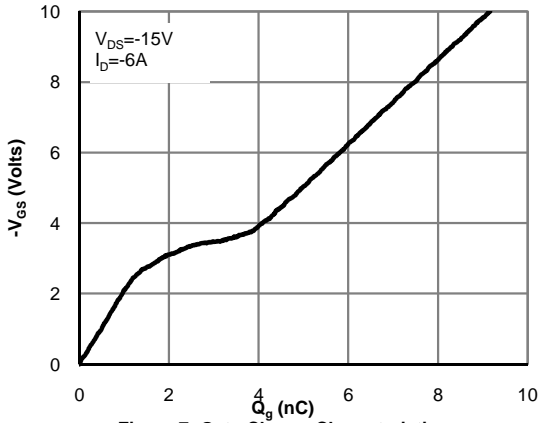

Figure 7: Gate-Charge Characteristics

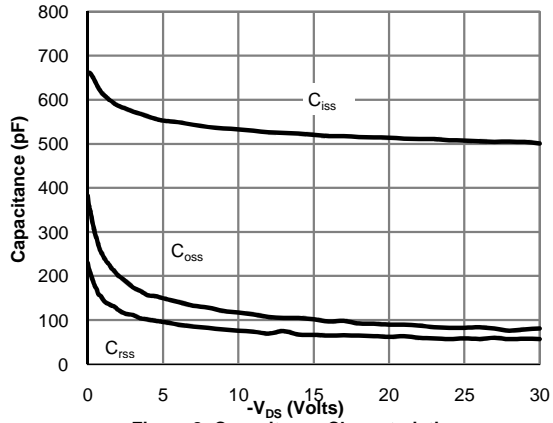

Figure 8: Capacitance Characteristics

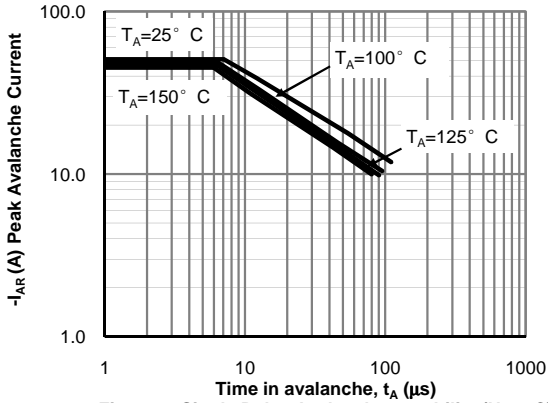

Figure 9: Single Pulse Avalanche capability (Note C)

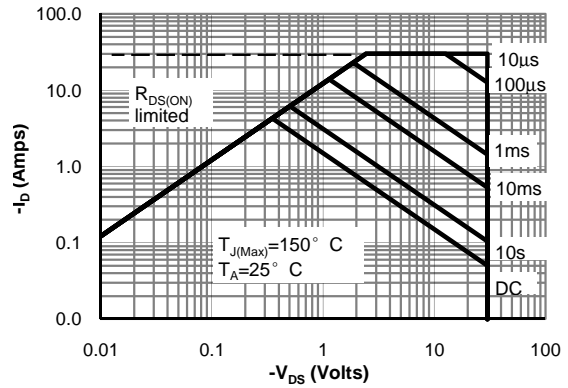

Figure 10: Maximum Forward Biased Safe Operating Area (Note F)

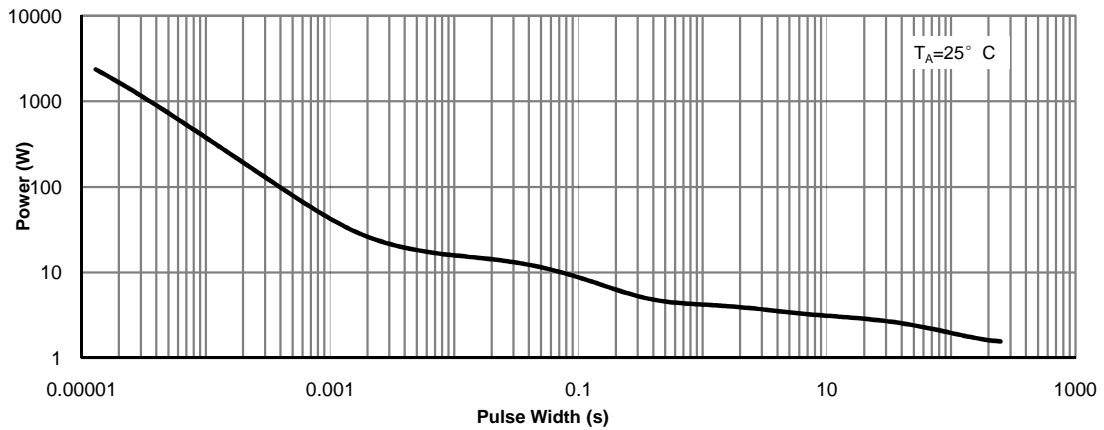

Figure 11: Single Pulse Power Rating Junction-to-Ambient (Note F)

Typical characteristic

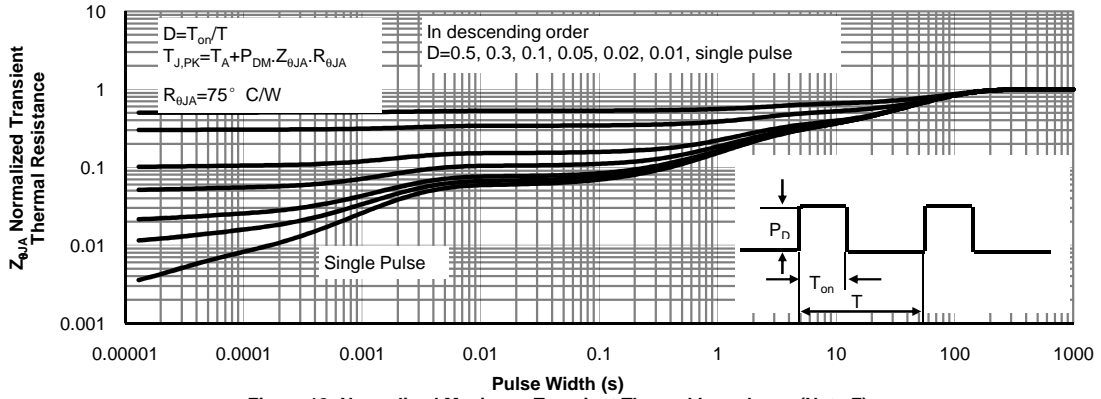
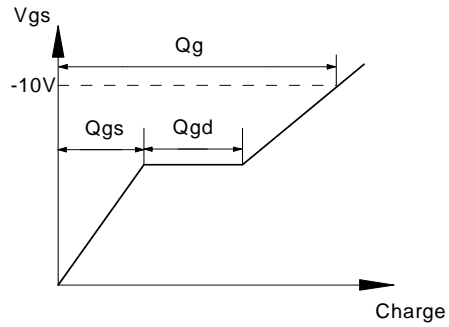
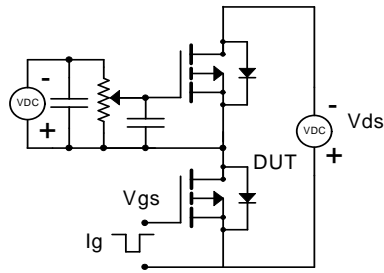
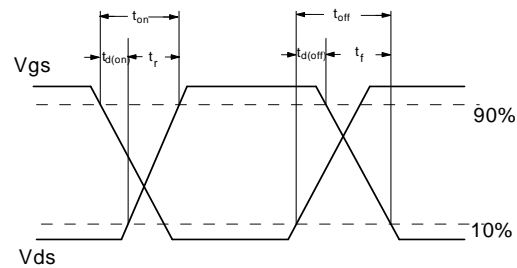
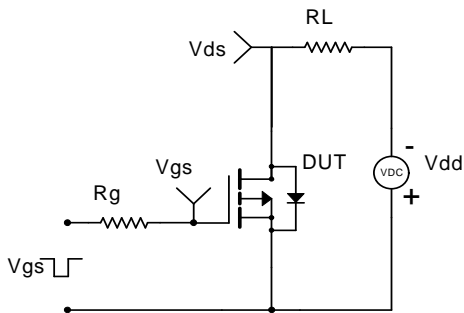

Figure 12: Normalized Maximum Transient Thermal Impedance (Note F)

Gate Charge Test Circuit & Waveform



Resistive Switching Test Circuit & Waveforms



Unclamped Inductive Switching (UIS) Test Circuit & Waveforms

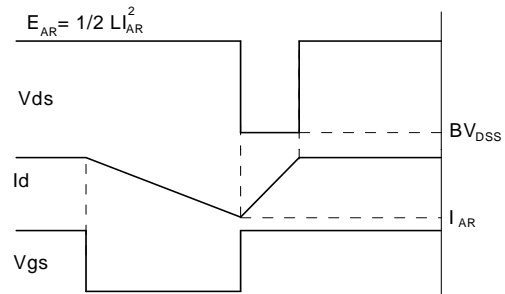
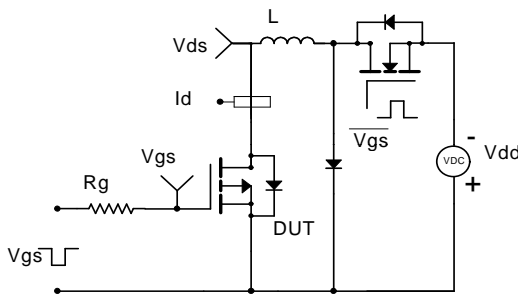

Diode Recovery Test Circuit & Waveforms

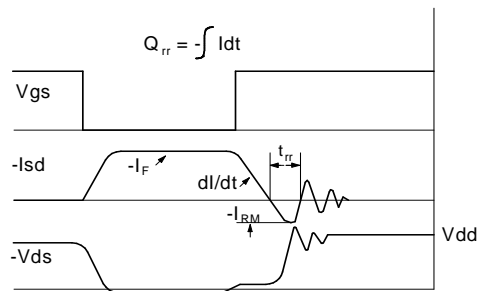
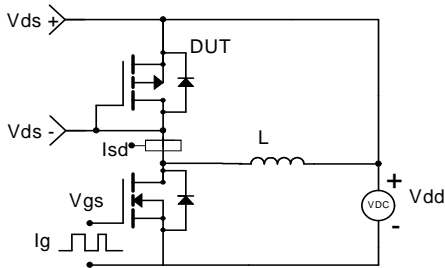

PACKAGE OUTLINE DIMENSIONS

SOP-8

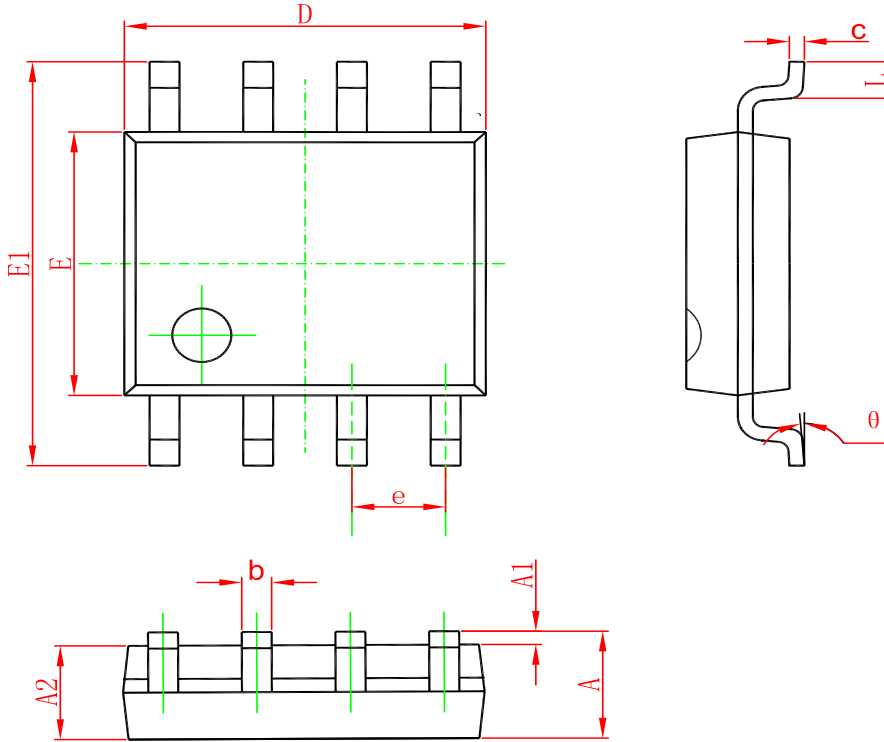

Symbol	Dimensions In Millimeters		Dimensions In Inches	
	Min	Max	Min	Max
A	1.350	1.750	0.053	0.069
A1	0.100	0.250	0.004	0.010
A2	1.350	1.550	0.053	0.061
b	0.330	0.510	0.013	0.020
c	0.170	0.250	0.006	0.010
D	4.700	5.100	0.185	0.200
E	3.800	4.000	0.150	0.157
E1	5.800	6.200	0.228	0.244
e	1.270(BSC)		0.050(BSC)	
L	0.400	1.270	0.016	0.050
θ	0°	8°	0°	8°

Marking

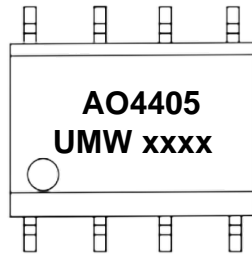

("xxxx"代表年份周期)

Ordering information

Order code	Package	Baseqty	Deliverymode
UMW AO4405	SOP-8	3000	Tape and reel