

GenX3™ 600V IGBT
IXGH56N60A3

$$V_{CES} = 600V$$

$$I_{C110} = 56A$$

$$V_{CE(sat)} \leq 1.35V$$

Ultra-Low V_{sat} PT IGBT for up to 5 kHz Switching

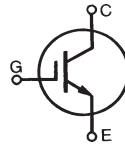

Symbol	Test Conditions	Maximum Ratings	
V_{CES}	$T_C = 25^\circ C$ to $150^\circ C$	600	V
V_{CGR}	$T_J = 25^\circ C$ to $150^\circ C$, $R_{GE} = 1M\Omega$	600	V
V_{GES}	Continuous	± 20	V
V_{GEM}	Transient	± 30	V
I_{C25}	$T_C = 25^\circ C$ (Chip Capability)	150	A
I_{C110}	$T_C = 110^\circ C$	56	A
I_{CM}	$T_C = 25^\circ C$, 1ms	370	A
SSOA (RBSOA)	$V_{GE} = 15V$, $T_{VJ} = 125^\circ C$, $R_G = 5\Omega$ Clamped Inductive Load	$I_{CM} = 150$ $V_{CE} \leq 0.8 \cdot V_{CES}$	A
P_d	$T_C = 25^\circ C$	330	W
T_J		- 55 ... +150	$^\circ C$
T_{JM}		150	$^\circ C$
T_{stg}		- 40 ... +150	$^\circ C$
T_L	1.6mm (0.062 in.) from Case for 10s	300	$^\circ C$
T_{SOLD}	Plastic Body for 10 seconds	260	$^\circ C$
M_d	Mounting torque	1.13/10	Nm/lb.in.
Weight		6	g

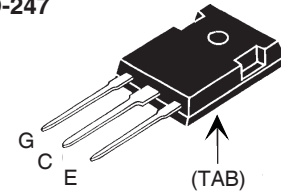
TO-247

G = Gate C = Collector
E = Emitter TAB = Collector

Features

- Optimized for Low Conduction Losses
- International Standard Package

Advantages

- High Power Density
- Low Gate Drive Requirement

Applications

- Power Inverters
- UPS
- Motor Drives
- SMPS
- PFC Circuits
- Battery Chargers
- Welding Machines
- Lamp Ballasts
- Inrush Current Protection Circuits

Symbol	Test Conditions ($T_J = 25^\circ C$, Unless Otherwise Specified)	Characteristic Values		
		Min.	Typ.	Max.
BV_{CES}	$I_C = 250\mu A$, $V_{CE} = 0V$	600		V
$V_{GE(th)}$	$I_C = 250\mu A$, $V_{CE} = V_{GE}$	3.0		5.0 V
I_{CES}	$V_{CE} = V_{CES}$, $V_{GE} = 0V$ $T_J = 125^\circ C$			50 μA 500 μA
I_{GES}	$V_{CE} = 0V$, $V_{GE} = \pm 20V$			± 100 nA
$V_{CE(sat)}$	$I_C = 44A$, $V_{GE} = 15V$, Note 1 $T_J = 125^\circ C$		1.22 1.22	1.35 V V

Symbol Test Conditions

($T_J = 25^\circ\text{C}$ unless otherwise specified)

Characteristic Values

Symbol	Test Conditions	Characteristic Values		
		Min.	Typ.	Max.
g_{fs}	$I_C = 44\text{A}, V_{CE} = 10\text{V}$, Note 1	33	55	S
C_{ies}	$V_{CE} = 25\text{V}, V_{GE} = 0\text{V}, f = 1\text{MHz}$		3950	pF
C_{oes}			220	pF
C_{res}			56	pF
Q_g	$I_C = 44\text{A}, V_{GE} = 15\text{V}, V_{CE} = 0.5 \cdot V_{CES}$		140	nC
Q_{ge}			26	nC
Q_{gc}			52	nC
$t_{d(on)}$	Inductive load, $T_J = 25^\circ\text{C}$ $I_C = 44\text{A}, V_{GE} = 15\text{V}$ $V_{CE} = 480\text{V}, R_G = 5\Omega$ Note 2		26	ns
t_{ri}			42	ns
E_{on}			1.00	mJ
$t_{d(off)}$			310	ns
t_{fi}			315	550 ns
E_{off}			3.75	6.50 mJ
$t_{d(on)}$	Inductive load, $T_J = 125^\circ\text{C}$ $I_C = 44\text{A}, V_{GE} = 15\text{V}$ $V_{CE} = 480\text{V}, R_G = 5\Omega$ Note 2		24	ns
t_{ri}			42	ns
E_{on}			2.00	mJ
$t_{d(off)}$			495	ns
t_{fi}			415	ns
E_{off}			6.75	mJ
R_{thJC}			0.375	$^\circ\text{C}/\text{W}$
R_{thCS}		0.21		$^\circ\text{C}/\text{W}$

TO-247 (IXGH) Outline

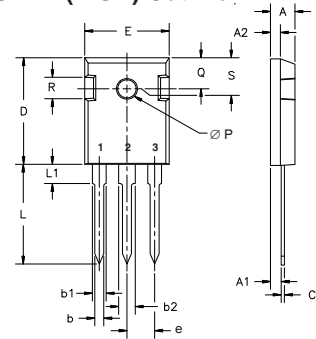

Terminals: 1 - Gate 2 - Drain
3 - Source Tab - Drain

Dim.	Millimeter		Inches	
	Min.	Max.	Min.	Max.
A	4.7	5.3	.185	.209
A ₁	2.2	2.54	.087	.102
A ₂	2.2	2.6	.059	.098
b	1.0	1.4	.040	.055
b ₁	1.65	2.13	.065	.084
b ₂	2.87	3.12	.113	.123
C	.4	.8	.016	.031
D	20.80	21.46	.819	.845
E	15.75	16.26	.610	.640
e	5.20	5.72	0.205	0.225
L	19.81	20.32	.780	.800
L1		4.50		.177
ØP	3.55	3.65	.140	.144
Q	5.89	6.40	0.232	0.252
R	4.32	5.49	.170	.216
S	6.15	BSC	242	BSC

Notes:

1. Pulse test, $t \leq 300\mu\text{s}$, duty cycle, $d \leq 2\%$.
2. Switching times & energy losses may increase for higher V_{CE} (clamp), T_J or R_G .

ADVANCE TECHNICAL INFORMATION

The product presented herein is under development. The Technical Specifications offered are derived from a subjective evaluation of the design, based upon prior knowledge and experience, and constitute a "considered reflection" of the anticipated result. IXYS reserves the right to change limits, test conditions, and dimensions without notice.

IXYS Reserves the Right to Change Limits, Test Conditions and Dimensions.

IXYS MOSFETs and IGBTs are covered by one or more of the following U.S. patents:	4,835,592	4,931,844	5,049,961	5,237,481	6,162,665	6,404,065 B1	6,683,344	6,727,585	7,005,734 B2	7,157,338B2
	4,850,072	5,017,508	5,063,307	5,381,025	6,259,123 B1	6,534,343	6,710,405 B2	6,759,692	7,063,975 B2	
	4,881,106	5,034,796	5,187,117	5,486,715	6,306,728 B1	6,583,505	6,710,463	6,771,478 B2	7,071,537	

Fig. 1. Output Characteristics
@ $T_J = 25^\circ\text{C}$

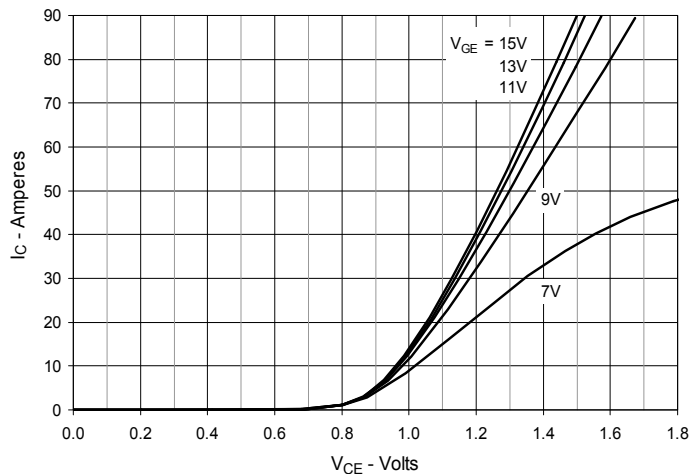

Fig. 2. Extended Output Characteristics
@ $T_J = 25^\circ\text{C}$

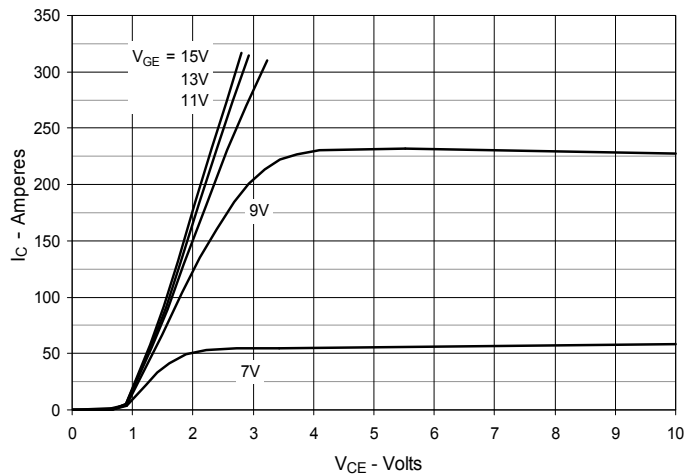

Fig. 3. Output Characteristics
@ $T_J = 125^\circ\text{C}$

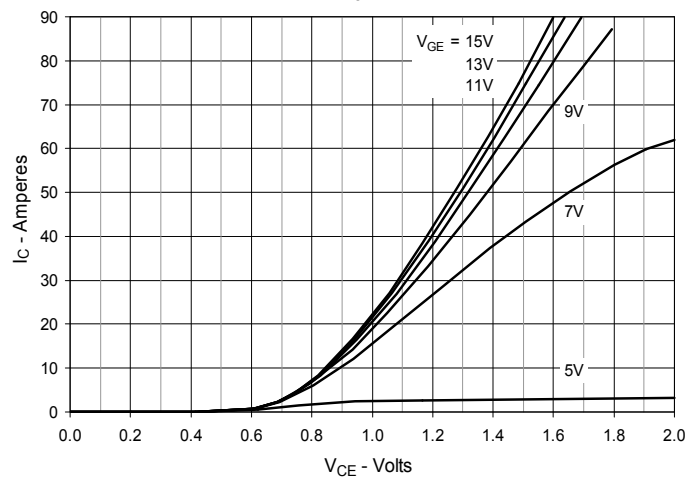

Fig. 4. Dependence of $V_{CE(sat)}$ on Junction Temperature

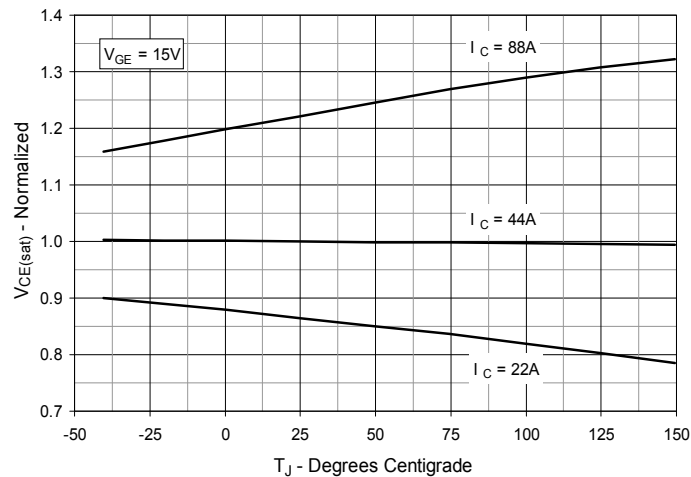

Fig. 5. Collector-to-Emitter Voltage vs. Gate-to-Emitter Voltage

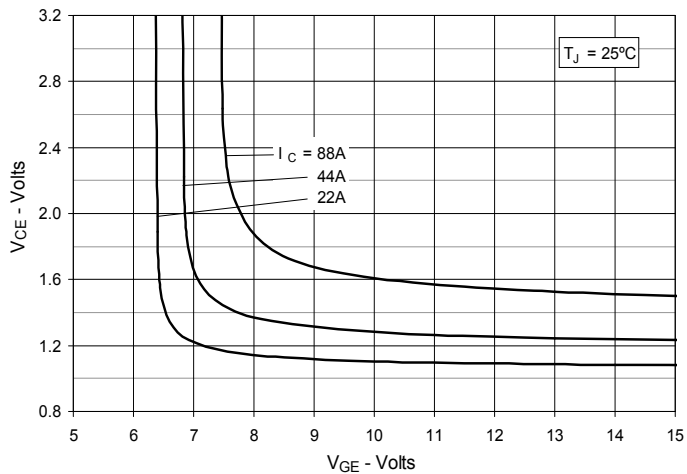

Fig. 6. Input Admittance

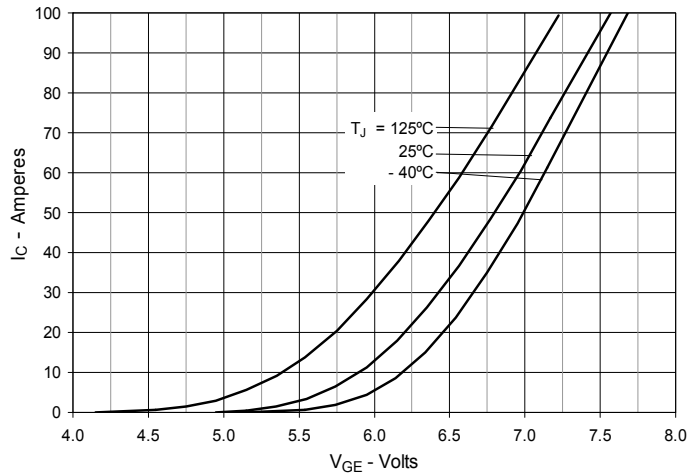

Fig. 7. Transconductance

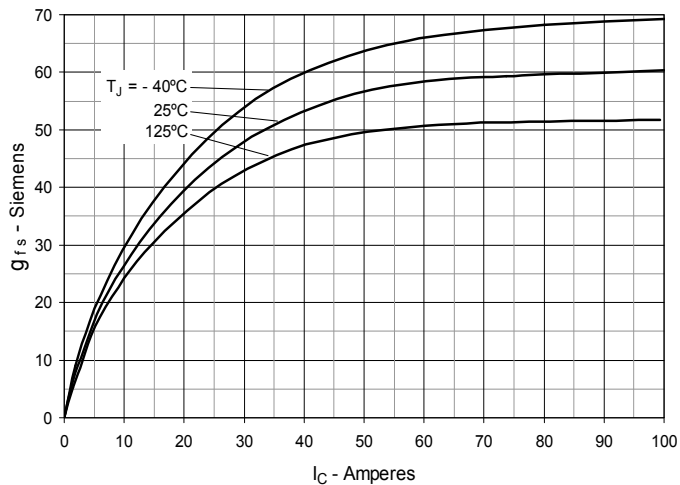

Fig. 8. Gate Charge

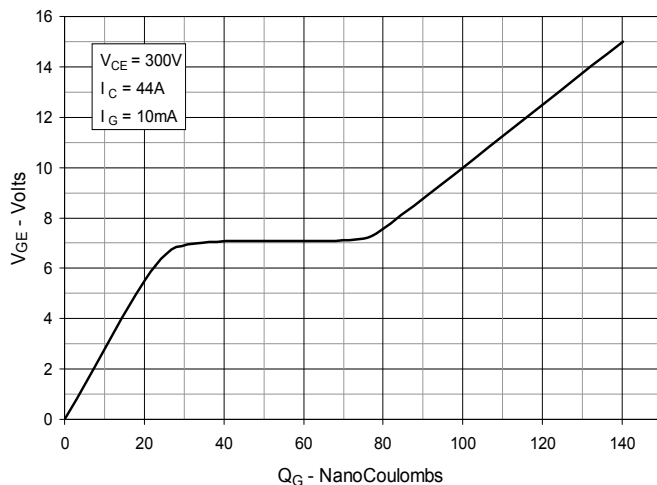

Fig. 9. Capacitance

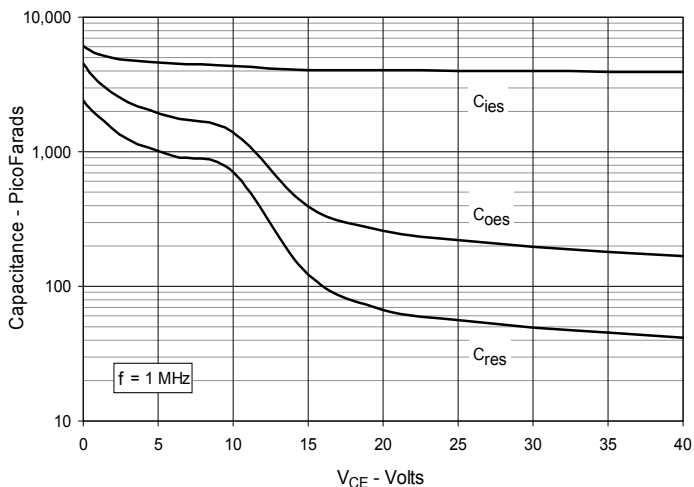

Fig. 10. Reverse-Bias Safe Operating Area

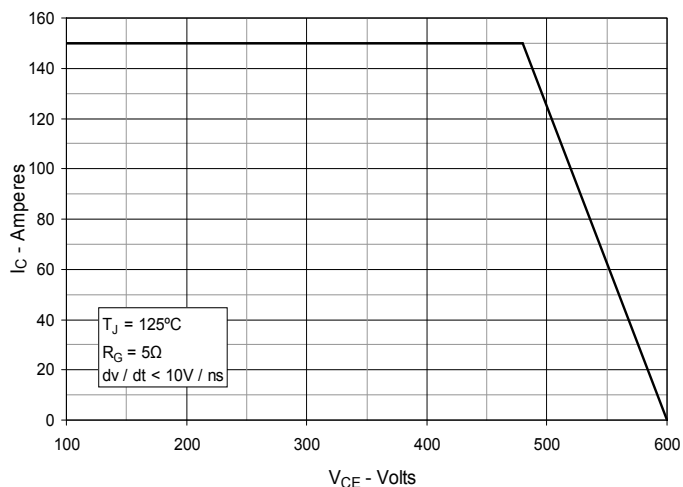
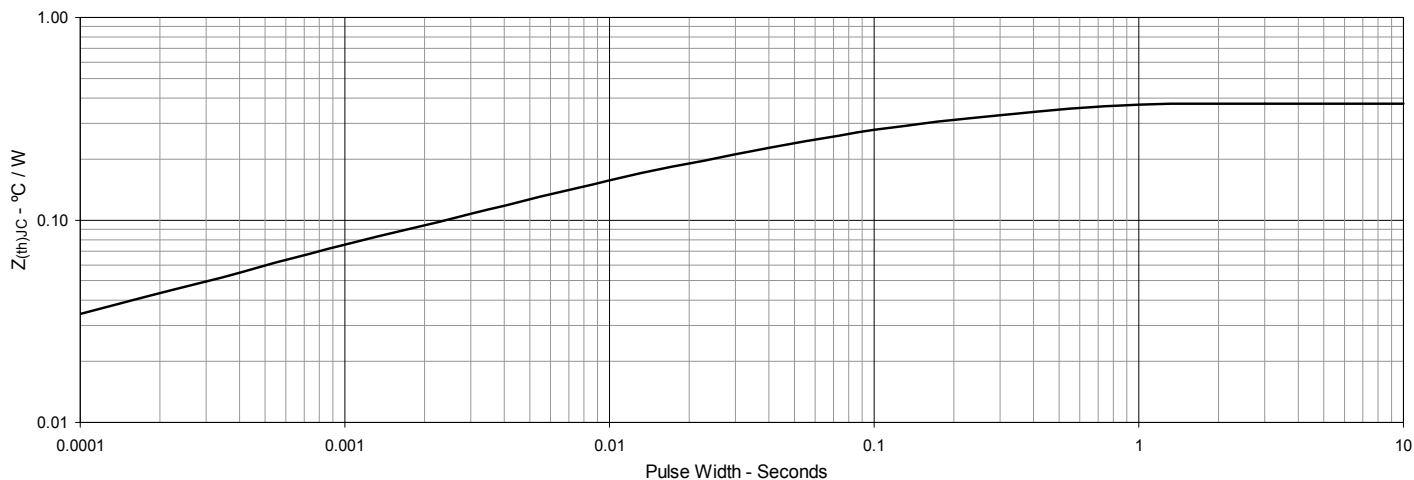
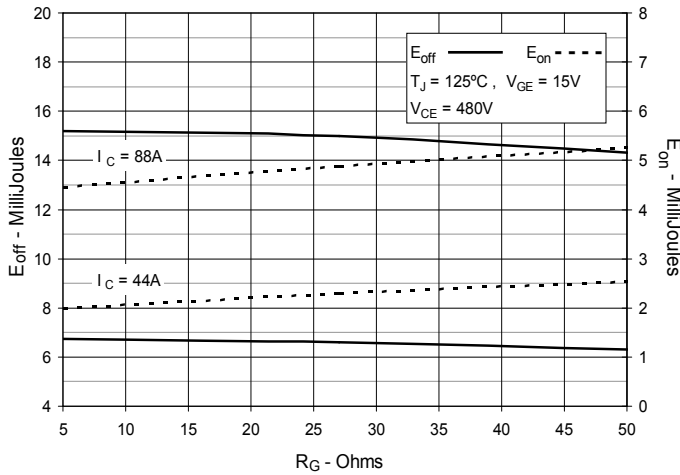
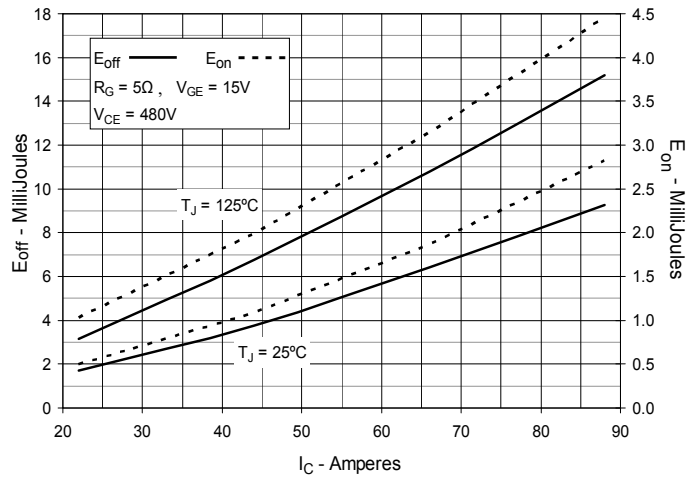
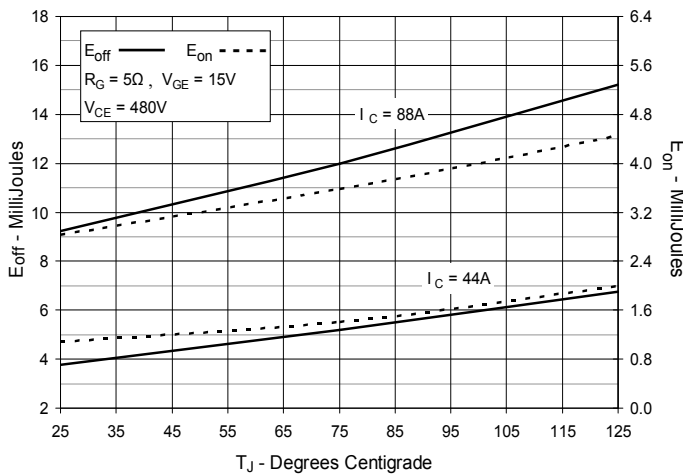
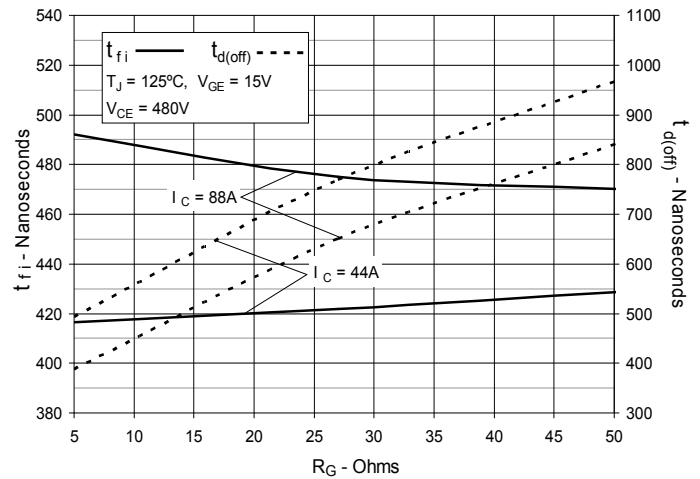
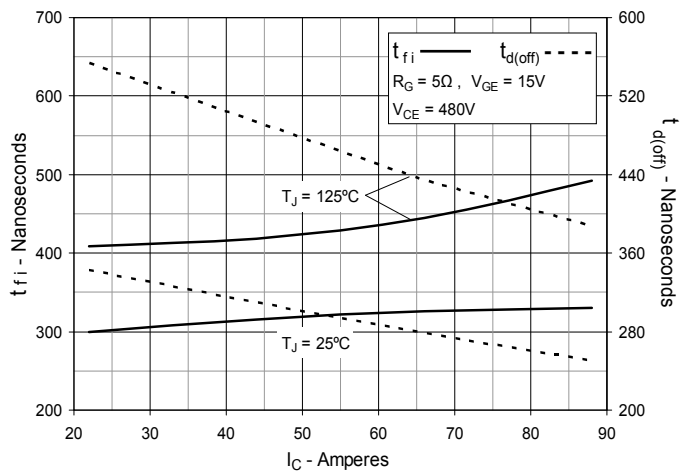
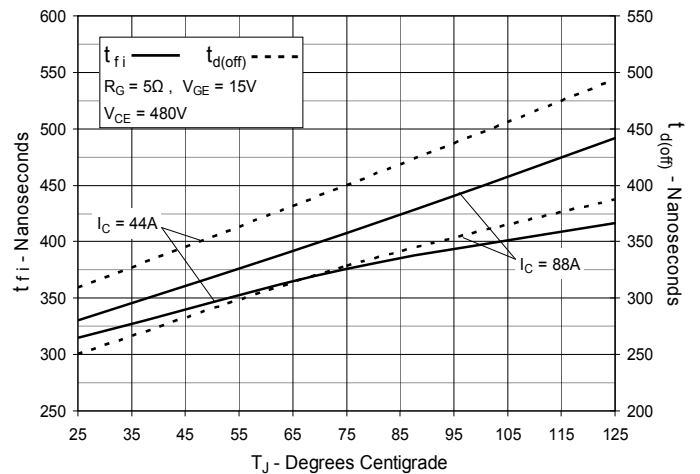

Fig. 11. Maximum Transient Thermal Impedance



IXYS Reserves the Right to Change Limits, Test Conditions and Dimensions.

**Fig. 12. Inductive Switching
Energy Loss vs. Gate Resistance**

**Fig. 13. Inductive Switching
Energy Loss vs. Collector Current**

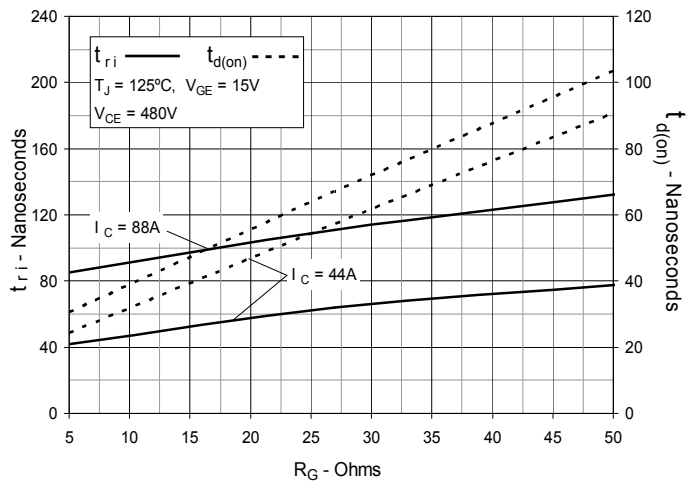
**Fig. 14. Inductive Switching
Energy Loss vs. Junction Temperature**

**Fig. 15. Inductive Turn-off
Switching Times vs. Gate Resistance**

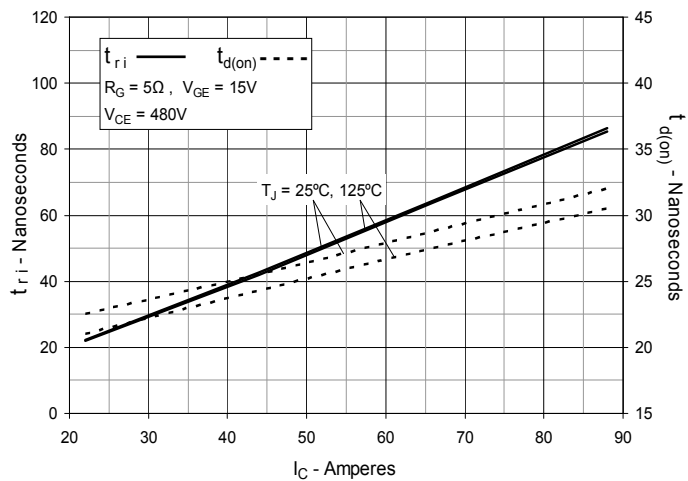
**Fig. 16. Inductive Turn-off
Switching Times vs. Collector Current**

**Fig. 17. Inductive Turn-off
Switching Times vs. Junction Temperature**

**Fig. 18. Inductive Turn-on
Switching Times vs. Gate Resistance**



**Fig. 19. Inductive Turn-on
Switching Times vs. Collector Current**



**Fig. 20. Inductive Turn-on
Switching Times vs. Junction Temperature**

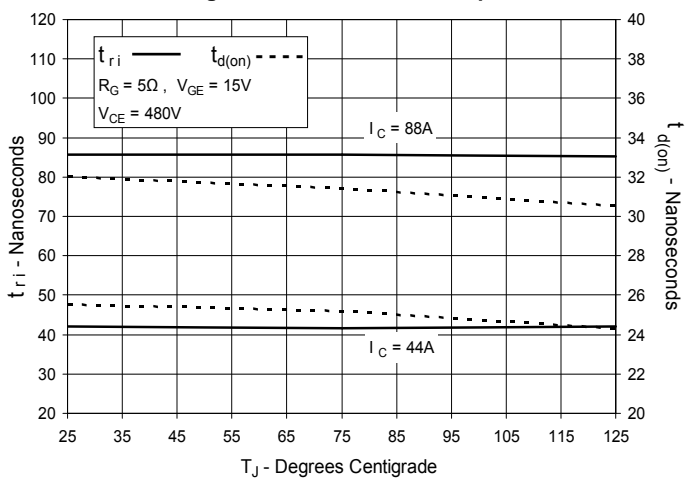



Disclaimer Notice - Information furnished is believed to be accurate and reliable. However, users should independently evaluate the suitability of and test each product selected for their own applications. Littelfuse products are not designed for, and may not be used in, all applications. Read complete Disclaimer Notice at www.littelfuse.com/disclaimer-electronics.