

# IRF5810

HEXFET® Power MOSFET

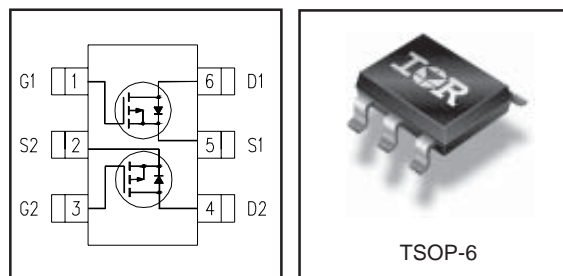
- Ultra Low On-Resistance
- Dual P-Channel MOSFET
- Surface Mount
- Available in Tape & Reel
- Low Gate Charge

$V_{DSS}$	$R_{DS(on)}$ max (m $\Omega$ )	$I_D$
<b>-20V</b>	90@ $V_{GS} = -4.5V$	-2.9A
	135@ $V_{GS} = -2.5V$	-2.3A

## Description

These P-channel HEXFET® Power MOSFETs from International Rectifier utilize advanced processing techniques to achieve the extremely low on-resistance per silicon area. This benefit provides the designer with an extremely efficient device for use in battery and load management applications.

This Dual TSOP-6 package is ideal for applications where printed circuit board space is at a premium and where maximum functionality is required. With two die per package, the IRF5810 can provide the functionality of two SOT-23 packages in a smaller footprint. Its unique thermal design and  $R_{DS(on)}$  reduction enables an increase in current-handling capability.



## Absolute Maximum Ratings

	Parameter	Max.	Units
$V_{DS}$	Drain- Source Voltage	-20	V
$I_D @ T_A = 25^\circ C$	Continuous Drain Current, $V_{GS} @ -4.5V$	-2.9	A
$I_D @ T_A = 70^\circ C$	Continuous Drain Current, $V_{GS} @ -4.5V$	-2.3	
$I_{DM}$	Pulsed Drain Current ①	-11	
$P_D @ T_A = 25^\circ C$	Power Dissipation ③	0.96	W
$P_D @ T_A = 70^\circ C$	Power Dissipation ③	0.62	
	Linear Derating Factor	0.008	mW/°C
$V_{GS}$	Gate-to-Source Voltage	$\pm 12$	V
$T_J, T_{STG}$	Junction and Storage Temperature Range	-55 to + 150	°C

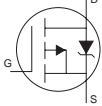
## Thermal Resistance

	Parameter	Max.	Units
$R_{\theta JA}$	Maximum Junction-to-Ambient ③	130	°C/W

## Electrical Characteristics @ $T_J = 25^\circ\text{C}$ (unless otherwise specified)

	Parameter	Min.	Typ.	Max.	Units	Conditions
$V_{(BR)DSS}$	Drain-to-Source Breakdown Voltage	-20	—	—	V	$V_{GS} = 0V, I_D = -250\mu A$
$\Delta V_{(BR)DSS}/\Delta T_J$	Breakdown Voltage Temp. Coefficient	—	0.011	—	V/°C	Reference to $25^\circ\text{C}$ , $I_D = -1mA$
$R_{DS(on)}$	Static Drain-to-Source On-Resistance	—	60	90	mΩ	$V_{GS} = -4.5V, I_D = -2.9 \text{ ②}$
		—	87	135		$V_{GS} = -2.5V, I_D = -2.3A \text{ ②}$
$V_{GS(th)}$	Gate Threshold Voltage	-0.45	—	-1.2	V	$V_{DS} = V_{GS}, I_D = -250\mu A$
$g_{fs}$	Forward Transconductance	5.4	—	—	S	$V_{DS} = -10V, I_D = -2.9A$
$I_{DSS}$	Drain-to-Source Leakage Current	—	—	-1.0	μA	$V_{DS} = -16V, V_{GS} = 0V$
		—	—	-25		$V_{DS} = -16V, V_{GS} = 0V, T_J = 70^\circ\text{C}$
$I_{GSS}$	Gate-to-Source Forward Leakage	—	—	-100	nA	$V_{GS} = -12V$
	Gate-to-Source Reverse Leakage	—	—	100		$V_{GS} = 12V$
$Q_g$	Total Gate Charge	—	6.4	9.6	nC	$I_D = -2.9A$
$Q_{gs}$	Gate-to-Source Charge	—	1.2	1.8		$V_{DS} = -10V$
$Q_{gd}$	Gate-to-Drain ("Miller") Charge	—	1.7	2.6		$V_{GS} = -4.5V$
$t_{d(on)}$	Turn-On Delay Time	—	8.2	—	ns	$V_{DD} = -10V \text{ ②}$
$t_r$	Rise Time	—	14	—		$I_D = -1.0A$
$t_{d(off)}$	Turn-Off Delay Time	—	62	—		$R_G = 6.0\Omega$
$t_f$	Fall Time	—	53	—		$V_{GS} = -4.5V$
$C_{iss}$	Input Capacitance	—	650	—	pF	$V_{GS} = 0V$
$C_{oss}$	Output Capacitance	—	110	—		$V_{DS} = -16V$
$C_{rss}$	Reverse Transfer Capacitance	—	86	—		$f = 1kHz$

## Source-Drain Ratings and Characteristics

	Parameter	Min.	Typ.	Max.	Units	Conditions
$I_S$	Continuous Source Current (Body Diode)	—	—	-1.0	A	MOSFET symbol showing the integral reverse p-n junction diode. 
$I_{SM}$	Pulsed Source Current (Body Diode) ①	—	—	-11		
$V_{SD}$	Diode Forward Voltage	—	—	-1.2	V	$T_J = 25^\circ\text{C}, I_S = -1.0A, V_{GS} = 0V \text{ ②}$
$t_{rr}$	Reverse Recovery Time	—	110	170	ns	$T_J = 25^\circ\text{C}, I_F = -1.0A$
$Q_{rr}$	Reverse Recovery Charge	—	130	200	nC	$di/dt = -100A/\mu s \text{ ②}$

### Notes:

- ① Repetitive rating; pulse width limited by max. junction temperature.
- ② Pulse width  $\leq 400\mu s$ ; duty cycle  $\leq 2\%$ .
- ③ Surface mounted on 1 in square Cu board

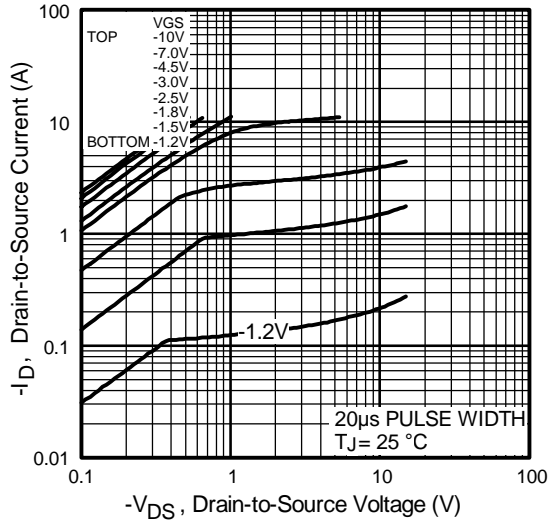


Fig 1. Typical Output Characteristics

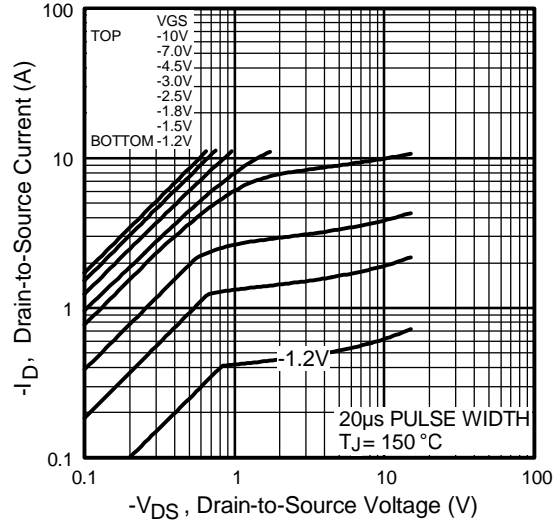


Fig 2. Typical Output Characteristics

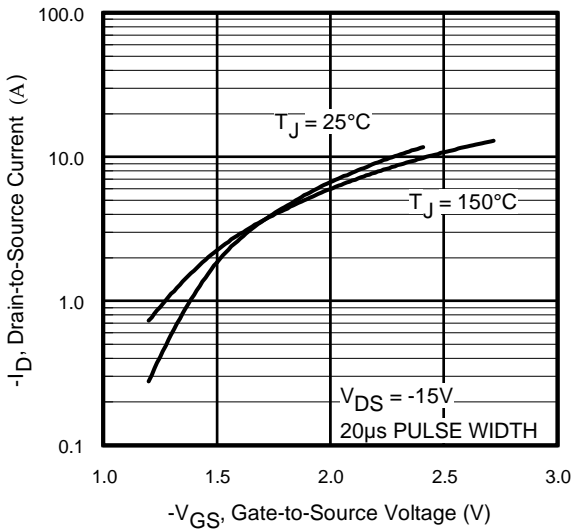


Fig 3. Typical Transfer Characteristics

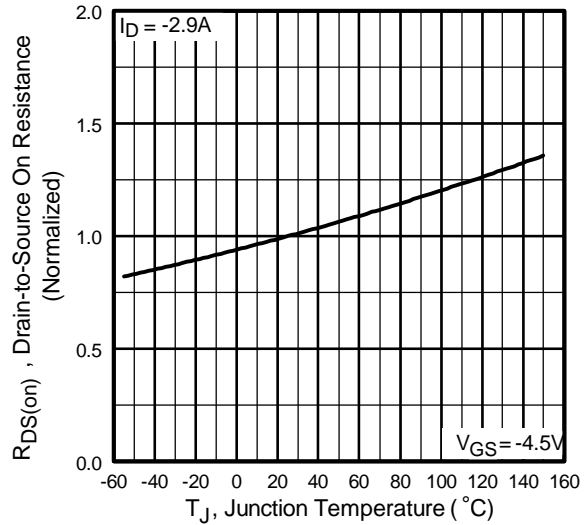
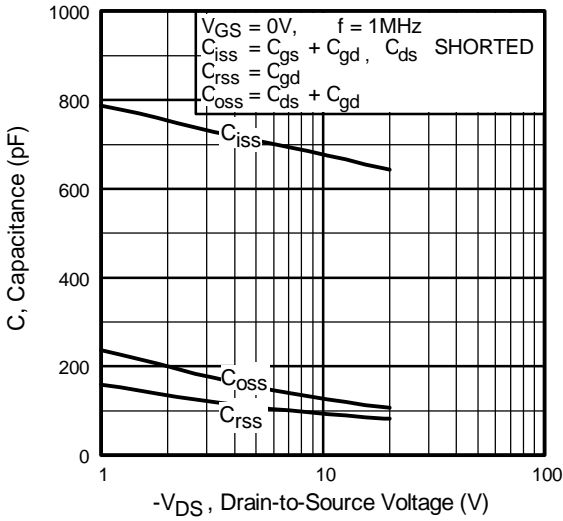
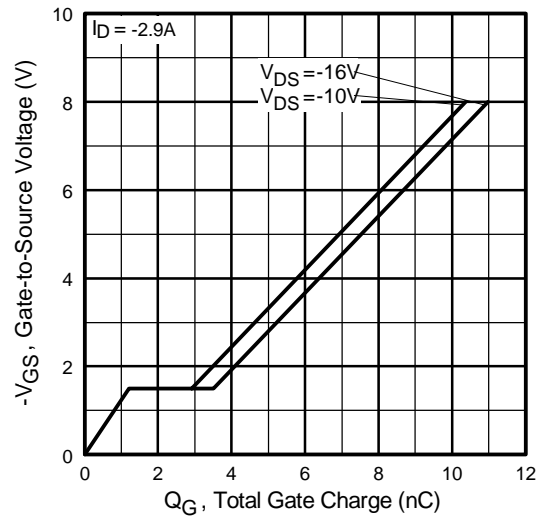


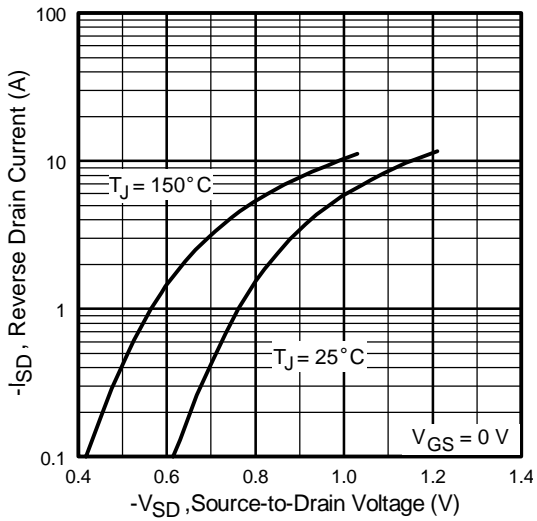
Fig 4. Normalized On-Resistance Vs. Temperature



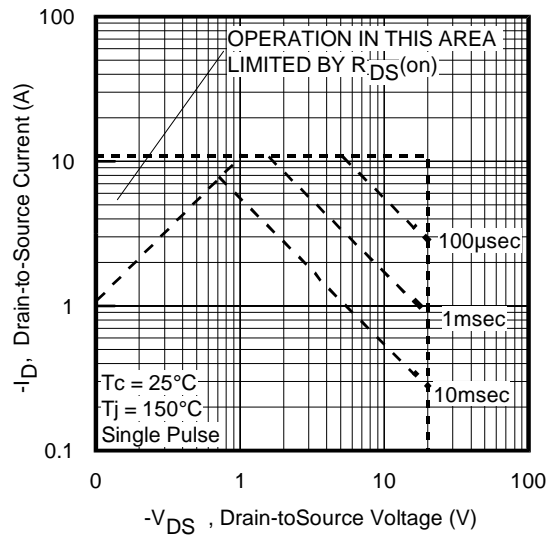
**Fig 5.** Typical Capacitance Vs. Drain-to-Source Voltage



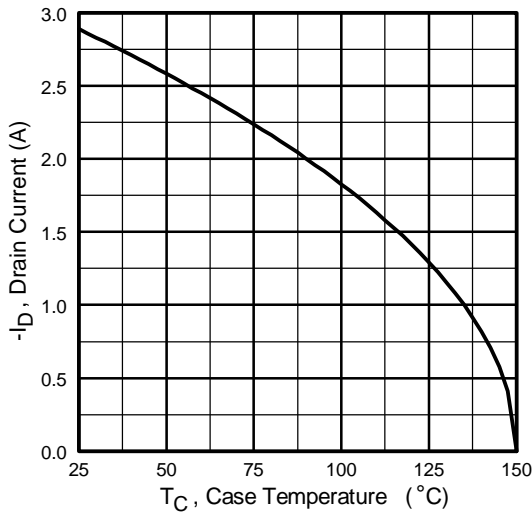
**Fig 6.** Typical Gate Charge Vs. Gate-to-Source Voltage



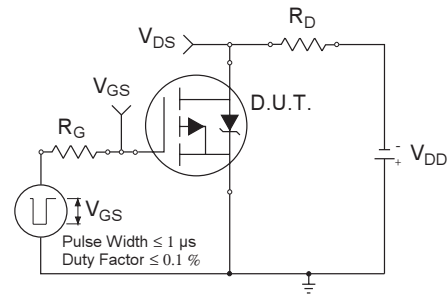
**Fig 7.** Typical Source-Drain Diode Forward Voltage



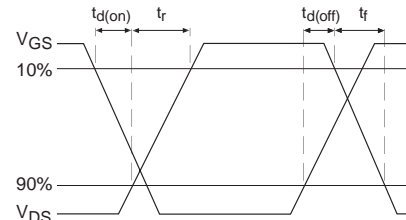
**Fig 8.** Maximum Safe Operating Area



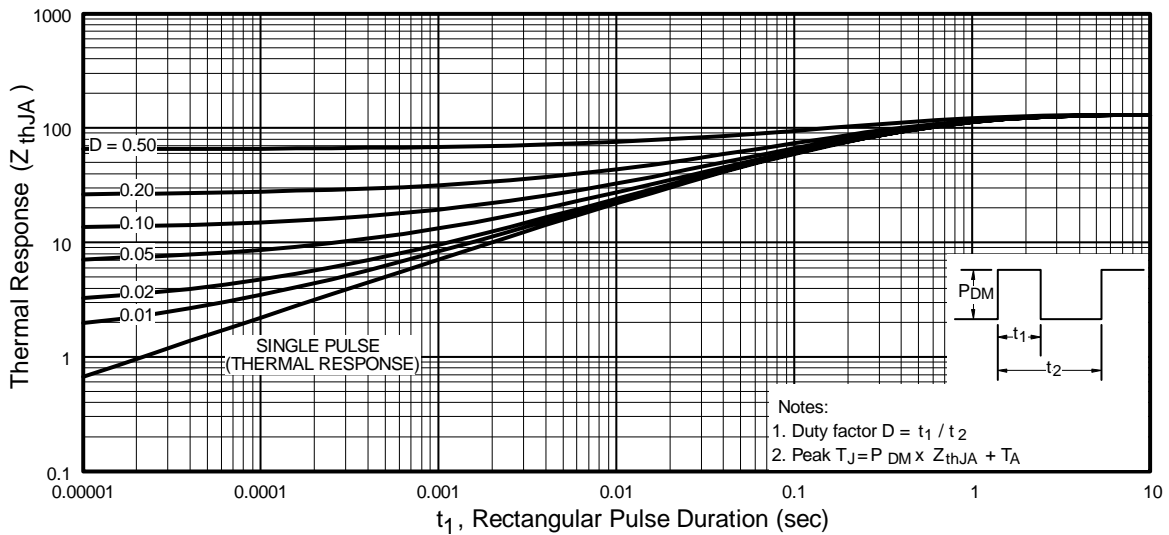
**Fig 9.** Maximum Drain Current Vs. Case Temperature



**Fig 10a.** Switching Time Test Circuit

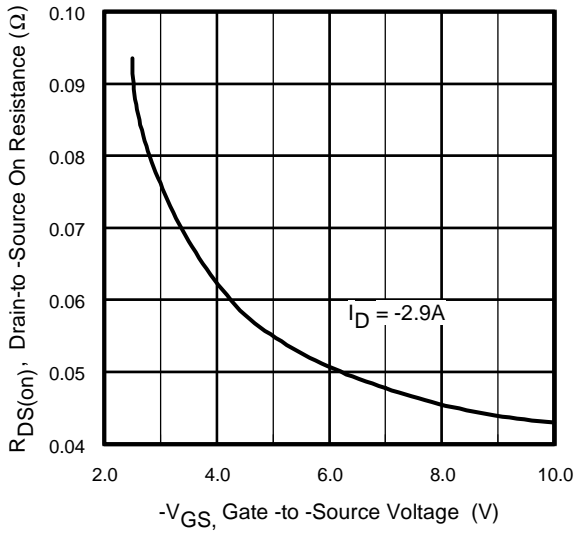


**Fig 10b.** Switching Time Waveforms

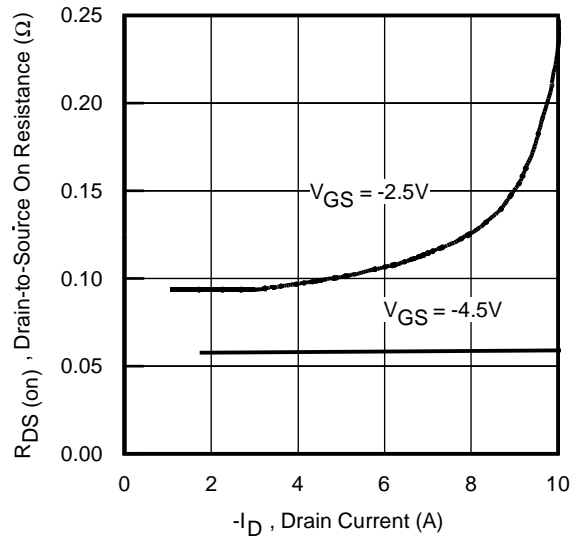


**Fig 11.** Typical Effective Transient Thermal Impedance, Junction-to-Ambient

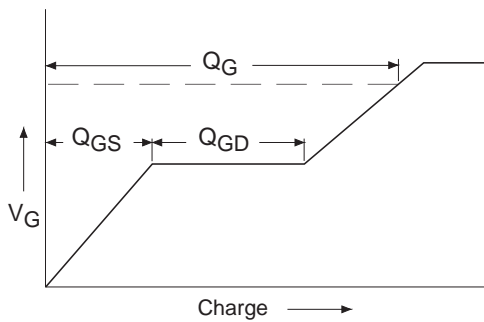
# IRF5810



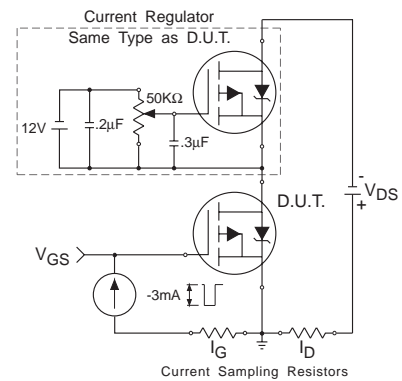
**Fig 12.** Typical On-Resistance Vs. Gate Voltage



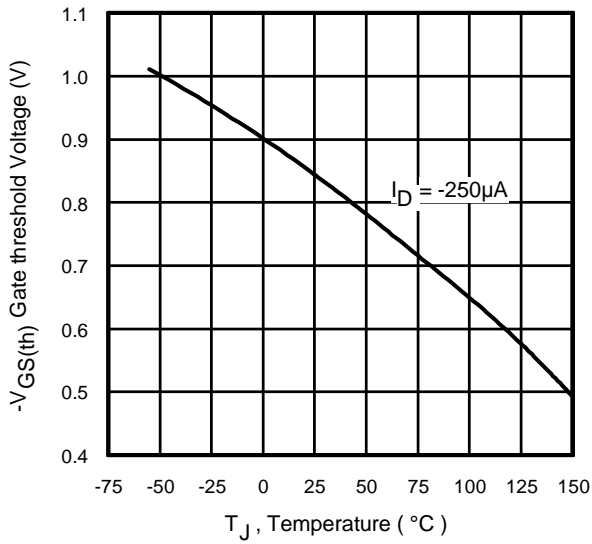
**Fig 13.** Typical On-Resistance Vs. Drain Current



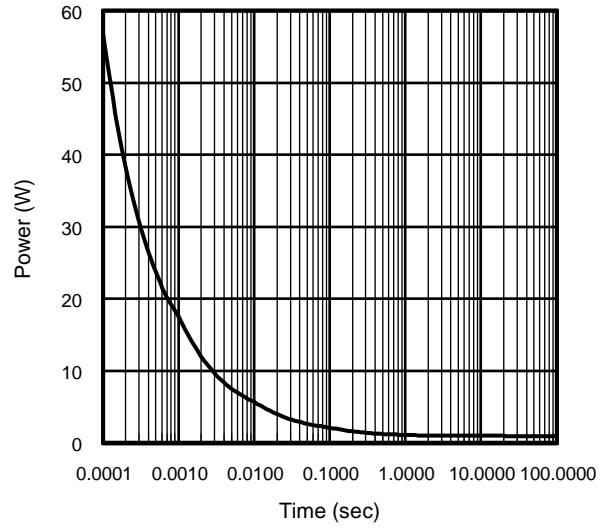
**Fig 14a.** Basic Gate Charge Waveform



**Fig 14b.** Gate Charge Test Circuit



**Fig 15.** Threshold Voltage Vs. Temperature

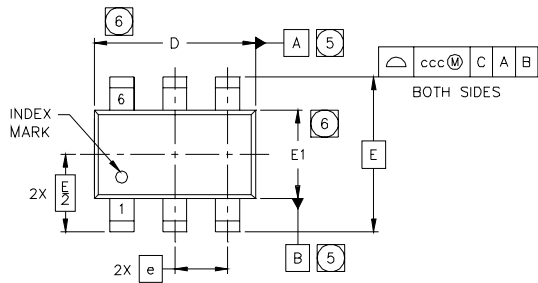


**Fig 16.** Typical Power Vs. Time

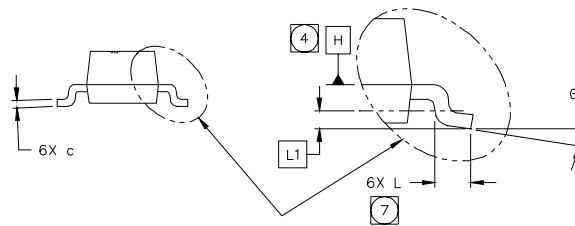
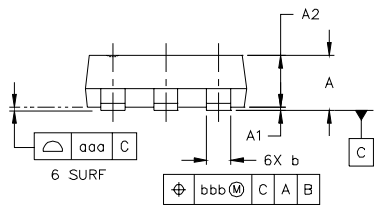
# IRF5810

International  
**IR** Rectifier

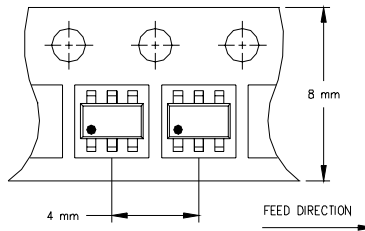
## TSOP-6 Package Outline



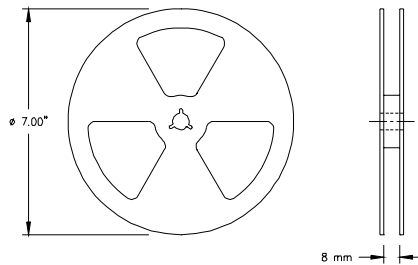
SYMBOL	MO-193AA DIMENSIONS					
	MILLIMETERS			INCHES		
	MIN	NOM	MAX	MIN	NOM	MAX
A	---	---	1.10	---	---	.0433
A1	0.01	---	0.10	.0004	---	.0039
A2	0.80	0.90	1.00	.0315	.0354	.0393
b	0.25	---	0.50	.0099	---	.0196
c	0.10	---	0.26	.004	---	.010
D	2.90	3.00	3.10	.115	.118	.122
E	2.75 BSC			.108 BSC		
E1	1.30	1.50	1.70	.052	.059	.066
e	1.00 BSC			.039 BSC		
L	0.20	0.40	0.60	.0079	.0157	.0236
L1	0.30 BSC			.0118 BSC		
θ	0°	---	8°	0°	---	8°
aaa	0.10			.004		
bbb	0.15			.006		
ccc	0.25			.010		



## TSOP-6 Tape & Reel Information



NOTES:  
1. OUTLINE CONFORMS TO EIA-481 & EIA-541.



NOTES:  
1. OUTLINE CONFORMS TO EIA-481 & EIA-541.

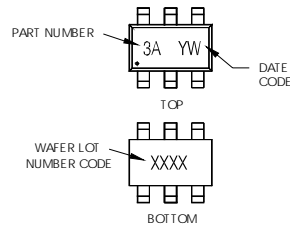


## TSOP-6 Part Marking Information

Notes: This part marking information applies to devices produced before 02/26/2001

EXAMPLE: THIS IS AN S13443DV

WW = (1-26) IF PRECEDED BY LAST DIGIT OF CALENDAR YEAR



PART NUMBER CODE REFERENCE:

3A = S13443DV  
 3B = IRF5800  
 3C = IRF5850  
 3D = IRF5851  
 3E = IRF5852  
 3I = IRF5805  
 3J = IRF5806

DATE CODE EXAMPLES:

YWW = 9603 = 6C  
 YWW = 9632 = FF

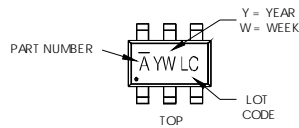
YEAR	Y	WORK WEEK	W
2001	1	01	A
2002	2	02	B
2003	3	03	C
2004	4	04	D
2005	5		
1996	6		
1997	7		
1998	8		
1999	9		
2000	0	24	X
		25	Y
		26	Z

WW = (27-52) IF PRECEDED BY A LETTER

YEAR	Y	WORK WEEK	W
2001	A	27	A
2002	B	28	B
2003	C	29	C
2004	D	30	D
2005	E		
1996	F		
1997	G		
1998	H		
1999	J		
2000	K	50	X
		51	Y
		52	Z

Notes: This part marking information applies to devices produced after 02/26/2001

W = (1-26) IF PRECEDED BY LAST DIGIT OF CALENDAR YEAR



PART NUMBER CODE REFERENCE:

$\bar{A}$  = S13443DV  
 $\bar{B}$  = IRF5800  
 $\bar{C}$  = IRF5850  
 $\bar{D}$  = IRF5851  
 $\bar{E}$  = IRF5852  
 $\bar{I}$  = IRF5805  
 $\bar{J}$  = IRF5806  
 $\bar{K}$  = IRF5810  
 $\bar{L}$  = IRF5804  
 $\bar{M}$  = IRF5803  
 $\bar{N}$  = IRF5820

YEAR	Y	WORK WEEK	W
2001	1	01	A
2002	2	02	B
2003	3	03	C
2004	4	04	D
2005	5		
1996	6		
1997	7		
1998	8		
1999	9		
2000	0	24	X
		25	Y
		26	Z

W = (27-52) IF PRECEDED BY A LETTER

YEAR	Y	WORK WEEK	W
2001	A	27	A
2002	B	28	B
2003	C	29	C
2004	D	30	D
2005	E		
1996	F		
1997	G		
1998	H		
1999	J		
2000	K	50	X
		51	Y
		52	Z

Data and specifications subject to change without notice.  
 This product has been designed and qualified for the consumer market.  
 Qualification Standards can be found on IR's Web site.