

DO NOT SCALE FROM THIS PRINT

NOTES:

- HIDDEN LINES ARE USED TO SHOW POLARIZATION WHEN USING -N OPTION.
- ⊙ REPRESENTS A CRITICAL DIMENSION.
- FFSD CABLE ASSEMBLIES ARE LEAD FREE.
- ALL ASSEMBLIES TO BE 100% ELECTRICALLY TESTED FOR SHORTS AND OPENS.
- ⊙ ALL ASSEMBLIES TO BE 100% HI-POT TESTED AT 630V.
- STRAIN RELIEF TO WITHSTAND 5LB[22N] STRAIGHT PULL.
- NOTE DELETED.
- WHEN CUTTING CABLE TO LENGTH, CONDUCTORS SHOULD NOT EXTEND PAST THE CABLE INSULATION, EXTENDING LESS THAN 25% OF CABLE THICKNESS ON CONSECUTIVE AND LESS THAN 50% OF CABLE THICKNESS ON NON-CONSECUTIVE STRANDS IS CONSIDERED A PROCESS INDICATOR.
- REFERENCE FFSD-XX-XX-X-N-XXX FOR CONNECTOR ASSEMBLY DIMENSIONS AND ITS REQUIREMENTS.
- ⊙ COLORED WIRE MUST MATCH FIRST POSITION INDICATOR ON THE FIRST CONNECTOR FOR ALL OPTIONS WITH THE EXCEPTION OF -RW.
- FOR LENGTHS LESS THAN 12.5", TOLERANCE SHALL BE +/- .125, ALL OTHER LENGTHS SHALL BE +/- 1%.

FFSD-XX-X-XX.XX-01-X-X-XXX

No. OF POSITIONS  
-02 THRU -25  
(PER ROW)

END ASSEMBLY  
-S: SINGLE END  
-D: DOUBLE END

ASSEMBLY LENGTH  
(INCLUDES ADDED OPTION LENGTHS)  
ALL OPTIONS THAT USE -D"XX": 4.00 [101.6] MINIMUM  
ALL OTHER OPTIONS: 1.00 [25.4] MINIMUM

LEAD STYLE

PLATING OPTIONS

- LEAVE BLANK FOR STANDARD, USE C-67-L: 10μ" GOLD IN CONTACT AREA TIN IN IDC AREA
- S: USE C-67-S: 30μ" GOLD IN CONTACT AREA TIN IN IDC AREA
- F: USE C-67-F: 3μ" GOLD IN CONTACT AREA TIN IN IDC AREA

OPTION

- RW: REVERSE WIRING (NOT AVAILABLE WITH -RN1 OR -RN2)
- D"XX": DAISY CHAIN (MINIMUM 2.00[50.8], 1.00[25.4] INCREMENTS)
- R: REVERSED (-D"XX" OPTIONAL) (NOT AVAILABLE WITH -M OR -O)
- RN1: REVERSE POLARIZATION NOTCH (NOT AVAILABLE WITH -RW OR -RN2)
- RN2: REVERSE POLARIZATION NOTCH (NOT AVAILABLE WITH -RW OR -RN1)
- M: MIDDLE REVERSE (REQUIRES -D"XX") (NOT AVAILABLE WITH -R OR -O)
- O: OUTSIDE REVERSE (REQUIRES -D"XX") (NOT AVAILABLE WITH -R OR -M)
- SR: STRAIN RELIEF (NOT AVAILABLE WITH -O, -M, -R, OR -D"XX") (SOLD AS ASSEMBLIES ONLY)

STANDARD POLARIZATION NOTCH

- N: POLARIZATION NOTCH (NOT AVAILABLE IN -02 THRU -04) (LEAVE BLANK FOR -02, -03, -04)

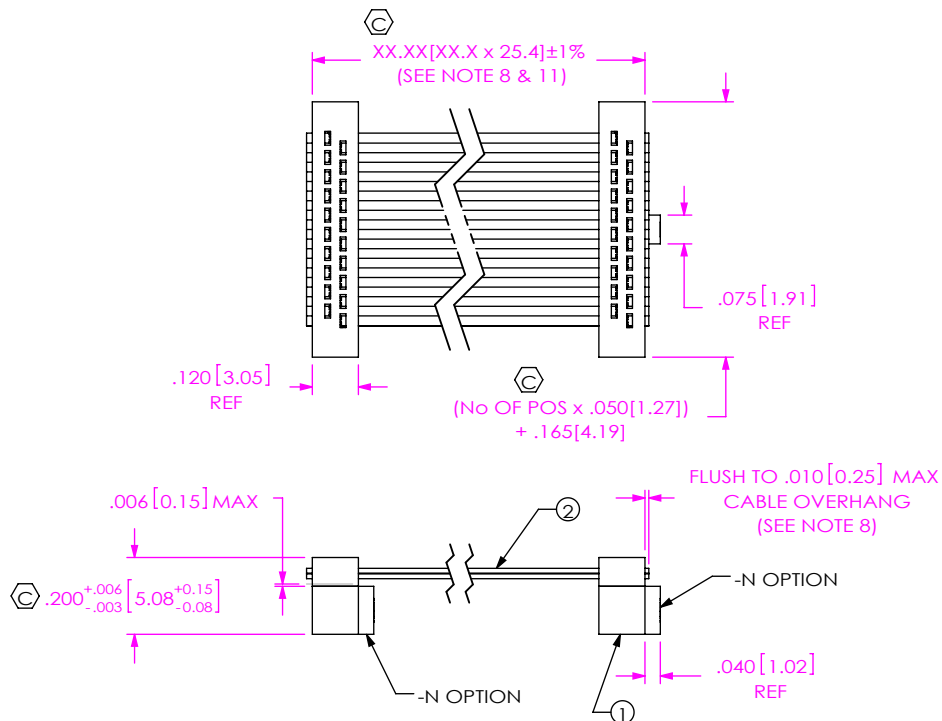

FIG 1  
(FFSD-10-D-XX.XX-01-X-N SHOWN)

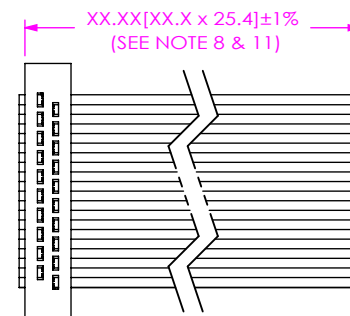
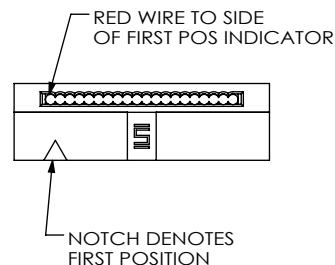

FIG 2  
(FFSD-10-S-XX.XX-01-X-N SHOWN)  
(SAME AS FIG 1, DIFFERENT AS SHOWN)

RED WIRE TO OPPOSITE SIDE OF FIRST POS INDICATOR

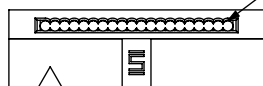

FIG 11

(FFSD-10-X-XX.XX-01-X-N-RW SHOWN)

TABLE 1	
ITEM #	PART
1	FFSD-XX-01-X-N-XX
2	CB-XX-30-7/38-025-GR
3	FFSD-XX-01-X-N-SR1
4	FFSR-XX-01
5	FFSD-XX-01-X-N-SR2
6	FFSR-XX-02

F:\DWG\MISC\MKTG\FFSD-XX-X-XX.XX-01-X-X-XXX-MKT.SLDDRW

UNLESS OTHERWISE SPECIFIED, DIMENSIONS ARE IN INCHES.

TOLERANCES ARE:

DECIMALS ANGLES  
.XX: ±.01[0.3] 2°  
.XXX: ±.005[0.13]  
.XXXX: ±.0020[0.051]

PROPRIETARY NOTE

THIS DOCUMENT CONTAINS CONFIDENTIAL AND PROPRIETARY INFORMATION AND ALL DESIGN, MANUFACTURING, REPRODUCTION, USE, PATENT RIGHTS AND SALES RIGHTS ARE EXPRESSLY RESERVED BY SAMTEC, INC. THIS DOCUMENT SHALL NOT BE DISCLOSED, IN WHOLE OR PART, TO ANY UNAUTHORIZED PERSON OR ENTITY NOR REPRODUCED, TRANSFERRED OR INCORPORATED IN ANY OTHER PROJECT IN ANY MANNER WITHOUT THE EXPRESS WRITTEN CONSENT OF SAMTEC, INC.

MATERIAL: DO NOT SCALE DRAWING SHEET SCALE: 2:1  
INSULATORS: PBT UL94V-0, COLOR: BLACK  
CONTACT: BeCu  
WIRE: 30 AWG, 7/38, TINNED, STRANDED WITH GRAY PVC INSULATOR  
PLATING: .000010 GOLD OVER .000050 NICKEL  
REMAINDER: .000200 REF TIN OVER .000050 NICKEL



520 PARK EAST BLVD, NEW ALBANY, IN 47150  
PHONE: 812-944-6733 FAX: 812-948-5047  
e-Mail info@SAMTEC.com code 53322

DESCRIPTION:  
.050 x .050 DOUBLE ROW FEMALE IDC ASSEMBLY

DWG. NO.  
FFSD-XX-X-XX.XX-01-X-X-XXX

BY: T NEWTON 02/15/2008 SHEET 1 OF 5

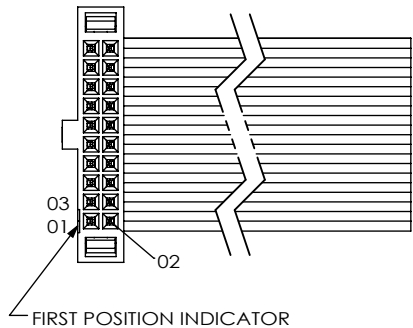
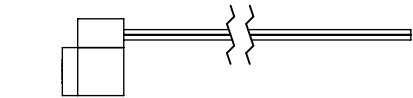

(FFSD-10-S-XX.XX-01-X-N-RN1 SHOWN)  
(SAME AS FIG 2, DIFFERENT AS SHOWN)

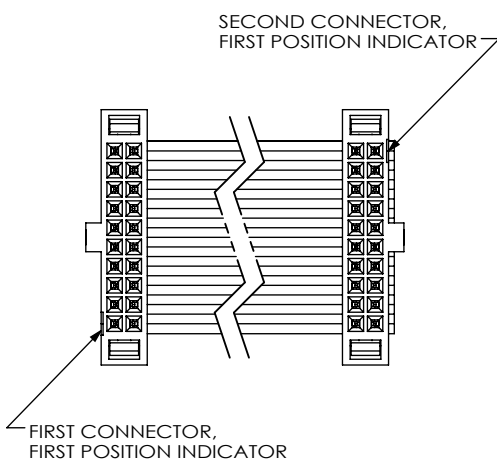
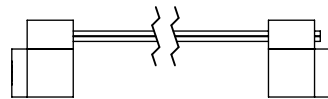

(FFSD-10-D-XX.XX-01-X-N-RN1 SHOWN)  
(SAME AS FIG 1, DIFFERENT AS SHOWN)

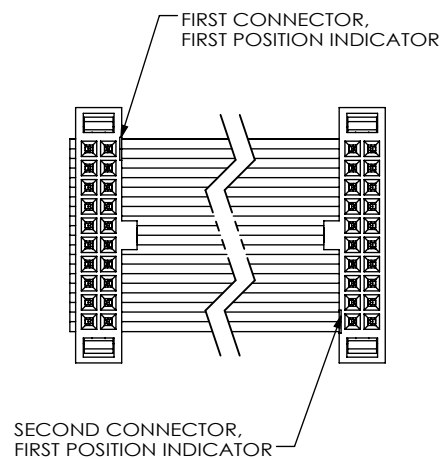
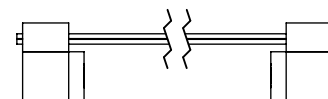

(FFSD-10-D-XX.XX-01-X-N-RN2 SHOWN)  
(SAME AS FIG 1, DIFFERENT AS SHOWN)

**FIG 3**  
(FFSD-10-X-XX.XX-01-X-N-RNX SHOWN)  
(SAME AS FIG 1, DIFFERENT AS SHOWN)  
(REVERSE NOTCH NOT AVAILABLE WITH -RW OR ANY DAISY CHAIN OPTIONS)

- RN1 = REVERSE NOTCH ON 1ST CONNECTOR ONLY  
(NOT AVAILABLE WITH -R OPTION)
- RN2 = REVERSE NOTCH ON 2ND CONNECTOR ONLY  
(NOT AVAILABLE WITH -R OPTION)

**PROPRIETARY NOTE**  
THIS DOCUMENT CONTAINS CONFIDENTIAL AND PROPRIETARY INFORMATION AND ALL DESIGN, MANUFACTURING, REPRODUCTION, USE, PATENT RIGHTS AND SALES RIGHTS ARE EXPRESSLY RESERVED BY SAMTEC, INC. THIS DOCUMENT SHALL NOT BE DISCLOSED, IN WHOLE OR PART, TO ANY UNAUTHORIZED PERSON OR ENTITY NOR REPRODUCED, TRANSFERRED OR INCORPORATED IN ANY OTHER PROJECT IN ANY MANNER WITHOUT THE EXPRESS WRITTEN CONSENT OF SAMTEC, INC.

DO NOT SCALE DRAWING

SHEET SCALE: 2:1



520 PARK EAST BLVD, NEW ALBANY, IN 47150  
PHONE: 812-944-6733 FAX: 812-948-5047  
e-Mail info@SAMTEC.com code 55322

DESCRIPTION:  
.050 x .050 DOUBLE ROW FEMALE IDC ASSEMBLY

DWG. NO.  
FFSD-XX-X-XX.XX-01-X-X-XXX

BY: T NEWTON 02/15/2008 SHEET 2 OF 5

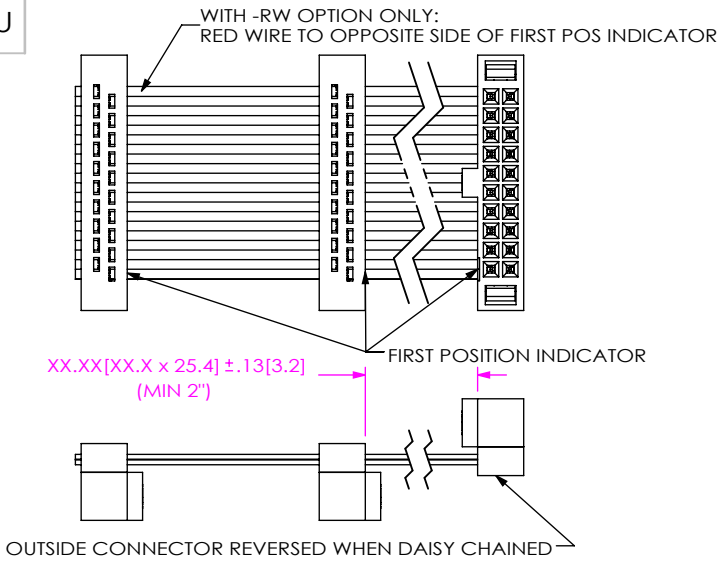

**FIG 4**  
 (FFSD-10-D-XX.XX-01-X-N-DXX-O SHOWN)  
 (SAME AS FIG 1, DIFFERENT AS SHOWN)  
 (2.00[50.8] MINIMUM, 1.00[25.4] INCREMENTS)

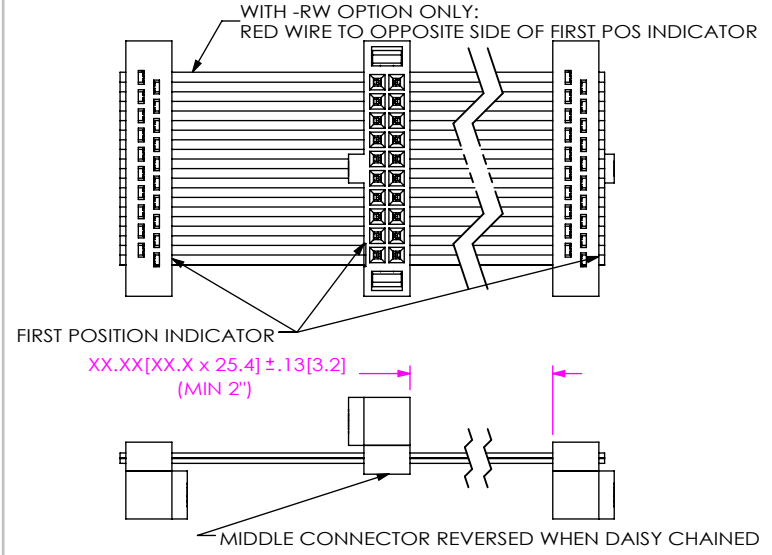

**FIG 5**  
 (FFSD-10-D-XX.XX-01-X-N-DXX-M SHOWN)  
 (SAME AS FIG 1, DIFFERENT AS SHOWN)  
 (2.00[50.8] MINIMUM, 1.00[25.4] INCREMENTS)

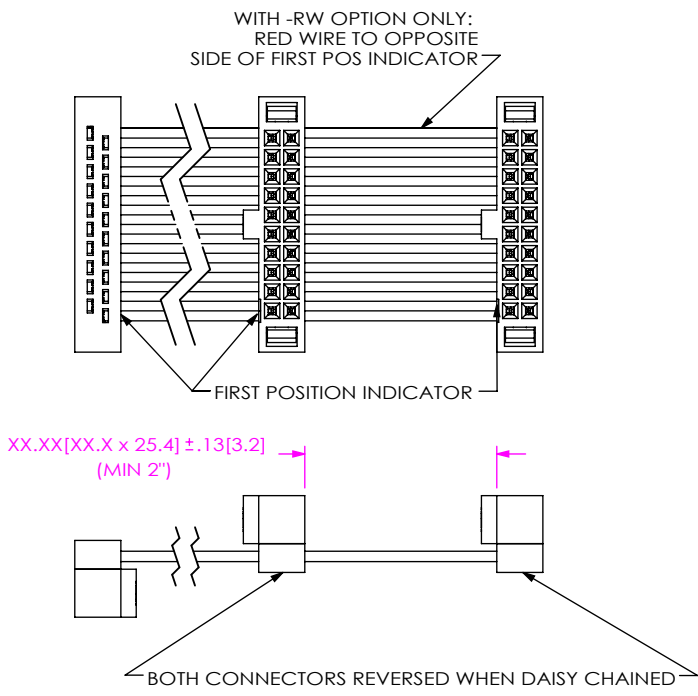

**FIG 6**  
 (FFSD-10-D-XX.XX-01-X-N-DXX-R SHOWN)  
 (SAME AS FIG 1, DIFFERENT AS SHOWN)  
 (NOT AVAILABLE WITH -RN1 OR -RN2 OPTION)  
 (2.00[50.8] MINIMUM, 1.00[25.4] INCREMENTS)

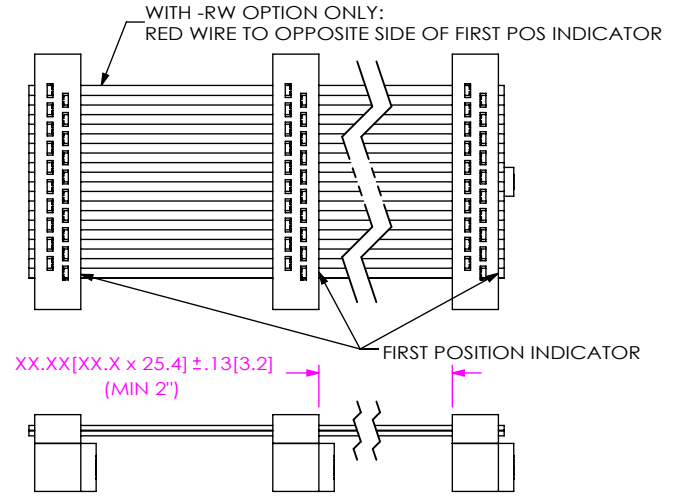

**FIG 7**  
 (FFSD-10-D-XX.XX-01-X-N-DXX SHOWN)  
 (SAME AS FIG 1, DIFFERENT AS SHOWN)  
 (2.00[50.8] MINIMUM, 1.00[25.4] INCREMENTS)

**PROPRIETARY NOTE**  
 THIS DOCUMENT CONTAINS CONFIDENTIAL AND PROPRIETARY INFORMATION AND ALL DESIGN, MANUFACTURING, REPRODUCTION, USE, PATENT RIGHTS AND SALES RIGHTS ARE EXPRESSLY RESERVED BY SAMTEC, INC. THIS DOCUMENT SHALL NOT BE DISCLOSED, IN WHOLE OR PART, TO ANY UNAUTHORIZED PERSON OR ENTITY NOR REPRODUCED, TRANSFERRED OR INCORPORATED IN ANY OTHER PROJECT IN ANY MANNER WITHOUT THE EXPRESS WRITTEN CONSENT OF SAMTEC, INC.  
 DO NOT SCALE DRAWING  
 SHEET SCALE: 2:1



520 PARK EAST BLVD, NEW ALBANY, IN 47150  
 PHONE: 812-944-6733 FAX: 812-948-5047  
 e-Mail info@SAMTEC.com code 55322

DESCRIPTION:  
 .050 x .050 DOUBLE ROW FEMALE IDC ASSEMBLY

DWG. NO.  
**FFSD-XX-X-XX.XX-01-X-X-XXX**

BY: T NEWTON 02/15/2008 SHEET 3 OF 5

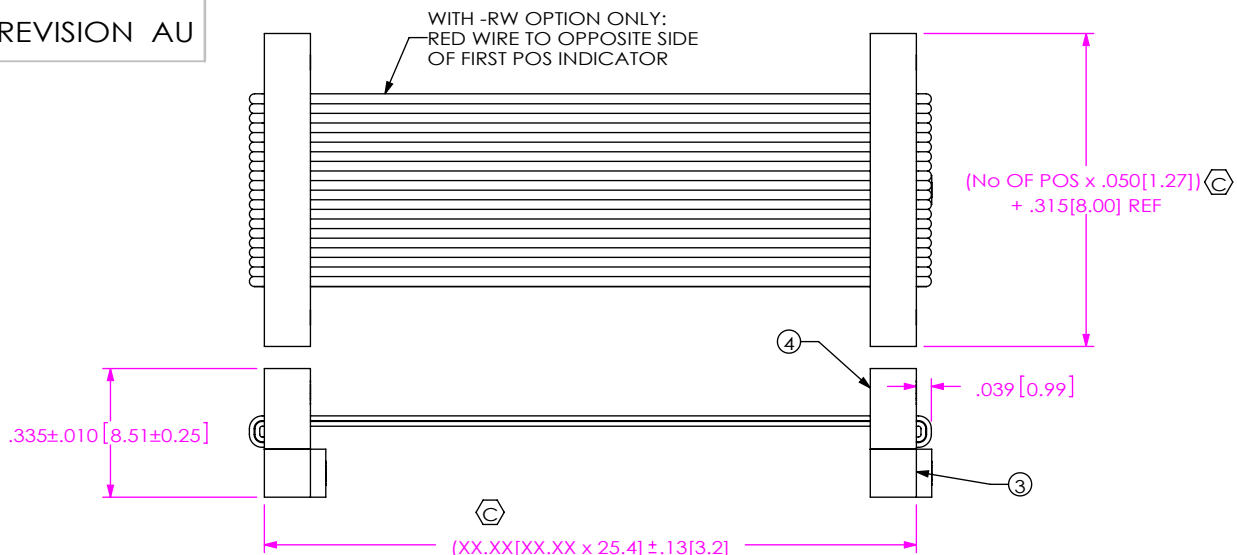

**FIG 9**  
 STRAIN RELIEF OPTION (POS 2-15 ONLY)  
 (FFSD-10-D-XX.XX-01-X-N-SR SHOWN)  
 (SAME AS FIG 1, DIFFERENT AS SHOWN)

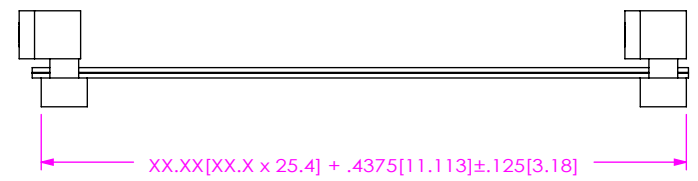

**IN-PROCESS 1**  
 (2-15 POS -SR ONLY FOR DOUBLE END)

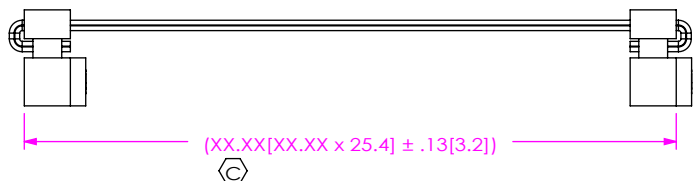

**IN-PROCESS 2**  
 (2-15 POS -SR ONLY FOR DOUBLE END)

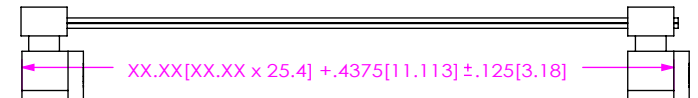

**IN-PROCESS 1**  
 (16-25 POS -SR ONLY FOR DOUBLE END)

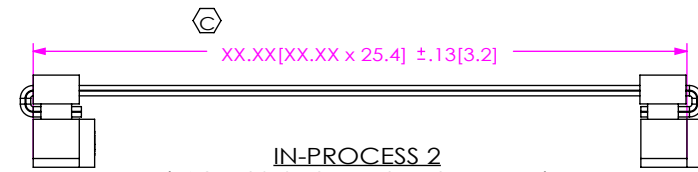

**IN-PROCESS 2**  
 (16-25 POS -SR ONLY FOR DOUBLE END)



**IN-PROCESS 3**  
 (16-25 POS -SR ONLY FOR DOUBLE END)

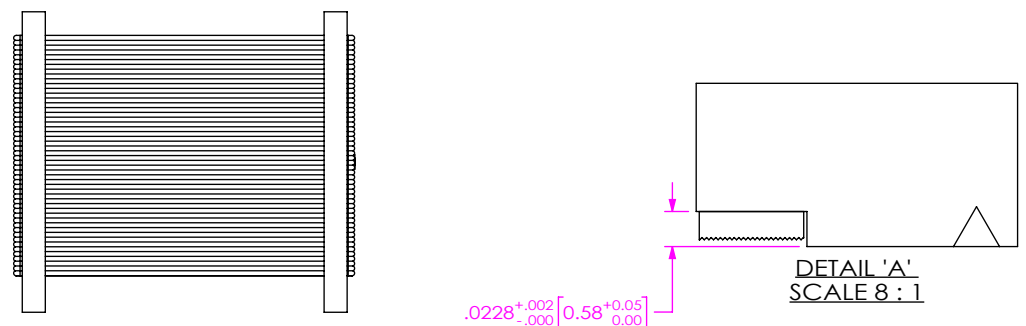

**DETAIL 'A'**  
 SCALE 8 : 1

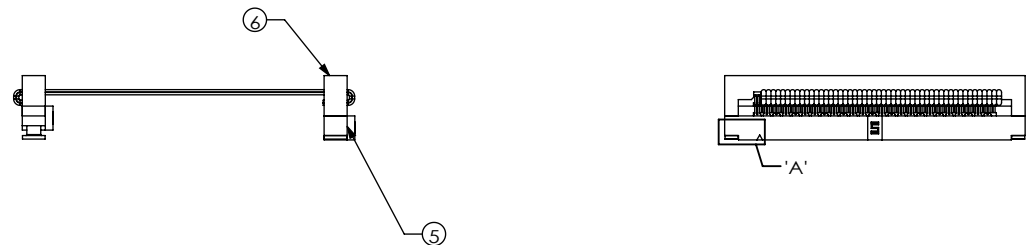

**FIG 10**  
 STRAIN RELIEF OPTION (POS 16-25 ONLY)  
 (FFSD-25-D-XX.XX-01-X-N-SR SHOWN)  
 (SAME AS FIG 9, DIFFERENT AS SHOWN)  
 SCALE 1 : 1

**PROPRIETARY NOTE**  
 THIS DOCUMENT CONTAINS CONFIDENTIAL AND PROPRIETARY INFORMATION AND ALL DESIGN, MANUFACTURING, REPRODUCTION, USE, PATENT RIGHTS AND SALES RIGHTS ARE EXPRESSLY RESERVED BY SAMTEC, INC. THIS DOCUMENT SHALL NOT BE DISCLOSED, IN WHOLE OR PART, TO ANY UNAUTHORIZED PERSON OR ENTITY NOR REPRODUCED, TRANSFERRED OR INCORPORATED IN ANY OTHER PROJECT IN ANY MANNER WITHOUT THE EXPRESS WRITTEN CONSENT OF SAMTEC, INC.

DO NOT SCALE DRAWING

SHEET SCALE: 2:1



520 PARK EAST BLVD, NEW ALBANY, IN 47150  
 PHONE: 812-944-6733 FAX: 812-948-5047  
 e-Mail info@SAMTEC.com code 55322

DESCRIPTION:  
 .050 x .050 DOUBLE ROW FEMALE IDC ASSEMBLY

DWG. NO.  
**FFSD-XX-X-XX.XX-01-X-X-XXX**

BY: T NEWTON 02/15/2008 SHEET 4 OF 5

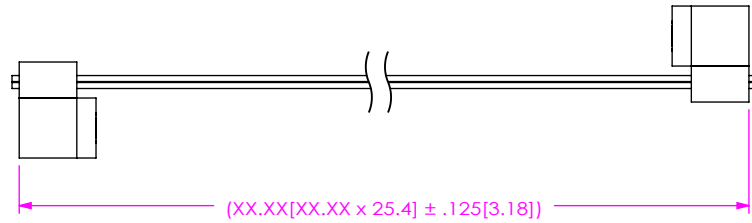

**IN-PROCESS 1**  
(FFSD-XX-S-XX.XX-01-X-N-RW ONLY)

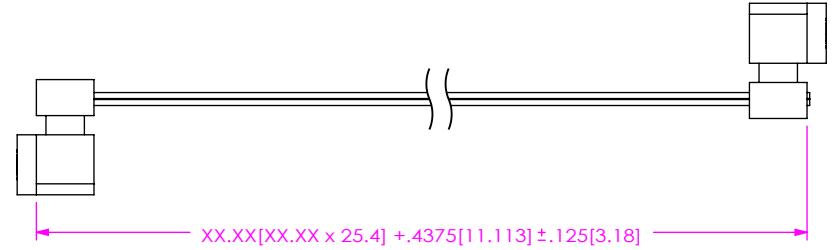

**IN-PROCESS 1**  
(16-25 POS -SR ONLY FOR SINGLE END)

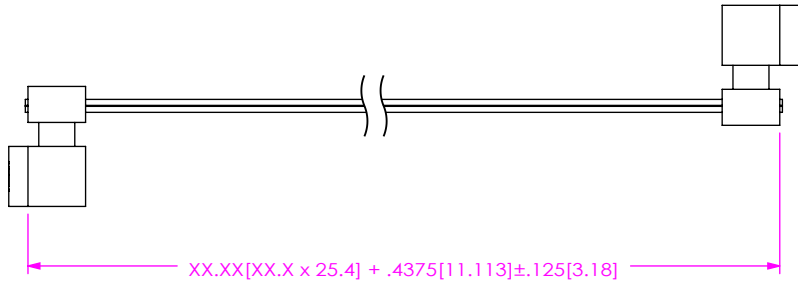

**IN-PROCESS 1**  
(2-15 POS -SR ONLY FOR SINGLE END)

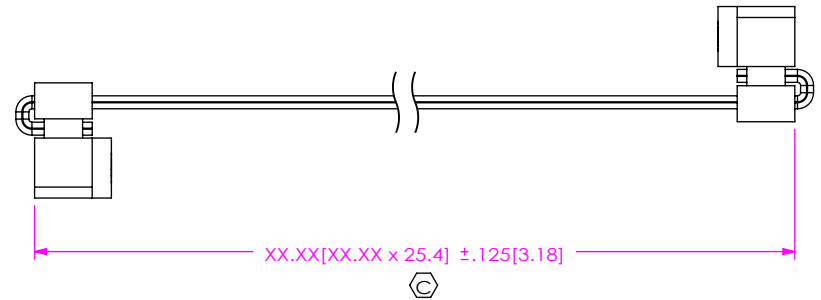

**IN-PROCESS 2**  
(16-25 POS -SR ONLY FOR SINGLE END)

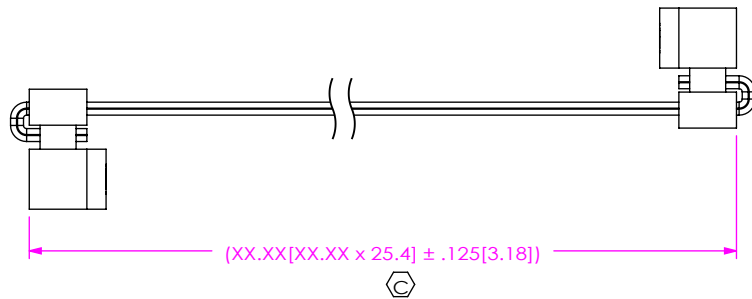

**IN-PROCESS 2**  
(2-15 POS -SR ONLY FOR SINGLE END)

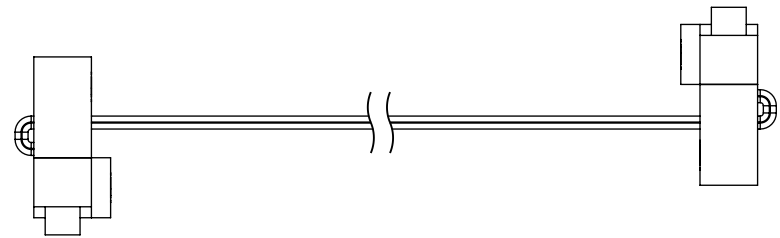

**IN-PROCESS 3**  
(16-25 POS -SR ONLY FOR SINGLE END)

**PROPRIETARY NOTE**  
THIS DOCUMENT CONTAINS CONFIDENTIAL AND PROPRIETARY INFORMATION AND ALL DESIGN, MANUFACTURING, REPRODUCTION, USE, PATENT RIGHTS AND SALES RIGHTS ARE EXPRESSLY RESERVED BY SAMTEC, INC. THIS DOCUMENT SHALL NOT BE DISCLOSED, IN WHOLE OR PART, TO ANY UNAUTHORIZED PERSON OR ENTITY NOR REPRODUCED, TRANSFERRED OR INCORPORATED IN ANY OTHER PROJECT IN ANY MANNER WITHOUT THE EXPRESS WRITTEN CONSENT OF SAMTEC, INC.

DO NOT SCALE DRAWING

SHEET SCALE: 2.5:1



520 PARK EAST BLVD, NEW ALBANY, IN 47150  
PHONE: 812-944-6733 FAX: 812-948-5047  
e-Mail info@SAMTEC.com code 55322

DESCRIPTION:  
.050 x .050 DOUBLE ROW FEMALE IDC ASSEMBLY

DWG. NO.  
**FFSD-XX-X-XX.XX-01-X-X-XXX**

BY: T NEWTON 02/15/2008 SHEET 5 OF 5