

# HiPerFET™ MOSFET Q2-Class

## IXFR 38N80Q2

$V_{DSS} = 800\text{ V}$   
 $I_{D25} = 28\text{ A}$   
 $R_{DS(on)} = 240\text{ m}\Omega$

$t_{rr} \leq 250\text{ ns}$

(Electrically Isolated Back Surface)

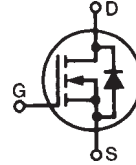

### Preliminary Data Sheet

Symbol	Test Conditions	Maximum Ratings	
$V_{DSS}$	$T_J = 25^\circ\text{C to } 150^\circ\text{C}$	800	V
$V_{DGR}$	$T_J = 25^\circ\text{C to } 150^\circ\text{C}; R_{GS} = 1\text{ M}\Omega$	800	V
$V_{GS}$	Continuous	$\pm 30$	V
$V_{GSM}$	Transient	$\pm 40$	V
$I_{D25}$	$T_C = 25^\circ\text{C}$	28	A
$I_{DM}$	$T_C = 25^\circ\text{C}$ , pulse width limited by $T_{JM}$	150	A
$I_{AR}$	$T_C = 25^\circ\text{C}$	38	A
$E_{AR}$	$T_C = 25^\circ\text{C}$	75	mJ
$E_{AS}$	$T_C = 25^\circ\text{C}$	4.0	J
$dv/dt$	$I_S \leq I_{DM}$ , $di/dt \leq 100\text{ A}/\mu\text{s}$ , $V_{DD} \leq V_{DSS}$ , $T_J \leq 150^\circ\text{C}$ , $R_G = 2\ \Omega$	20	V/ns
$P_D$	$T_C = 25^\circ\text{C}$	416	W
$T_J$		-55 ... +150	$^\circ\text{C}$
$T_{JM}$		150	$^\circ\text{C}$
$T_{stg}$		-55 ... +150	$^\circ\text{C}$
$T_L$	1.6 mm (0.063 in) from case for 10 s	300	$^\circ\text{C}$
$V_{ISOL}$	50/60 Hz, RMS, $t = 1\text{ min}$ $I_{SOL} = 1\text{ mA}$ , $t = 1\text{ s}$	2500 3000	V~ V~
$F_C$	Mounting Force		
<b>Weight</b>		5	g

### ISOPLUS247 (IXFR)

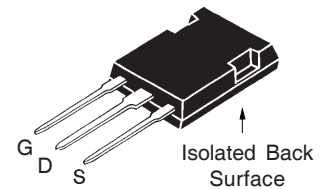

G = Gate                      D = Drain  
S = Source

### Features

- Double metal process for low gate resistance
- Silicon chip on DCB substrate
  - High power dissipation
  - Isolated mounting surface
  - 2500V electrical isolation
- Epoxy meet UL 94 V-0, flammability classification
- Avalanche energy and current rated
- Fast intrinsic Rectifier

### Advantages

- Easy assembly
- Space savings
- High power density

Symbol	Test Conditions	Characteristic Values ( $T_J = 25^\circ\text{C}$ , unless otherwise specified)		
		min.	typ.	max.
$V_{DSS}$	$V_{GS} = 0\text{ V}$ , $I_D = 3\text{ mA}$	800		V
$V_{GS(th)}$	$V_{DS} = V_{GS}$ , $I_D = 8\text{ mA}$	2.0		V
$I_{GSS}$	$V_{GS} = \pm 30\text{ V}_{DC}$ , $V_{DS} = 0$			$\pm 200\text{ nA}$
$I_{DSS}$	$V_{DS} = V_{DSS}$ , $T_J = 25^\circ\text{C}$ $V_{GS} = 0\text{ V}$ , $T_J = 125^\circ\text{C}$			50 $\mu\text{A}$ 2 mA
$R_{DS(on)}$	$V_{GS} = 10\text{ V}$ , $I_D = I_T$ Pulse test, $t \leq 300\ \mu\text{s}$ , duty cycle $d \leq 2\%$			240 m $\Omega$

Symbol	Test Conditions	Characteristic Values ( $T_J = 25^\circ\text{C}$ , unless otherwise specified)		
		min.	typ.	max.
$g_{fs}$	$V_{DS} = 10\text{ V}; I_D = I_T$ , pulse test	25	37	S
$C_{iss}$	$V_{GS} = 0\text{ V}, V_{DS} = 25\text{ V}, f = 1\text{ MHz}$		8340	pF
$C_{oss}$			890	pF
$C_{rss}$			175	pF
$t_{d(on)}$	$V_{GS} = 10\text{ V}, V_{DS} = 0.5 \cdot V_{DSS}, I_D = I_T$ $R_G = 1.0\ \Omega$ (External),		20	ns
$t_r$			16	ns
$t_{d(off)}$			60	ns
$t_f$			12	ns
$Q_{g(on)}$	$V_{GS} = 10\text{ V}, V_{DS} = 0.5 \cdot V_{DSS}, I_D = I_T$		190	nC
$Q_{gs}$			44	nC
$Q_{gd}$			88	nC
$R_{thJC}$			0.3	KW
$R_{thCK}$		0.15		KW

**Source-Drain Diode**

Symbol	Test Conditions	Characteristic Values ( $T_J = 25^\circ\text{C}$ , unless otherwise specified)		
		min.	typ.	max.
$I_S$	$V_{GS} = 0\text{ V}$			38 A
$I_{SM}$	Repetitive; pulse width limited by $T_{JM}$			150 A
$V_{SD}$	$I_F = I_S, V_{GS} = 0\text{ V}$ , Pulse test, $t \leq 300\ \mu\text{s}$ , duty cycle $d \leq 2\%$			1.5 V
$t_{rr}$	$I_F = 25\text{ A}, -di/dt = 100\text{ A}/\mu\text{s}, V_R = 100\text{ V}$			250 ns
$Q_{RM}$			1	$\mu\text{C}$
$I_{RM}$			10	A

Notes: 1. Test current  $I_T = 19\text{ A}$   
2. See IXFK38N80Q2 data sheet for characteristic curves

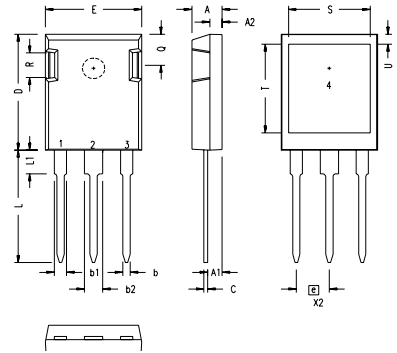
**ISOPLUS247 Outline**

SYM	INCHES		MILLIMETERS	
	MIN	MAX	MIN	MAX
A	.190	.205	4.83	5.21
A1	.090	.100	2.29	2.54
A2	.075	.085	1.91	2.16
b	.045	.055	1.14	1.40
b1	.075	.084	1.91	2.13
b2	.115	.123	2.92	3.12
C	.024	.031	0.61	0.80
D	.819	.840	20.80	21.34
E	.620	.635	15.75	16.13
e	.215 BSC		5.45 BSC	
L	.780	.800	19.81	20.32
L1	.150	.170	3.81	4.32
Q	.220	.244	5.59	6.20
R	.170	.190	4.32	4.83
S	.520	.540	13.21	13.72
T	.620	.640	15.75	16.26
U	.065	.080	1.65	2.03

- 1 - GATE
- 2 - DRAIN (COLLECTOR)
- 3 - SOURCE (EMITTER)
- 4 - NO CONNECTION

NOTE: This drawing will meet all dimensions requirement of JEDEC outline TO-247AD except screw hole.

IXYS reserves the right to change limits, test conditions, and dimensions.

IXYS MOSFETs and IGBTs are covered by one or more of the following U.S. patents:	4,835,592	4,931,844	5,049,961	5,237,481	6,162,665	6,404,065B1	6,683,344	6,727,585
	4,850,072	5,017,508	5,063,307	5,381,025	6,259,123B1	6,534,343	6,710,405B2	6,759,692
	4,881,106	5,034,796	5,187,117	5,486,715	6,306,728 B1	6,583,505	6,710,463	

**Fig. 1. Output Characteristics @ 25°C**

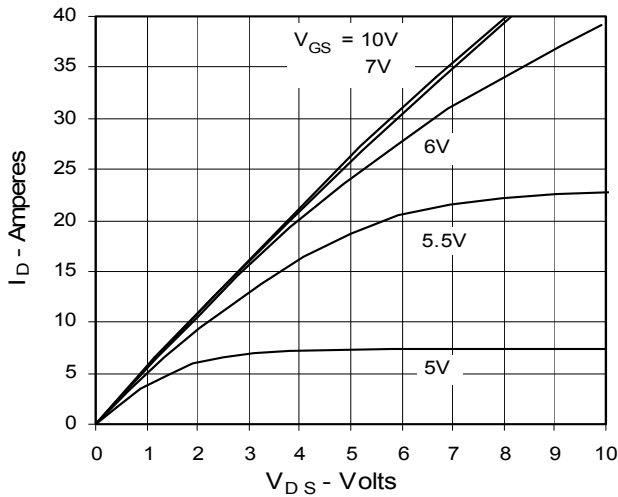

**Fig. 2. Extended Output Characteristics @ 25°C**

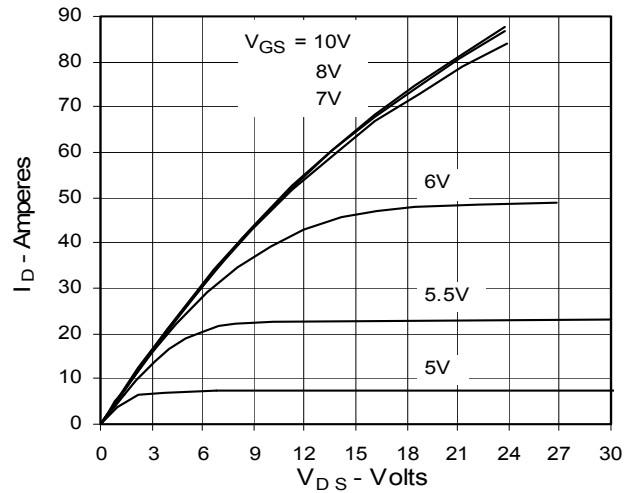

**Fig. 3. Output Characteristics @ 125°C**

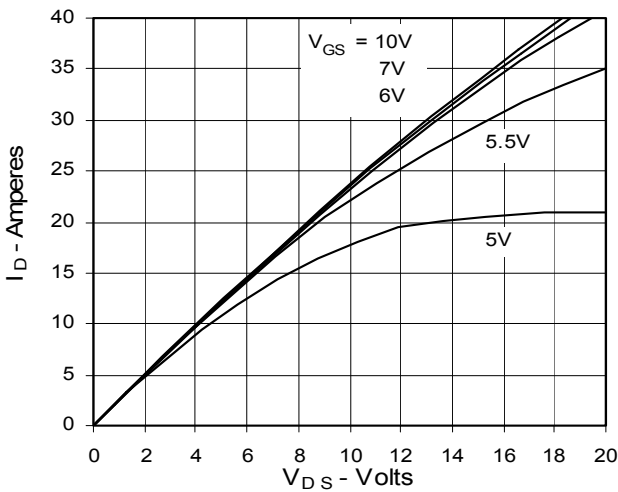

**Fig. 4.  $R_{DS(on)}$  Normalized to 0.5  $I_{D25}$  Value vs. Junction Temperature**

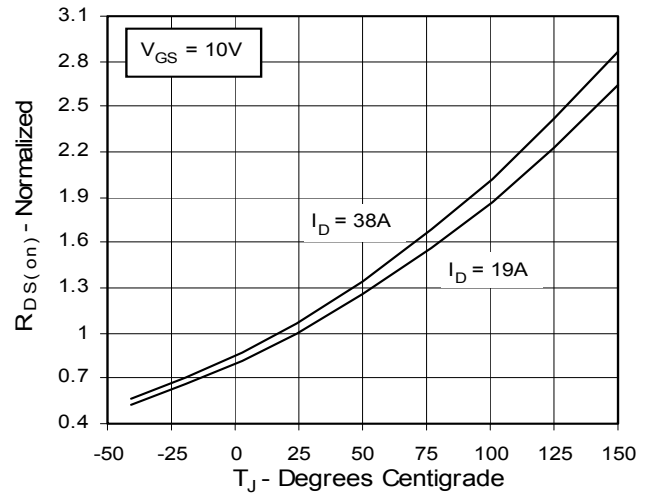

**Fig. 5.  $R_{DS(on)}$  Normalized to 0.5  $I_{D25}$  Value vs.  $I_D$**

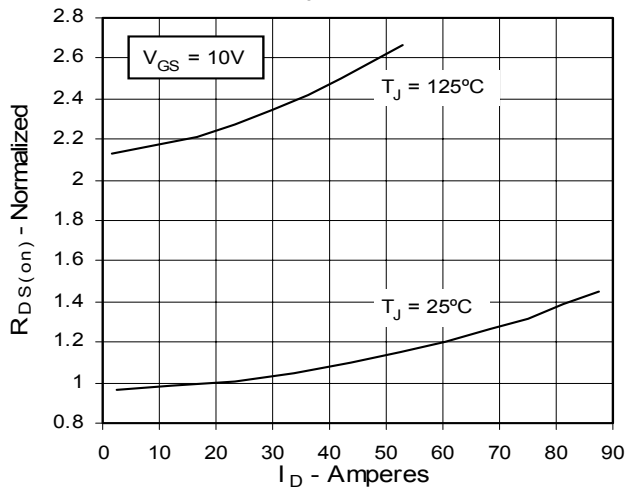

**Fig. 6. Drain Current vs. Case Temperature**

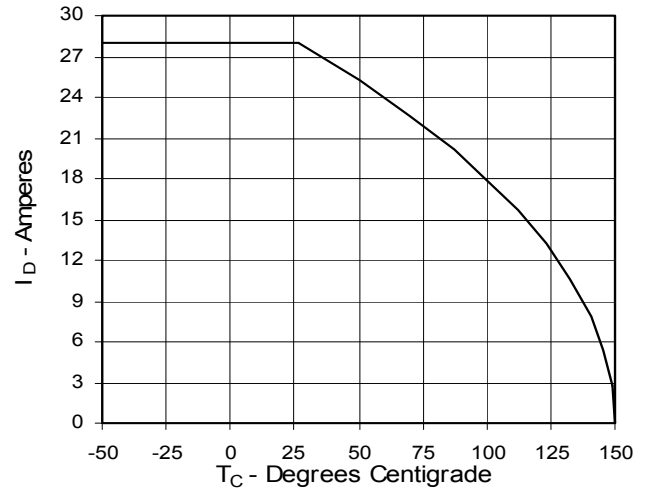

**Fig. 7. Input Admittance**

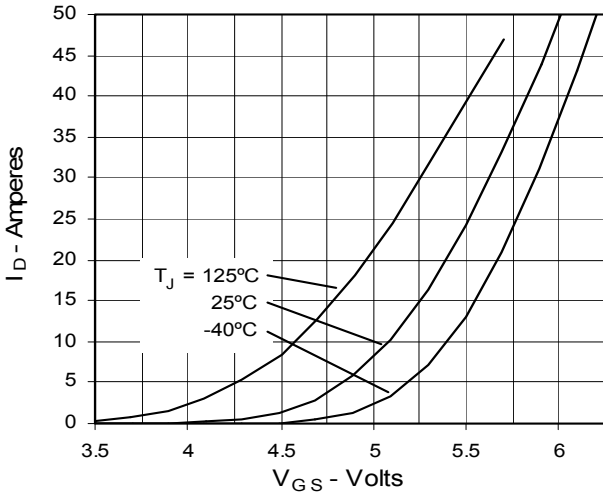

**Fig. 8. Transconductance**

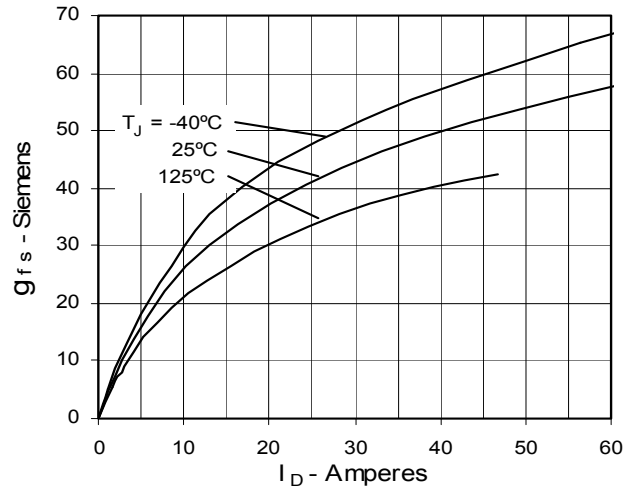

**Fig. 9. Source Current vs. Source-To-Drain Voltage**

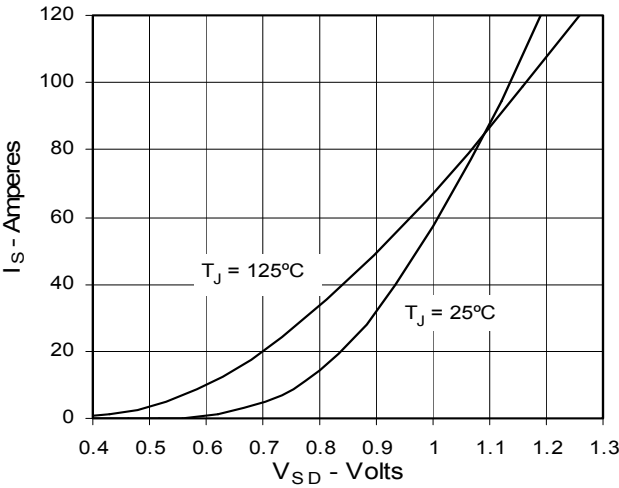

**Fig. 10. Gate Charge**

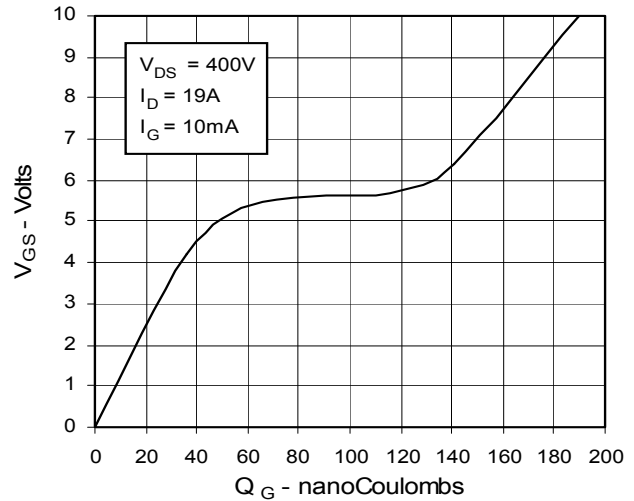

**Fig. 11. Capacitance**

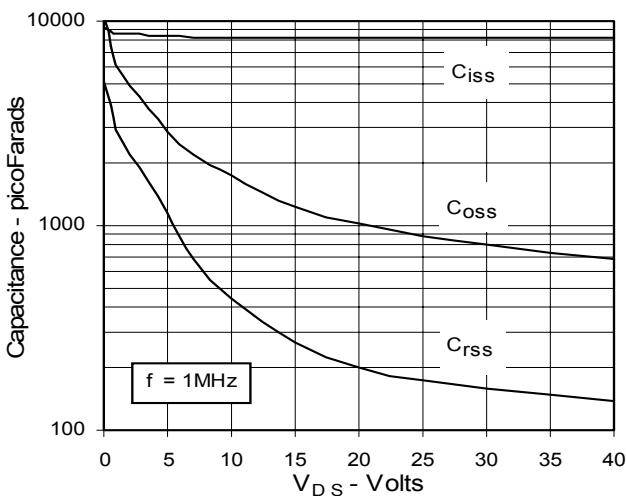

**Fig. 12. Forward-Bias Safe Operating Area**

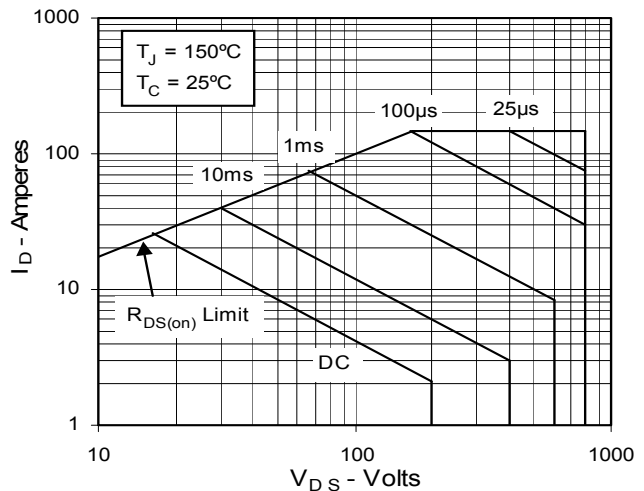

Fig. 13. Maximum Transient Thermal Resistance

