

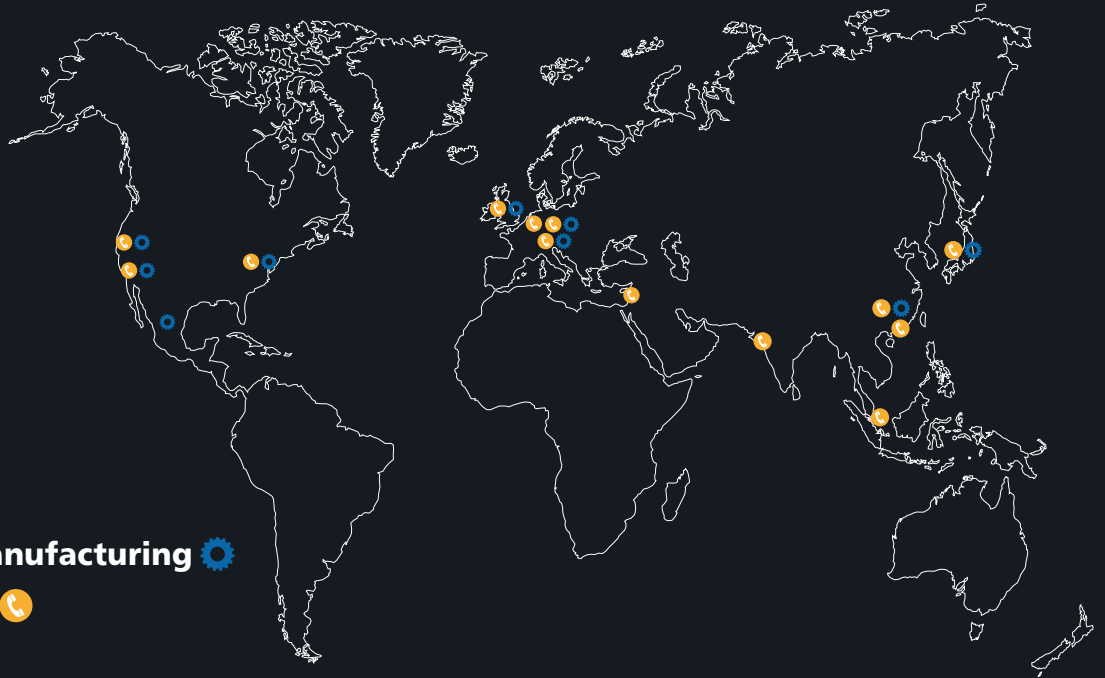

ITT



Global Design & Manufacturing

Customer Support

North America

MEXICO - Cannon, VEAM

Av. Libre Comercio s/n-
entre Calzada Industrial
Nuevo Nogales y Calzada del Raquet Club,
Parque Industrial Nuevo Nogales
phone: +52.631.3110050
fax: +52.631.3110060

USA - Cannon

666 East Dyer Road
Santa Ana, CA 92705
toll free: 1.800.854.3028
phone: +1.714.557.4700
fax: +1.714.628.2142

USA - BIW Connector Systems

500 Tesconi Circle
Santa Rosa, CA 95401
phone: +1.707.523.2300
fax: +1.707.523.3567

USA - Universal Contact

100 New Wood Road
Watertown, CT 06795
phone: +1.860.274.9681
fax: +1.860.274.4963

Europe & Middle East

FRANCE - Cannon, VEAM

15, Boulevard Robert Thiboust
Serris, France 77700
phone: +33.1.60.04.93.93
fax: +33.1.60.04.93.90

GERMANY - Cannon, VEAM

Cannonstrasse 1
Weinstadt, 71384
phone: +49.7151.699.0
fax: +49.7151.699.217

ITALY - VEAM

Corso Europa 41/43
Lainate (MI), Italy 20020
phone: +39.02938721
fax: +39.0293872300

LEBANON - BIW Connector Systems

P.O. Box 199
Jounieh
Lebanon
phone: +961.9.911.560
fax: +961.9.912.126

UK - Cannon, VEAM

Jays Close, Viables Estate
Basingstoke, RG22 4BA
phone: +44.1256.311200
fax: +44.1256.323356

Asia

CHINA - Cannon, VEAM

Tuopandun Industrial Area, Jinda Cheng,
Xiner Village, Shajing Town,
Baoan District, Shenzhen City,
Guangdong, China 518125
phone: +86.755.2726.7238
fax: +86.755.2726.7515

HONG KONG - Cannon, VEAM

Units 2405-6, 24/F, ING Tower
308 Des Voeux Road
Central
Hong Kong
phone: +852.2732.2720
fax: +852.2732.2919

INDIA - Cannon, VEAM

ITT Corporation India Pvt Ltd
2nd Fl Prama House
21 Cama Industrial Estate
Walbhat Road, Goregaon (E),
Mumbai
phone: +91 22 67843000
fax: +91 22 26783033

JAPAN - Cannon, VEAM

11-3, 5 Chome, Hibarigaoka, Zama-shi
Kanagawa, Japan 228-0003
phone: +81.462.57.2010
fax: +81.462.57.1680

SINGAPORE - Cannon, VEAM

10 Jalan Kilang #06-01 Singapore
159410
phone: +65.62763693 ext 232
fax: +65.62763685



ITT

Interconnect Solutions
Canon, VEAM,
BIW Connector Systems

Over four billion
Universal Contacts
in use without a
single failure

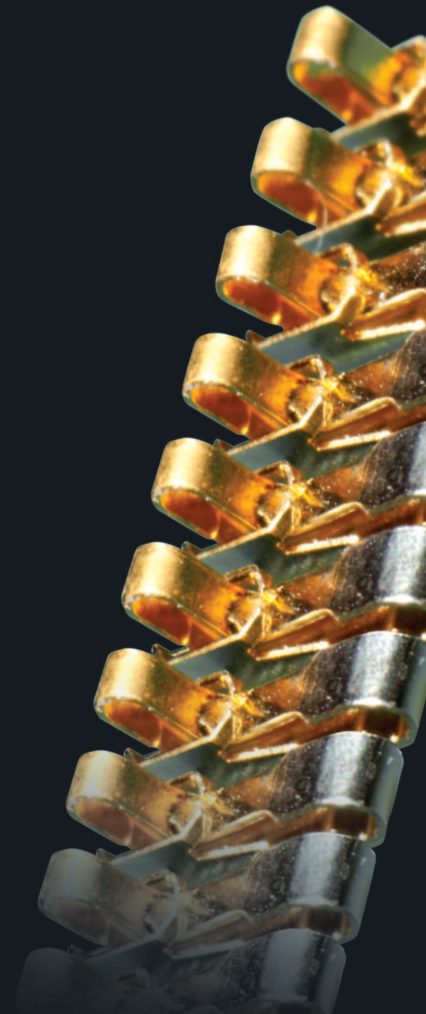

ENGINEERED FOR LIFE

High Hertz Forces – Preload – 1.3mm to 4.6mm Free Heights

Addressing stated commercial customer needs for decreasing product variability across distributed global manufacturing footprints, ITT Interconnect Solutions pioneered the innovative “Universal Contact.” Demonstrating a solid foundation in interconnect science, ITT applied the proven concept of high hertz stress preventing most dry circuit contact failures. Coupling this technology with both wipe and base

material finish considerations, ITT commercialized the Universal Contact as an independent SMT contact providing electrical connectivity between two points. Ensuring specific customer material selection capabilities, this unique product is available in both Beryllium and Titanium Copper alloys. With 0.1mm of movement, the Universal Contact creates 0.3N of force and 300k psi eliminating all issues surrounding life cycle and vibration conditions.

The standard specifications are:

Base Material: BeCu or TiCu

Plating: Selective Gold over Nickel plate

Contact Resistance: < 20 milli ohms

Rating: 2.0 to 3.0 amps depending on the free height

Solder Systems: Infrared and Hot Air re-flow

Operating Temperature: -40C to +85C

Contact Forces: .3N to .9N



100% Reliable Functionality for Critical Commercial Applications

The ITT Interconnect Solutions Universal Contact Series provides over 3,000 mating cycles and is packaged in 12mm wide tape and reels to the EIA-481 standard. Wear resistance is subject to mating surface finish and plating type. With less than 20 milli ohms of contact resistance, pure signal integrity or grounding may be achieved.

When deflected, the Universal Contact provides 0.7N of force with the associated wipe at the specified working ranges ensuring the ultimate interconnect link. Specific models will function under a 40G loading. Over the last 5 years, the Universal Contact boasts the sustained achievement of over 6 sigma PPM results.

WHY INNOVATIVE CUSTOMERS CHOOSE ITT

- Provides overlapping free heights from 1.2 to 4.6mm, replacing traditional interconnect systems such as pogo pins or leaf spring contacts
- Incorporates a domed surface on the contact point beam, maintaining a high hertz stress contact and ensuring functionality during extreme conditions
- Creation of a protective “box” through the incorporation of unique side walls, preventing the beam from being over-stressed and maintaining pre-load to the beam in the unmated condition
- Utilization of a defined solder-well, preventing solder from wicking up the contact and causing variability in the contact forces
- Tight tolerancing on the X-Y-Z movement, allowing for robust connections between the contacts and component assemblies and ensuring outstanding performance during shock and vibration

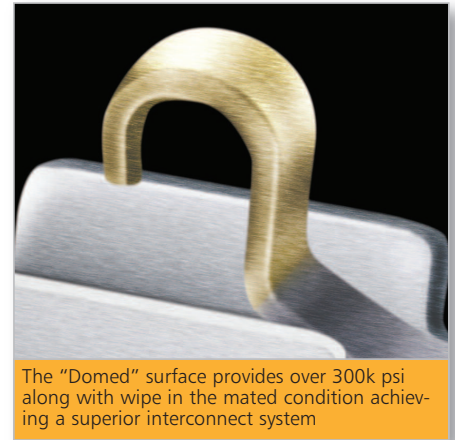

The “Domed” surface provides over 300k psi along with wipe in the mated condition achieving a superior interconnect system

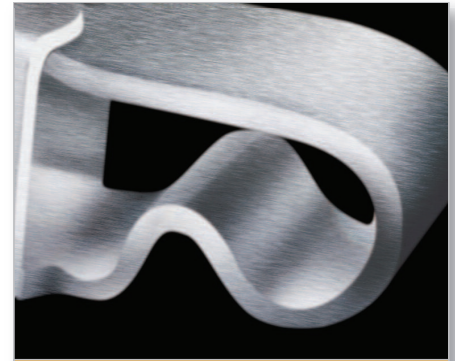

The “solder well” prevents solder paste and flux from wicking up the contact and changing the operating forces

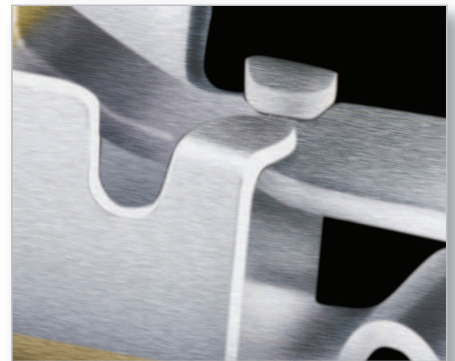

The “side wings” protect the moving beam and prevent the beam from being over-stressed and damaged

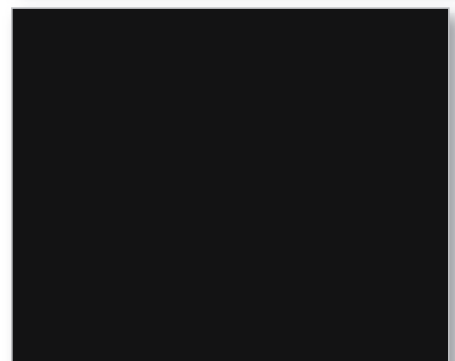

The pitch of the Universal Contacts range from 1.25mm to 1.45mm depending on the free height size

Achieving Manufacturing Repeatability, Efficiency, and Global Footprint Excellence

Contact dimension

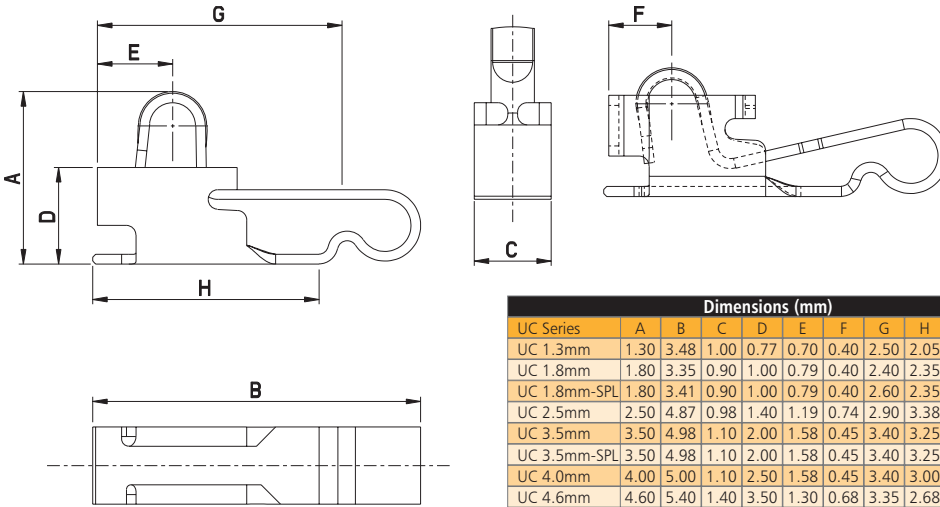

Innovative Functionality & Global Execution

With the ITT Universal Contact series, Interconnect Solutions fields a unique, singular contact design which exhibits over 0.3N of force with only 0.1mm of deflection. Coupled with 300k PSI and defined wiping action when deflected, the Universal Contact provides the ultimate dry circuit pressure contact for commercial and military applications. Rounding out this offering is the capability for nominal working heights ranging

from 0.8mm to 4.2mm. Partnered with ITT ICS's pioneering engineering capability and globally deployed manufacturing excellence, we welcome your opportunity to define, execute, and field the next generation of hand held interconnects and establish the correct supply chain, localized to your unique needs. Over 5 years of production, 6 sigma PPM results.

► For more specifications please see: www.ittcannon.com/...

APPLICATIONS

- Smart Phone
- PDA
- Laptop and Computer
- Home Electronic Devices
- Vehicle Keyfob
- Medical Scanning Equipment
- Bar Code Scanners
- GPS Units
- Set Top Boxes

UNIVERSAL CONTACT USES...

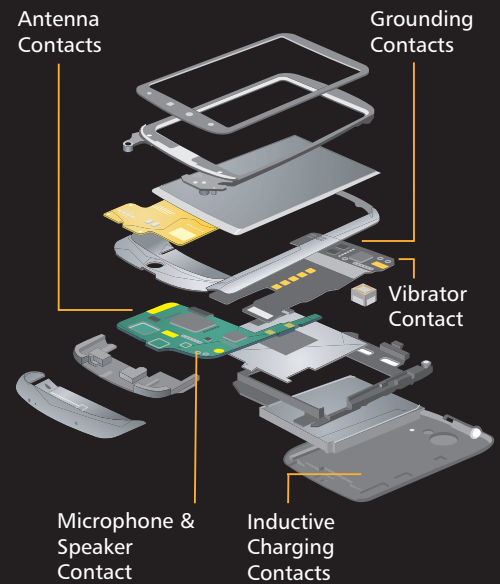

THINK ABOUT ITT

Reliability, Innovation, and Engineered Solutions, these terms collectively describe ITT Interconnect Solutions and define a legacy of Interconnect Science spanning nearly a century, reflecting billions of quality products sold, and incorporating the three industry leading brands of Cannon,

VEAM, and BIW. Our Innovation Timeline uniquely defines a historical compendium of interconnect leadership spanning over 90 years and including many industry firsts; Audio Connectors, Aviation Circulars, D-Sub's, Micro's, fiber optic assemblies, Zero Insertion Force Technologies, and other advanced applications of Interconnect Science. When collaborating with a technology leader, choose a participant with documented trust, established through

multi-industry achievements as substantiated through the participation on every free world space mission, the creation of the first Mil / Spec interconnects, participation on the first talking movie, 100% reliability for over 45 years in Rail applications, and numerous additional achievements in major Military, Aerospace, Industrial, Medical, and Power markets. At ITT ICS, we truly are "Engineered for Life™." Think about ITT.