

DATA SHEET

SKY65094-360LF: 698 to 915 MHz Low-Noise Power Amplifier Driver

Applications

- 2.5G, 3G, 4G wireless infrastructure transceivers
- ISM band transmitters
- WCS fixed wireless
- 3GPP LTE

Features

- Wideband frequency range: 698 to 915 MHz
- Low Noise Figure: 3.2 dB
- High IIP3 up to +29 dBm
- Output P1dB = +25 dBm
- High gain: +17 dB
- Single DC supply: +5 V
- Enable voltage: +3.3 V
- On-chip bias circuit
- DFN (8-pin, 2 x 2 mm) package (MSL1, 260 °C per JEDEC J-STD-020)



Skyworks Green™ products are compliant with all applicable legislation and are halogen-free. For additional information, refer to *Skyworks Definition of Green™*, document number SQ04-0074.

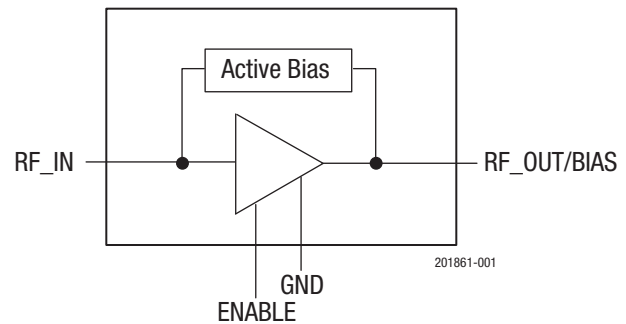

Figure 1. SKY65094-360LF Functional Block Diagram

Description

The Skyworks SKY65094-360LF is a high-performance, ultra-wideband power amplifier (PA) driver with superior output power, low noise, and linearity. The device provides excellent noise figure (NF) and high output power at 1 dB compression, which makes the SKY65094-360LF ideal for use in the driver stage of infrastructure transmit or receive chains.

The SKY65094-360LF uses low-cost surface-mount technology (SMT) in the form of an 8-pin, 2 x 2 mm Dual Flat No-Lead (DFN) package. A functional block diagram is provided in Figure 1, and the device package and pinout are shown in Figure 2. Signal pin assignments and functional pin descriptions are described in Table 1.

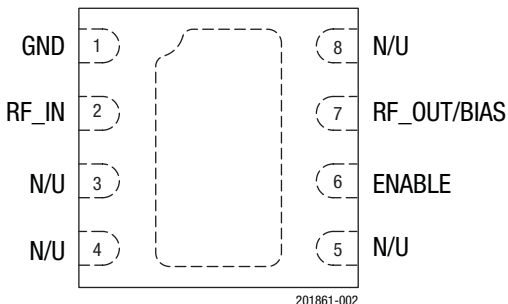

Figure 2. SKY65094-360LF Pinout (Top View)

Table 1. SKY65094-360LF Signal Descriptions

Pin	Name	Description	Pin	Name	Description
1	GND	Ground	5	N/U	Not used (may be grounded)
2	RF_IN	RF input	6	ENABLE	PA enable
3	N/U	Not used (may be grounded)	7	RF_OUT/BIAS	RF output/bias voltage
4	N/U	Not used (may be grounded)	8	N/U	Not used (may be grounded)

Technical Description

The SKY65094-360LF is a single stage, low-noise PA that operates with a single 5 V power supply connected through an RF choke (inductor L1) to the output signal (pin 7). The bias current is set by the on-chip active bias composed of current mirror and reference voltage transistors, which allow excellent gain tracking over temperature and voltage variations. The device is externally RF matched using surface-mount components to facilitate operation over a frequency range of 824 to 849 MHz.

Electrical and Mechanical Specifications

The absolute maximum ratings of the SKY65094-360LF are provided in Table 2. The recommended operating conditions are specified in Table 3 and electrical specifications are provided in Table 4 (general specifications), Table 5 (698 to 716 MHz), Table 6 (777 to 798 MHz), Table 7 (824 to 849 MHz), and Table 8 (880 to 915 MHz).

Typical performance characteristics of the SKY65094-360LF for the 824 to 849 MHz frequency range are illustrated in Figures 3 through 10.

Table 2. SKY65094-360LF Absolute Maximum Ratings¹

Parameter	Symbol	Minimum	Maximum	Units
Supply voltage	V _{CC}	-0.3	+6.0	V
RF input power	P _{IN}		+20	dBm
Supply current @ P1dB	I _{CC}		400	mA
Power dissipation @ P1dB	P _D		1.1	W
Power dissipation @ P _{IN} = -10 dBm	P _D		0.7	W
Operating case temperature	T _C	0	+95	°C
Extended operating temperature	T _{EXT}	-33	+95	°C
Storage temperature	T _{ST}	-55	+150	°C
Junction temperature	T _J		+150	°C
Thermal resistance	Θ _{JC}		35	°C/W

¹ Exposure to maximum rating conditions for extended periods may reduce device reliability. There is no damage to device with only one parameter set at the limit and all other parameters set at or below their nominal values. Exceeding any of the limits listed here may result in permanent damage to the device.

ESD HANDLING: *Although this device is designed to be as robust as possible, electrostatic discharge (ESD) can damage this device. This device must be protected at all times from ESD when handling or transporting. Static charges may easily produce potentials of several kilovolts on the human body or equipment, which can discharge without detection. Industry-standard ESD handling precautions should be used at all times.*

Table 3. SKY65094-360LF Recommended Operating Conditions

Parameter	Symbol	Min	Typ	Max	Units
Bias voltage	V _{CC}	4.75	5.00	5.25	V
Enable voltage	V _{EN}		3.3		V
Operating frequency	f	698		915	MHz

Table 4. SKY65094-360LF Electrical Characteristics: General

Parameter	Symbol	Test Conditions	Min	Typ	Max	Units
Quiescent current	I _{CO}	No RF		130	145	mA
Gain vs temperature			-0.01		+0.01	dB/°C
0.1 dB output compression point	OPO.1dB	Sweep input power	+19			dBm
Turn-on time		P _{IN} = -10 dBm, V _{EN} = 3.3 V		1		μs
Stability		P _{IN} = 0 dBm, over all operating temperatures	Unconditional			-

Table 5. SKY65094-360LF Electrical Characteristics: 698 to 716 MHz¹

(V_{CC} = +5 V, T_c = 25 °C, CW, Unless Otherwise Noted)

Parameter	Symbol	Test Conditions	Min	Typ	Max	Units
Frequency	f		698		716	MHz
Third order input intercept point	IIP3	P _{IN} = -10 dBm/tone, 5 MHz spacing		+26.5		dBm
Small signal gain	IS21I	P _{IN} = -30 dBm		16.5		dB
Input return loss	IS11I	P _{IN} = -30 dBm		21		dB
Output return loss	IS22I	P _{IN} = -30 dBm		6.8		dB
Noise figure	NF			3.3		dB
1 dB output compression point	OP1dB	Sweep input power		+22.7		dBm

¹ Performance is verified by characterization. Evaluation Board input trace loss up to DC blocking capacitor = 0.06 dB. Output trace loss up to DC blocking capacitor = 0.07 dB.

Table 6. SKY65094-360LF Electrical Characteristics: 777 to 798 MHz¹
(V_{CC} = +5 V, T_c = 25 °C, CW, Unless Otherwise Noted)

Parameter	Symbol	Test Conditions	Min	Typ	Max	Units
Frequency	f		777		798	MHz
Third order input intercept point	IIP3	P _{IN} = -10 dBm/tone, 5 MHz spacing		+28.8		dBm
Small signal gain	IS21I	P _{IN} = -30 dBm		17.0		dB
Input return loss	IS11I	P _{IN} = -30 dBm		21.5		dB
Output return loss	IS22I	P _{IN} = -30 dBm		10		dB
Noise figure	NF			3.0		dB
1 dB output compression point	OP1dB	Sweep input power		+23.2		dBm

¹ Performance is verified by characterization. Evaluation Board input trace loss up to DC blocking capacitor = 0.08 dB. Output trace loss up to DC blocking capacitor = 0.10 dB.

Table 7. SKY65094-360LF Electrical Characteristics: 824 to 849 MHz, Tested to Production Screen Limits¹
(V_{CC} = +5 V, V_{EN} = 3.3 V, T_c = 25 °C, CW, Unless Otherwise Noted)

Parameter	Symbol	Test Conditions	Min	Typ	Max	Units
Frequency	f		824		849	MHz
Third order input intercept point	IIP3	P _{IN} = -10 dBm/tone, 5 MHz spacing	+27.5	+29.5		dBm
Small signal gain	IS21I	P _{IN} = -30 dBm	16	17	18	dB
Gain vs frequency			-0.25	+0.12	+0.25	dB/20 MHz
Input return loss	IS11I	P _{IN} = -30 dBm	15	23		dB
Output return loss	IS22I	P _{IN} = -30 dBm	10	15		dB
Noise figure	NF			3.2	4.0	dB
1 dB output compression point	OP1dB	Sweep input power	+24.5	+25.5		dBm

¹ Performance is guaranteed only under the conditions listed in this table, and corresponds to the Bill of Materials in Table 8 for this frequency band. Evaluation Board input trace loss up to DC blocking capacitor = 0.09 dB. Output trace loss up to DC blocking capacitor = 0.10 dB.

Table 8. SKY65094-360LF Electrical Characteristics: 880 to 915 MHz¹
(V_{CC} = +5 V, T_c = 25 °C, CW, Unless Otherwise Noted)

Parameter	Symbol	Test Conditions	Min	Typ	Max	Units
Frequency	f		880		915	MHz
Third order input intercept point	IIP3	P _{IN} = -10 dBm/tone, 5 MHz spacing		+30		dBm
Small signal gain	IS21I	P _{IN} = -30 dBm		16.8		dB
Input return loss	IS11I	P _{IN} = -30 dBm		20		dB
Output return loss	IS22I	P _{IN} = -30 dBm		14		dB
Noise figure	NF			3.0		dB
1 dB output compression point	OP1dB	Sweep input power		+25.5		dBm

¹ Performance is verified by characterization. Evaluation Board input trace loss up to DC blocking capacitor = 0.09 dB. Output trace loss up to DC blocking capacitor = 0.10 dB.

**Typical Performance Characteristics (824 to 849 MHz)
(Based on BOM in Table 9)**

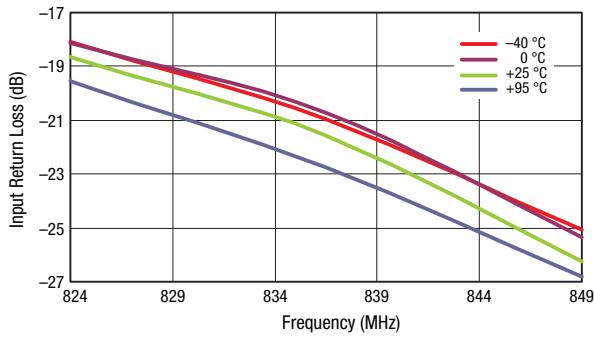

Figure 3. Input Return Loss vs Frequency Over Temperature

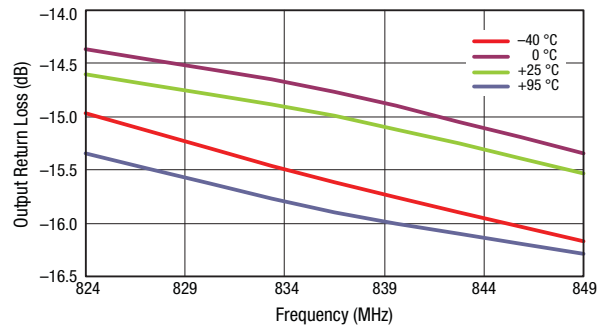

Figure 4. Output Return Loss vs Frequency Over Temperature

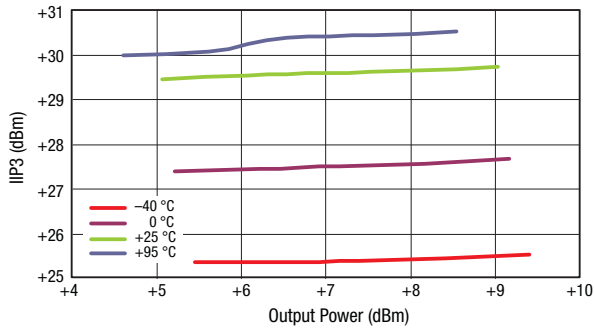

Figure 5. IIP3 vs Output Power Over Temperature

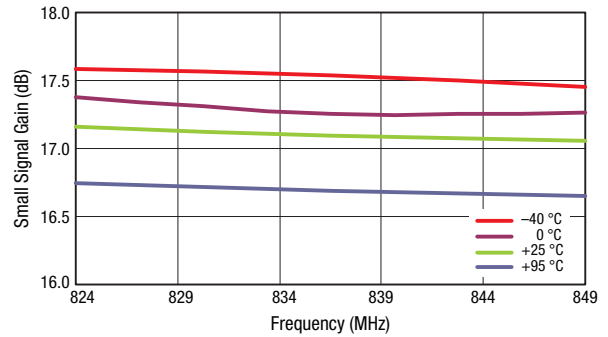

Figure 6. Small Signal Gain vs Frequency Over Temperature

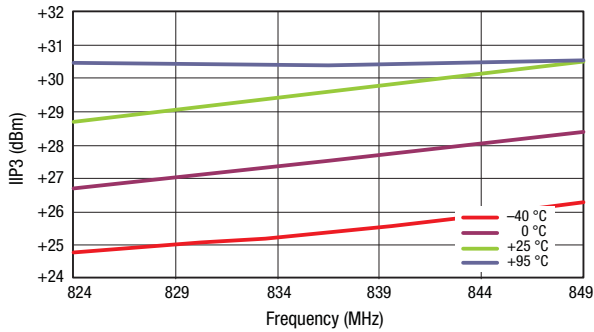

Figure 7. IIP3 vs Frequency Over Temperature

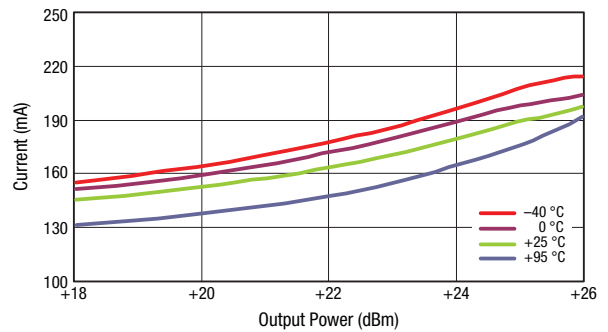

Figure 8. Current vs Output Power Over Temperature

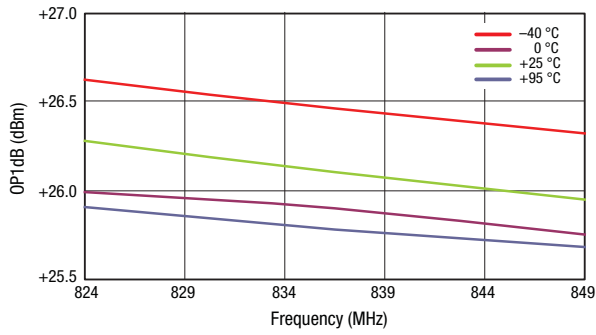

Figure 9. OP1dB vs Frequency Over Temperature

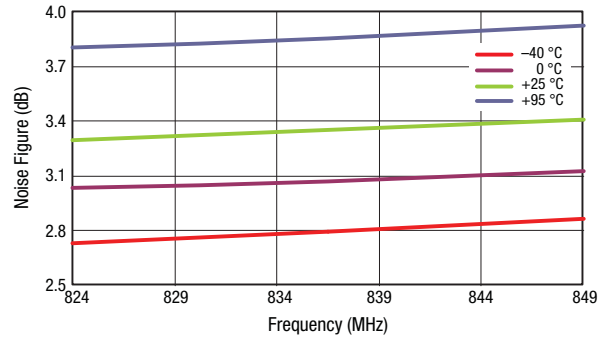

Figure 10. Noise Figure vs Frequency Over Temperature

Evaluation Board Description

The Skyworks SKY65094-360LF Evaluation Board is used to test the performance of the SKY65094-360LF PA driver. An assembly drawing for the Evaluation Board is shown in Figure 1,1 and the layer detail is provided in Figure 12. The layer detail physical characteristics are noted in Figure 13.

Capacitor C10 provides DC bias decoupling for the output stage collector voltage. Pins 2 and 7 are the RF input and output signals, respectively. External DC blocking is required on the input and output, but can be implemented as part of the RF matching circuit. Pin 1 (GND) and the center ground pad provide the DC and RF ground.

Testing Procedure

Use the following procedure to set up the SKY65094-360LF Evaluation Board for testing:

1. Connect a 5.0 V supply to the VCC pin and 3.3 V to the ENABLE pin of the J3 header (see Evaluation Board assembly drawing in Figure 11 and schematic diagram in Figure 14). If available, enable the current limiting function of the power supply to 500 mA.
2. Connect a signal generator to the RF signal input port. Set it to the desired RF frequency at a power level of -15 dBm or less to the Evaluation Board but do NOT enable the RF signal.
3. Connect a spectrum analyzer to the RF signal output port.
4. Enable the power supply.
5. Enable the RF signal.
6. Take measurements.

CAUTION: *If any of the output signals exceed the rated maximum values, the SKY65094-360LF Evaluation Board can be permanently damaged.*

Circuit Design Configurations

The following design considerations are general in nature and must be followed regardless of final use or configuration.

1. Paths to ground should be made as short as possible.
2. The ground pad of the SKY65094-360LF power amplifier has special electrical and thermal grounding requirements. This pad is the main thermal conduit for heat dissipation. Since the circuit board acts as the heat sink, it must shunt as much heat as possible from the amplifier. As such, design the connection to the ground pad to dissipate the maximum wattage produced to the circuit board. Multiple vias to the grounding layer are required.

NOTE: *Junction temperature (T_j) of the device increases with a poor connection to the slug and ground. This reduces the lifetime of the device.*

A suggested matching circuit is shown in Figure 14 with component values for the SKY65094-360LF Evaluation Board listed in Table 9.

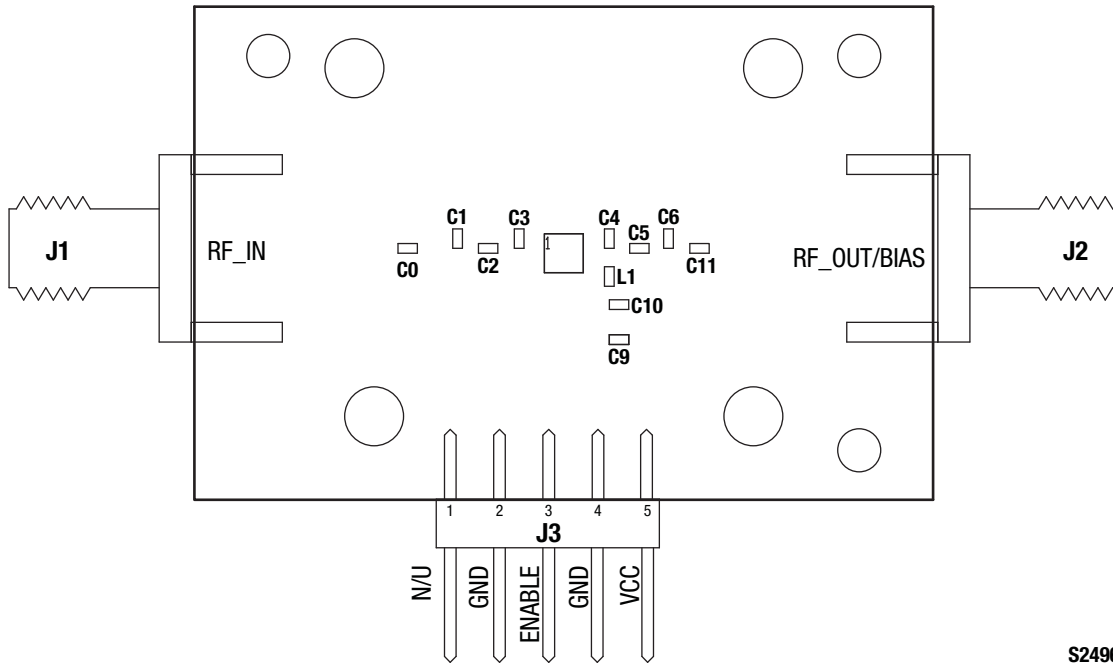

S2496

Figure 11. Evaluation Board Assembly Drawing

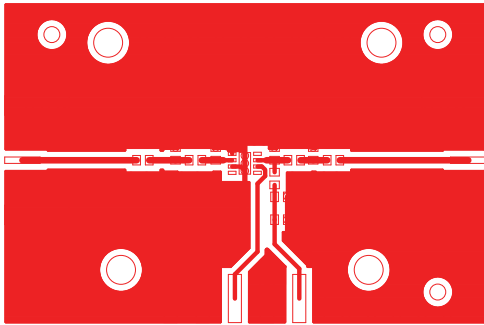

Layer 1: Top – Metal

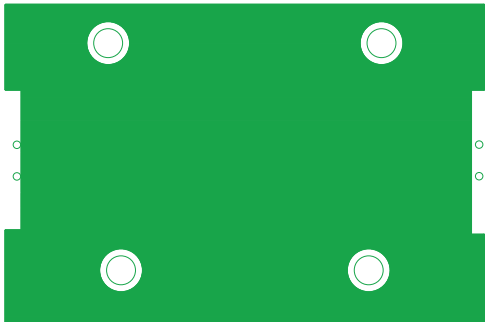

Layer 2: Ground

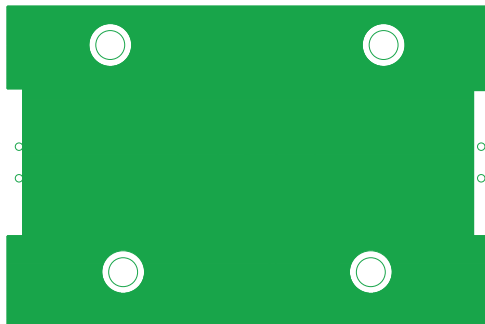

Layer 3: Power Plane

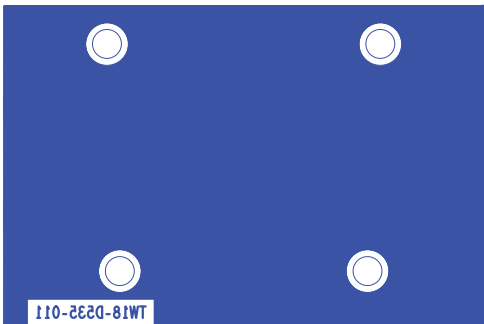

Layer 4: Solid Ground Plane

S2497

Figure 12. Evaluation Board Layer Detail

Cross Section	Name	Thickness (mm)	Material
	Tmask	0.010	Solder Resist
	L1	0.035	Cu, 1 oz.
	Dielectric	0.250	FR4
	L2	0.035	Cu, 1 oz
	Dielectric	1.000	FR4
	L3	0.035	Cu, 1 oz
	Dielectric	0.250	FR4
	L4	0.035	Cu, 1 oz
	Bmask	0.010	Solder resist

201861-013

Figure 13. Layer Detail Physical Characteristics

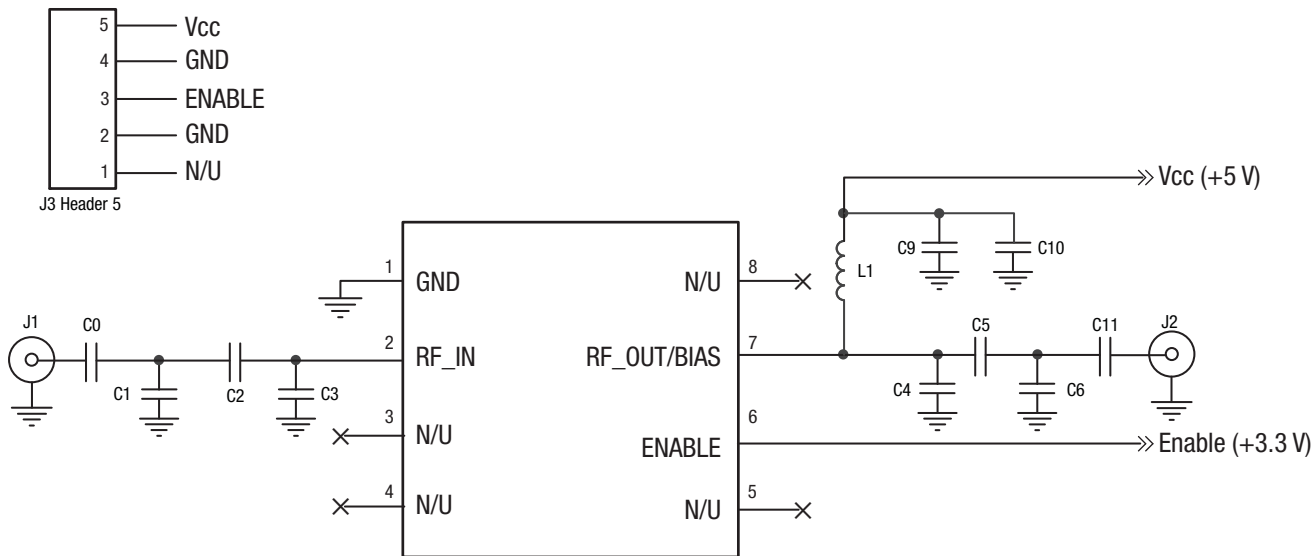

S2495A

Figure 14. SKY65094-360LF Evaluation Board Schematic

Table 9. SKY65094-360LF (DFN Package) Evaluation Board Bill of Materials (1 of 2)

Component	Size	Value	Vendor	Vendor Part #
698 MHz to 716 MHz				
C0	0402	33 pF	Murata	GRM1555C1H330JZ01
C1	0402	4.7 nH	Murata	LQG15HS4N7S02
C2	0402	7.5 pF	Murata	GRM1555C1H7R5CB01
C3	0402	DNI	-	-
C4	0402	DNI	-	-
C5	0402	3.3 pF	Murata	GJM1555C1H3R3BB01B
C6	0402	12 nH	Murata	LQG15HS12NJ02
C9	1206	DNI	-	-
C10	0402	1 μ F	Murata	GRM155R61A105KE15
C11	0402	33 pF	Murata	GRM1555C1H330JZ01
J1, J2		SMA Connector		615R54-021
J3		Connector, 5-pin header		615R31-040
L1	0402	18 nH	Murata	LQG15HS18NJ02
777 MHz to 798 MHz				
C0	0402	33 pF	Murata	GRM1555C1H330JZ01
C1	0402	4.3 nH	Murata	LQG15HS4N3S02
C2	0402	7 pF	Murata	GRM615C0G070C50
C3	0402	DNI	-	-
C4	0402	DNI	-	-
C5	0402	4.7 pF	Murata	GJM1555C1H4R7BB01
C6	0402	12 nH	Murata	LQG15HS12NJ02
C9	1206	DNI	-	-
C10	0402	1 μ F	Murata	GRM155R61A105KE15
C11	0402	33 pF	Murata	GRM1555C1H330JZ01
J1, J2		SMA Connector		615R54-021
J3		Connector, 5-pin header		615R31-040
L1	0402	18 nH	Murata	LQG15HS18NJ02

Table 9. SKY65094-360LF (DFN Package) Evaluation Board Bill of Materials (2 of 2)

Component	Size	Value	Vendor	Vendor Part #
824 MHz to 849 MHz				
C0	0402	33 pF	Murata	GRM1555C1H330JZ01
C1	0402	5.1 nH	Murata	LQG15HS5N1S02
C2	0402	6 pF	Murata	GJM1555C1H6R0BB01
C3	0402	DNI	-	-
C4	0402	DNI	-	-
C5	0402	8.2 pF	Murata	GJM1555C1H8R2CB01
C6	0402	12 nH	Murata	LQG15HS12NJ02
C9	1206	DNI	-	-
C10	0402	1 μF	Murata	GRM155R61A105KE15
C11	0402	33 pF	Murata	GRM1555C1H330JZ01
J1, J2		SMA Connector		615R54-021
J3		Connector, 5-pin header		615R31-040
L1	0402	18 nH	Murata	LQG15HS18NJ02
880 MHz to 915 MHz				
C0	0402	33 pF	Murata	GRM1555C1H330JZ01
C1	0402	4.7 nH	Murata	LQG15HS4N7S02
C2	0402	5.6 pF	Murata	GJM1555C1H5R6CB01
C3	0402	DNI	-	-
C4	0402	DNI	-	-
C5	0402	8.2 pF	Murata	GJM1555C1H8R2CB01
C6	0402	10 nH	Murata	LQG15H10NJ02
C9	1206	DNI	-	-
C10	0402	1 μF	Murata	GRM155R61A105KE15
C11	0402	33 pF	Murata	GRM1555C1H330JZ01
J1, J2		SMA Connector		615R54-021
J3		Connector, 5-pin header		615R31-040
L1	0402	18 nH	Murata	LQG15HS18NJ02

Package Dimensions

The PCB layout footprint for the SKY65094-360LF is shown in Figure 15. Typical part markings are shown in Figure 16. Package dimensions are shown in Figure 17, and tape and reel dimensions are provided in Figure 18.

Package and Handling Information

Instructions on the shipping container label regarding exposure to moisture after the container seal is broken must be followed. Otherwise, problems related to moisture absorption may occur when the part is subjected to high temperature during solder assembly.

The SKY65094-360LF is rated to Moisture Sensitivity Level 1 (MSL1) at 260 °C. It can be used for lead or lead-free soldering.

Care must be taken when attaching this product, whether it is done manually or in a production solder reflow environment. Production quantities of this product are shipped in a standard tape and reel format.

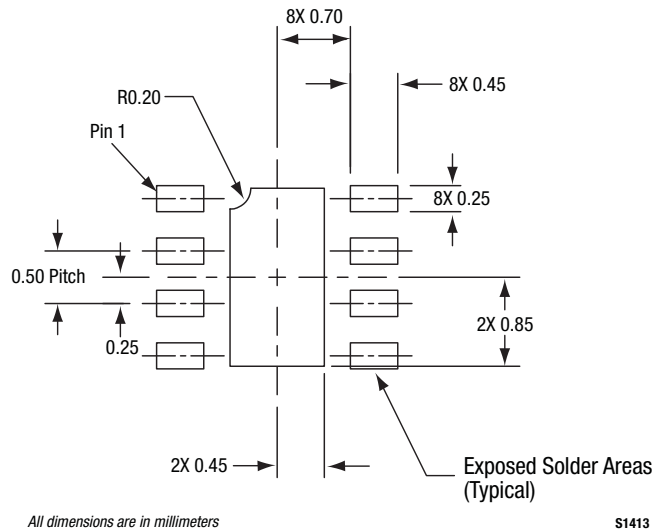

Figure 15. SKY65094-360LF PCB Layout Footprint

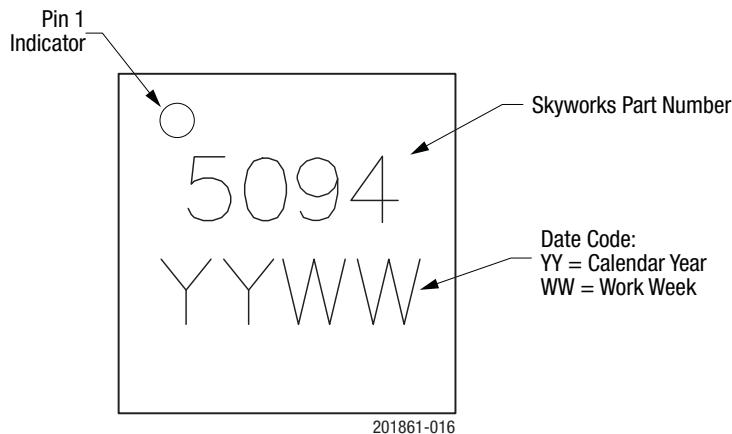
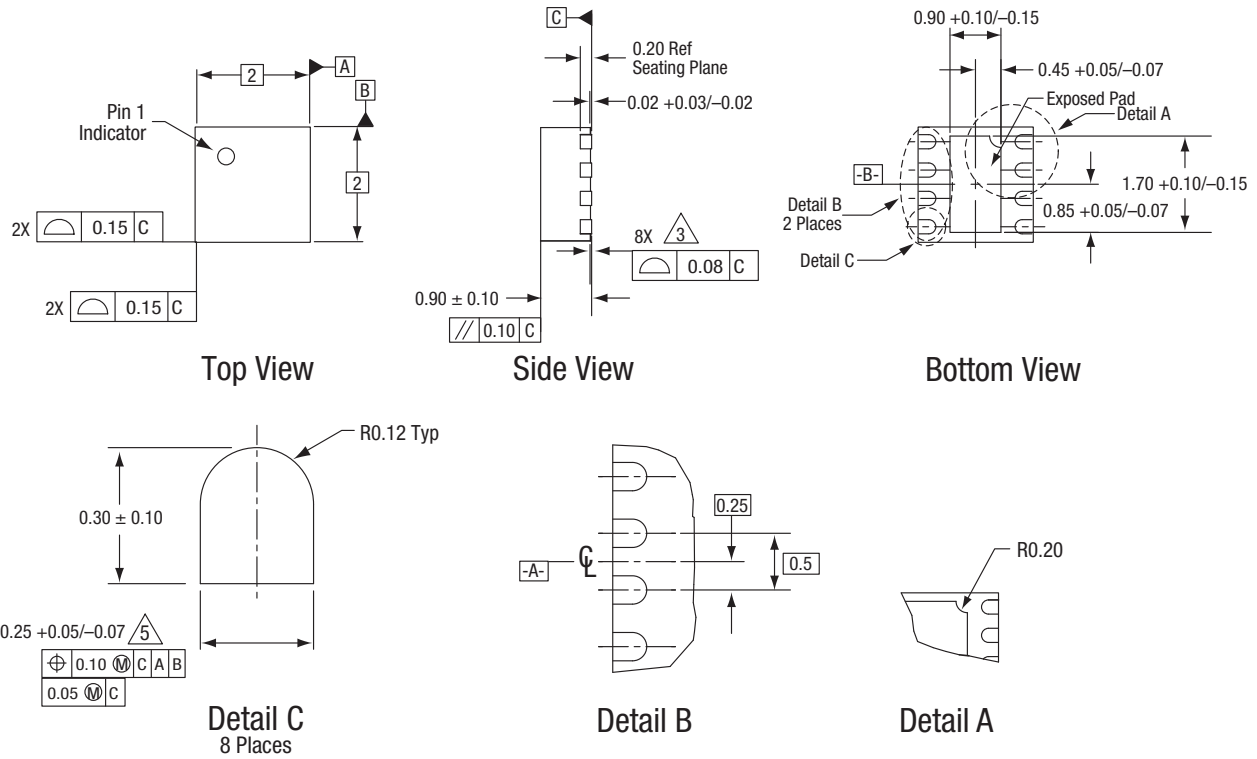

Figure 16. Typical Part Markings (Top View)



All measurements are in millimeters.
 Dimensioning and tolerancing according to ASME Y14.5M-1994.
 Coplanarity applies to the exposed heat sink slug as well as the terminals.
 Plating requirement per source control drawing (SCD) 2504.
 Dimension applies to metalized terminal and is measured between 0.15 mm and 0.30 mm from terminal tip.

201861-017

Figure 17. SKY65094-360LF Package Dimensions

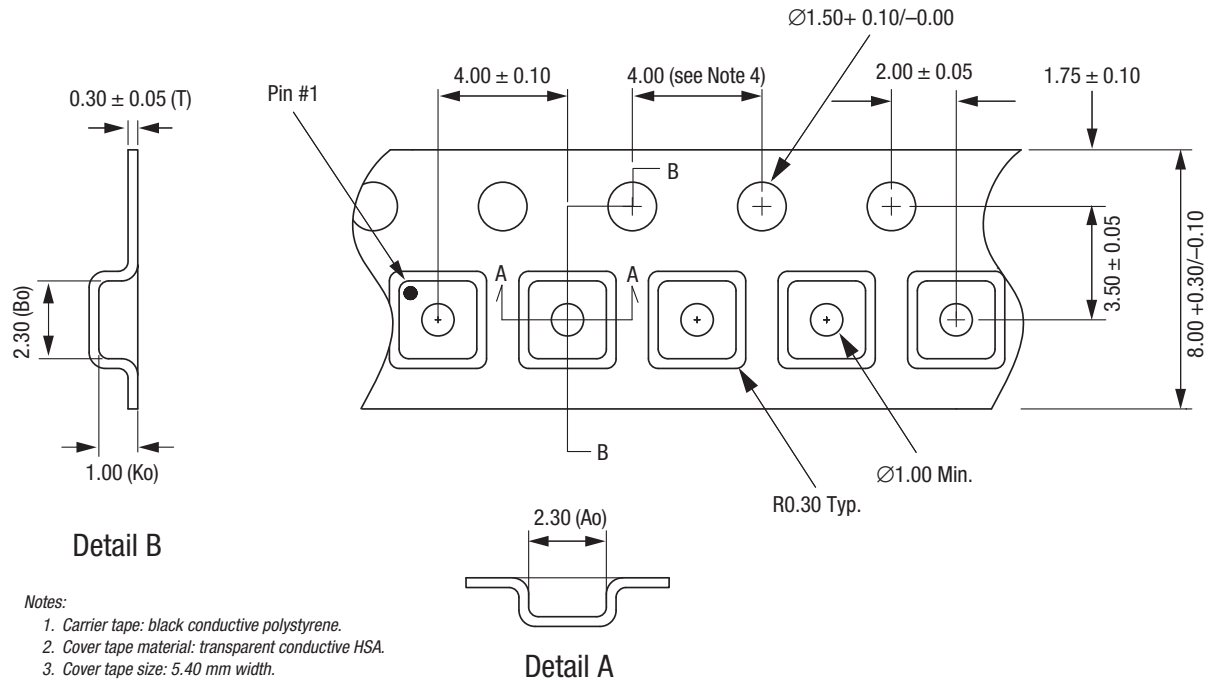

Notes:

1. Carrier tape: black conductive polystyrene.
2. Cover tape material: transparent conductive HSA.
3. Cover tape size: 5.40 mm width.
4. Ten sprocket hole pitch cumulative tolerance = ± 0.20 mm.
5. ESD surface resistivity is $\leq 1 \times 10^9$ Ohms/square per EIA, JEDEC tape and reel specification.
6. Ao and Bo measurement point to be 0.30 mm from bottom pocket.
7. All measurements are in millimeters.

201861-018

Figure 18. SKY65094-360LF Tape and Reel Dimensions

Ordering Information

Model Name	Ordering Part Number	Evaluation Board Part Number
SKY65094-360LF Low-Noise PA Driver	SKY65094-360LF	SKY65094-360EK1 (698 to 716MHz) SKY65094-360EK2 (777 to 798MHz) SKY65094-360EK3 (824 to 849MHz) SKY65094-360EK4 (880 to 915MHz)

Copyright © 2012, 2017 Skyworks Solutions, Inc. All Rights Reserved.

Information in this document is provided in connection with Skyworks Solutions, Inc. (“Skyworks”) products or services. These materials, including the information contained herein, are provided by Skyworks as a service to its customers and may be used for informational purposes only by the customer. Skyworks assumes no responsibility for errors or omissions in these materials or the information contained herein. Skyworks may change its documentation, products, services, specifications or product descriptions at any time, without notice. Skyworks makes no commitment to update the materials or information and shall have no responsibility whatsoever for conflicts, incompatibilities, or other difficulties arising from any future changes.

No license, whether express, implied, by estoppel or otherwise, is granted to any intellectual property rights by this document. Skyworks assumes no liability for any materials, products or information provided hereunder, including the sale, distribution, reproduction or use of Skyworks products, information or materials, except as may be provided in Skyworks Terms and Conditions of Sale.

THE MATERIALS, PRODUCTS AND INFORMATION ARE PROVIDED “AS IS” WITHOUT WARRANTY OF ANY KIND, WHETHER EXPRESS, IMPLIED, STATUTORY, OR OTHERWISE, INCLUDING FITNESS FOR A PARTICULAR PURPOSE OR USE, MERCHANTABILITY, PERFORMANCE, QUALITY OR NON-INFRINGEMENT OF ANY INTELLECTUAL PROPERTY RIGHT; ALL SUCH WARRANTIES ARE HEREBY EXPRESSLY DISCLAIMED. SKYWORKS DOES NOT WARRANT THE ACCURACY OR COMPLETENESS OF THE INFORMATION, TEXT, GRAPHICS OR OTHER ITEMS CONTAINED WITHIN THESE MATERIALS. SKYWORKS SHALL NOT BE LIABLE FOR ANY DAMAGES, INCLUDING BUT NOT LIMITED TO ANY SPECIAL, INDIRECT, INCIDENTAL, STATUTORY, OR CONSEQUENTIAL DAMAGES, INCLUDING WITHOUT LIMITATION, LOST REVENUES OR LOST PROFITS THAT MAY RESULT FROM THE USE OF THE MATERIALS OR INFORMATION, WHETHER OR NOT THE RECIPIENT OF MATERIALS HAS BEEN ADVISED OF THE POSSIBILITY OF SUCH DAMAGE.

Skyworks products are not intended for use in medical, lifesaving or life-sustaining applications, or other equipment in which the failure of the Skyworks products could lead to personal injury, death, physical or environmental damage. Skyworks customers using or selling Skyworks products for use in such applications do so at their own risk and agree to fully indemnify Skyworks for any damages resulting from such improper use or sale.

Customers are responsible for their products and applications using Skyworks products, which may deviate from published specifications as a result of design defects, errors, or operation of products outside of published parameters or design specifications. Customers should include design and operating safeguards to minimize these and other risks. Skyworks assumes no liability for applications assistance, customer product design, or damage to any equipment resulting from the use of Skyworks products outside of stated published specifications or parameters.

Skyworks and the Skyworks symbol are trademarks or registered trademarks of Skyworks Solutions, Inc., in the United States and other countries. Third-party brands and names are for identification purposes only, and are the property of their respective owners. Additional information, including relevant terms and conditions, posted at www.skyworksinc.com, are incorporated by reference.