

SLC NAND FLASH and LPDDR2 162-Ball MCP (Multi-Chip Package)

Key Features

NAND Flash Features:

- *Low Power Dissipation*
- *High Reliability*

Contents

1. MCP FEATURES	3
2. BLOCK DIAGRAM.....	4
3. PART NAME DESCRIPTION.....	5
4. PRODUCT SELECTION GUIDE.....	6
5. PIN CONFIGURATIONS	7
162-Ball, BGA (NAND x16; LPDDR x32).....	7
162-Ball, BGA (NAND x8; LPDDR x32).....	8
162-Ball, BGA (NAND x8; LPDDR x16).....	9
162-Ball, BGA (NAND x16; LPDDR x16).....	10
6. PIN DESCRIPTION	11
LPDDR2 x32.....	11
LPDDR2 x16.....	12
7. PACKAGE INFORMATION.....	13
8. REVISION HISTORY	14

1. MCP FEATURES

Operation Temperature

- 30°C to +85°C
- 40°C to +85°C

Package

- 162-ball FBGA - 8.0mmx10.5mm, 1.0mm (h) (max), 0.5mm pitch

NAND Flash Features

- **1G-bit/2G-bit/4G-bit SLC NAND Flash**

- Bus: x8 / x16
- 8 bit-ECC SLC NAND Flash:
 - Page size: (2048+112) byte for x8 bus, (1024+56) word for x16 bus
 - Block size: (128K+7K) byte for x8 bus, (64K+2K) word for x16 bus
- 4 bit-ECC SLC NAND Flash:
 - Page size: (2048+64) byte for x8 bus, (1024+32) word for x16 bus
 - Block size: (128K+4K) byte for x8 bus, (64K+2K) word for x16 bus
- Plane size:
 - 1024-block/plane x 1 for 1Gb
 - 1024-block/plane x 2 for 2Gb
 - 2048-block/plane x 2 for 4Gb

- **ONFI 1.0 compliant**

- **User Redundancy**

- 8 bit-ECC SLC NAND Flash:
 - 112-byte attached to each page
- 4 bit-ECC SLC NAND Flash:
 - 64-byte attached to each page

- **Fast Read Access**

- Latency of array to register: 25us
- Sequential read: 25ns

- **Cache Read Support**

- **Page Program Operation**

- Page program time: 320us (typ.)

- **Cache Program Support**

- **Block Erase Operation**

- Block erase time: 1.0ms (typ.)

- **Single Voltage Operation:**

- VCC: 1.7-1.95V

- **Low Power Dissipation**

- Max. 30mA (1.8V)
- Active current (Read/Program/Erase)

- **Sleep Mode**

- 50uA (Max) standby current

- **Unique ID Read support (ONFI)**

- **Secure OTP support**

- **Electronic Signature (5 Cycles)**

- **High Reliability**

- 8 bit-ECC SLC NAND Flash:
 - Endurance: typical 100K cycles (with 8-bit ECC per (512+28) Byte)
- 4 bit-ECC SLC NAND Flash:
 - Endurance: typical 100K cycles (with 4-bit ECC per (512+16) Byte)
- Data Retention: 10 years

LPDDR2 DRAM Features

- **JEDEC LPDDR2-S4B compliance**

- **DLL is not implemented**

- **Low power consumption**

- **Mobile RAM functions**

- Partial Array Self-Refresh (PASR)
- Auto Temperature Compensated Self-Refresh (ATCSR) by built-in temperature sensor
- Deep power-down mode
- Per Bank Refresh

- **VDD Definition:**

	Typical	Range
VDD1	1.8V	1.7-1.95V
VDD2	1.2V	1.14-1.3V
VDDQ	1.2V	1.14-1.3V

- Voltage source of VREFCA is VDD2, VREFCA=1/2*VDD2 (from voltage divider)

- Voltage source of VREFDQ is VDDQ, VREFDQ=1/2*VDDQ (from voltage divider)

	Min.	Max.
VREFCA	0.49xVDD2	0.51xVDD2
VREFDQ	0.49xVDDQ	0.51xVDDQ

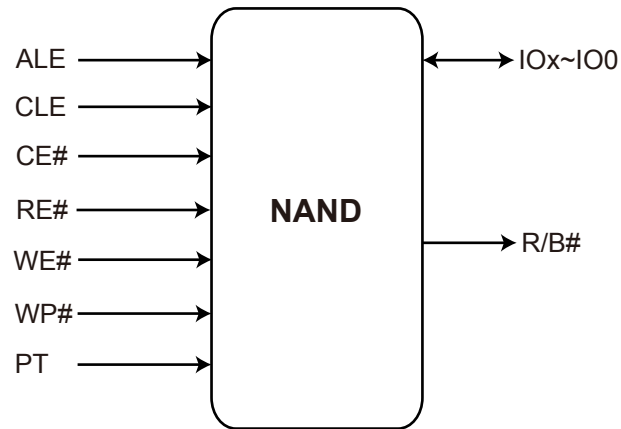
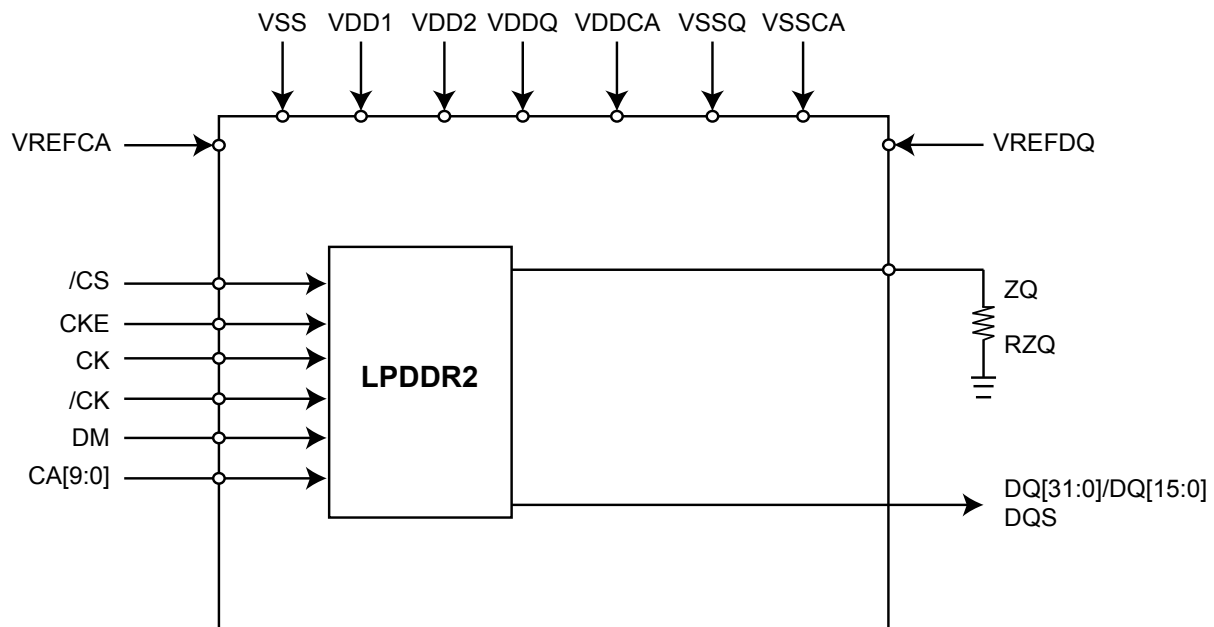
2. BLOCK DIAGRAM**NAND****LPDDR2**

3. PART NAME DESCRIPTION

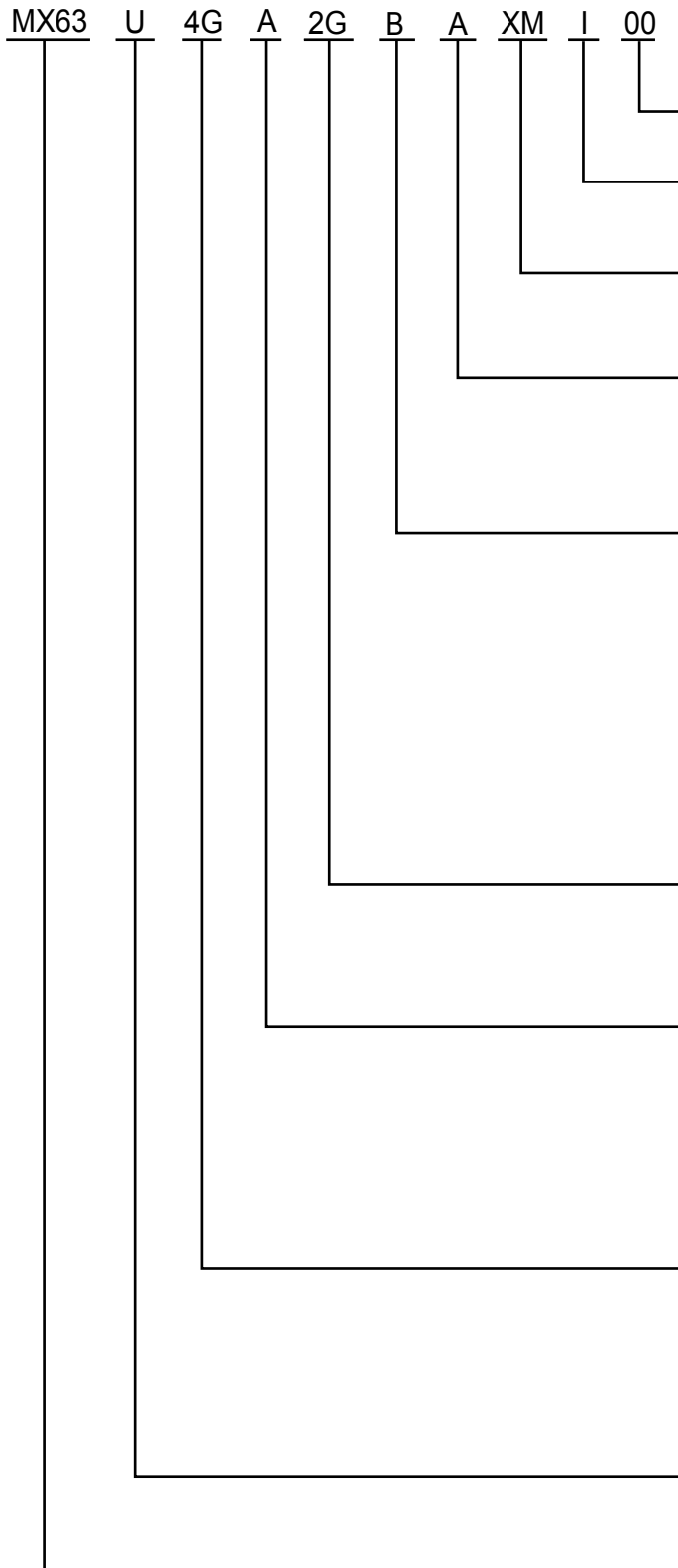

Option Code

00: -30°C to +85°C
01: -40°C to +85°C

Product Grade

I: Industrial

Package:

XM: 162-Ball FBGA

XN: 130-Ball FBGA

MCP Combinations

Type	CE#	Combination
A	1,1	1 NAND; 1 LPDDR

LPDDR Configuration

Type	Bus	Vcc	Generation	Speed
A	DDR2 x16	1.7-1.95V	3	533MHz
B	DDR2 x32	1.7-1.95V	2	533MHz
C	DDR2 x32	1.7-1.95V	3	533MHz
E	DDR x16	1.7-1.95V	5	200MHz
F	DDR x32	1.7-1.95V	5	200MHz
J	DDR x16	1.7-1.95V	5	200MHz
K	DDR x32	1.7-1.95V	5	200MHz
G	DDR2 x16	1.7-1.95V	6	533MHz
H	DDR2 x32	1.7-1.95V	6	533MHz

LPDDR Density

256M = 56 2G = 2G
512M = 12 4G = 4G
1G = 1G 8G = 8G

NAND Configuration

Type	Bus	Number of ECC-bit	Generation
A	x8	8	1st
B	x16	8	1st
C	x8	4	1st
D	x16	4	1st
E	x8	4	2nd

NAND Density

512M = 12 8G = 8G
1G = 1G 16G = AG
2G = 2G 32G = BG
4G = 4G 64G = CG

NAND Voltage: 1.8V

Product Family

MX63U : NAND + LPDRAM MCP

4. PRODUCT SELECTION GUIDE

Please contact Macronix regional sales for the latest product selection and available form factors.

Item No.	Device	NAND Flash	Mobile DRAM	Package Type	VDDCA Pin
1.	MX63U4GA2GBAXMI00	4Gb, x8, 1.8V, 8-bit ECC	2Gb, LPDDR2, x32, 1.8V	162 Ball BGA	
2.	MX63U4GC2GBAXMI00	4Gb, x8, 1.8V, 4-bit ECC	2Gb, LPDDR2, x32, 1.8V	162 Ball BGA	
3.	MX63U2GA1GCAXMI00	2Gb, x8, 1.8V, 8-bit ECC	1Gb, LPDDR2, x32, 1.8V	162 Ball BGA	
4.	MX63U2GB1GCAXMI00	2Gb, x16, 1.8V, 8-bit ECC	1Gb, LPDDR2, x32, 1.8V	162 Ball BGA	
5.	MX63U2GC1GCAXMI00	2Gb, x8, 1.8V, 4-bit ECC	1Gb, LPDDR2, x32, 1.8V	162 Ball BGA	
6.	MX63U2GC1GCAXMI01	2Gb, x8, 1.8V, 4-bit ECC	1Gb, LPDDR2, x32, 1.8V	162 Ball BGA	
7.	MX63U2GD1GCAXMI01	2Gb, x16, 1.8V, 4-bit ECC	1Gb, LPDDR2, x32, 1.8V	162 Ball BGA	
8.	MX63U1GC1GAAXMI00	1Gb, x8, 1.8V, 4-bit ECC	1Gb, LPDDR2, x16, 1.8V	162 Ball BGA	
9.	MX63U1GD1GAAXMI00	1Gb, x16, 1.8V, 4-bit ECC	1Gb, LPDDR2, x16, 1.8V	162 Ball BGA	
10.	MX63U1GC1GCAXMI01	1Gb, x8, 1.8V, 4-bit ECC	1Gb, LPDDR2, x32 1.8V	162 Ball BGA	
11.	MX63U1GC1GAAXMI01	1Gb, x8, 1.8V, 4-bit ECC	1Gb, LPDDR2, x16, 1.8V	162 Ball BGA	
12.	MX63U4GC2GGAXMI00	4Gb, x8, 1.8V, 4-bit ECC	2Gb, LPDDR2, x16, 1.8V	162 Ball BGA	Yes
13.	MX63U4GC2GGAXMI01	4Gb, x8, 1.8V, 4-bit ECC	2Gb, LPDDR2, x16, 1.8V	162 Ball BGA	Yes
14.	MX63U4GC2GHAXMI00	4Gb, x8, 1.8V, 4-bit ECC	2Gb, LPDDR2, x32, 1.8V	162 Ball BGA	Yes
15.	MX63U4GC2GHAXMI01	4Gb, x8, 1.8V, 4-bit ECC	2Gb, LPDDR2, x32, 1.8V	162 Ball BGA	Yes
16.	MX63U4GA2GHAXMI00	4Gb, x8, 1.8V, 8bit ECC	2Gb, LPDDR2, x32, 1.8V	162 Ball BGA	Yes
17.	MX63U2GE2GGAXMI00	2Gb, x8, 1.8V, 4-bit ECC	2Gb, LPDDR2, x16, 1.8V	162 Ball BGA	Yes
18.	MX63U2GE2GGAXMI01	2Gb, x8, 1.8V, 4-bit ECC	2Gb, LPDDR2, x16, 1.8V	162 Ball BGA	Yes
19.	MX63U2GE2GHAXMI00	2Gb, x8, 1.8V, 4-bit ECC	2Gb, LPDDR2, x32, 1.8V	162 Ball BGA	Yes
20.	MX63U2GE2GHAXMI01	2Gb, x8, 1.8V, 4-bit ECC	2Gb, LPDDR2, x32, 1.8V	162 Ball BGA	Yes
21.	MX63U1GC12HAXMI01	1Gb, x8, 1.8V, 4-bit ECC	512Mb, LPDDR2, x32, 1.8V	162 Ball BGA	

5. PIN CONFIGURATIONS

162-Ball, BGA (NAND x16; LPDDR x32)

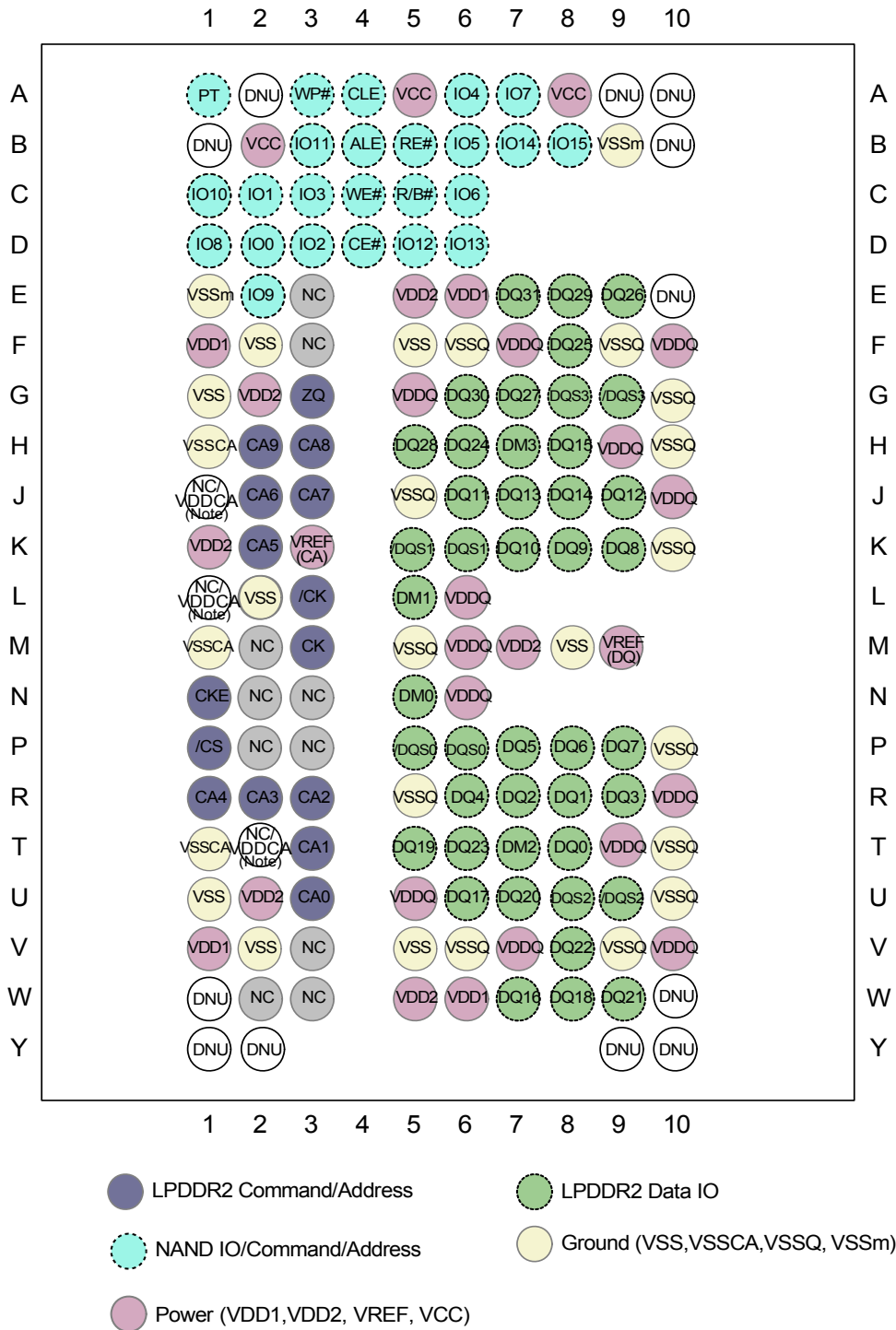

Note: Please check Product Selection Guide for NC pin or VDDCA pin support.

162-Ball, BGA (NAND x8; LPDDR x32)

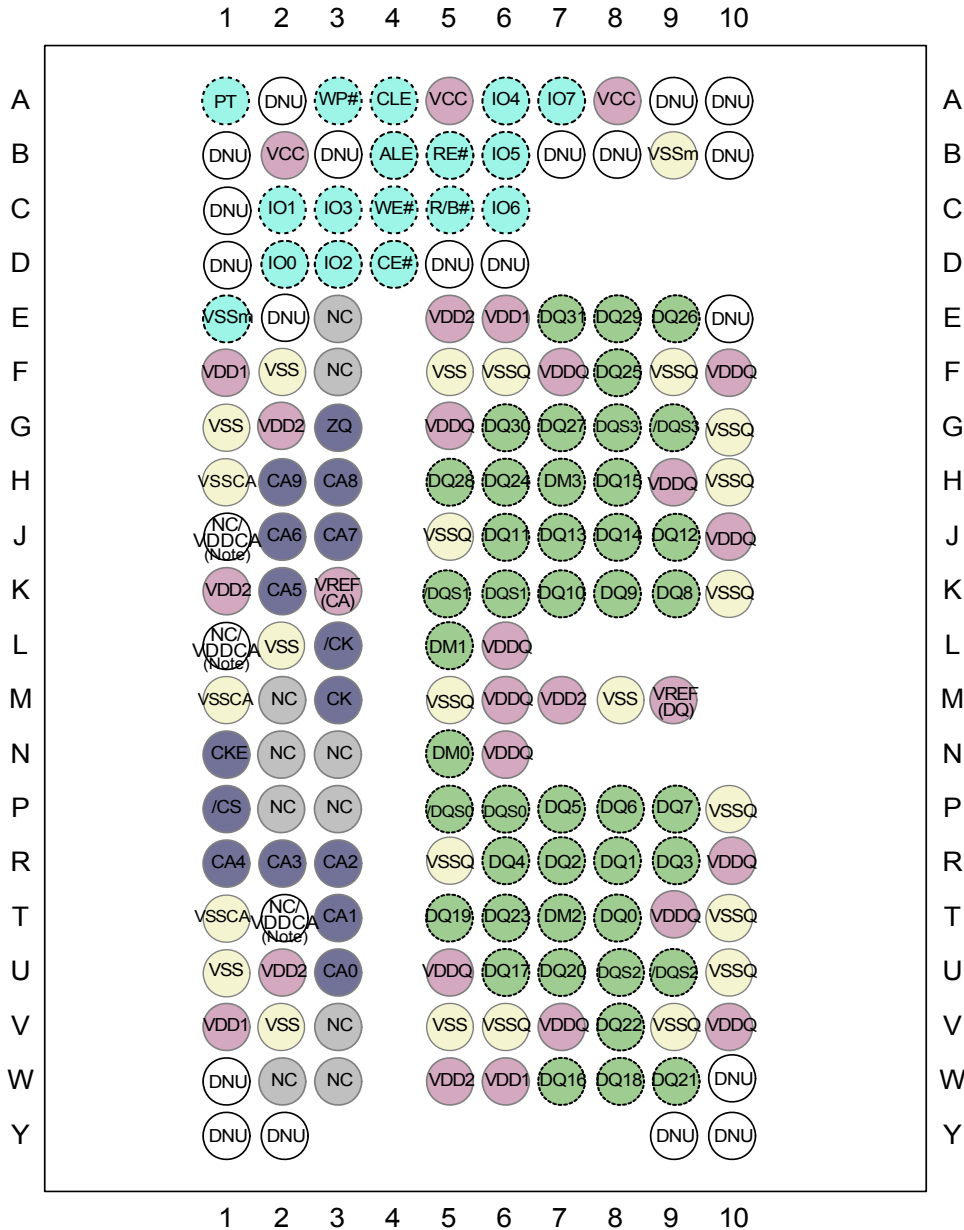

- LPDDR2 Command/Address
- LPDDR2 Data IO
- NAND IO/Command/Address
(NAND DNU pin must keep floating)
- Ground (VSS, VSSCA, VSSQ, VSSm)
- Power (VDD1, VDD2, VREF, VCC)

Note: Please check Product Selection Guide for NC pin or VDDCA pin support.

162-Ball, BGA (NAND x8; LPDDR x16)

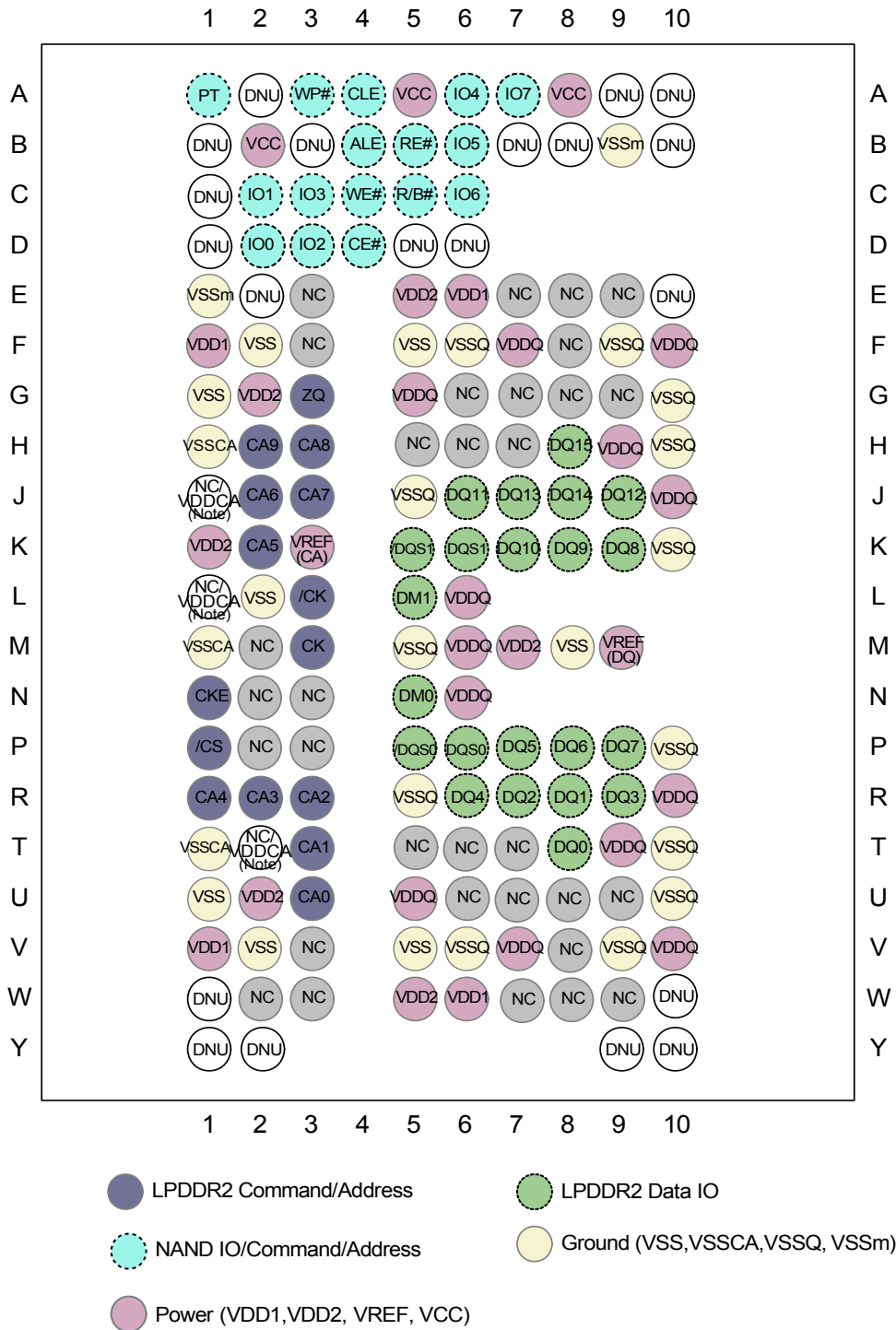

Note: Please check Product Selection Guide for NC pin or VDDCA pin support.

162-Ball, BGA (NAND x16; LPDDR x16)

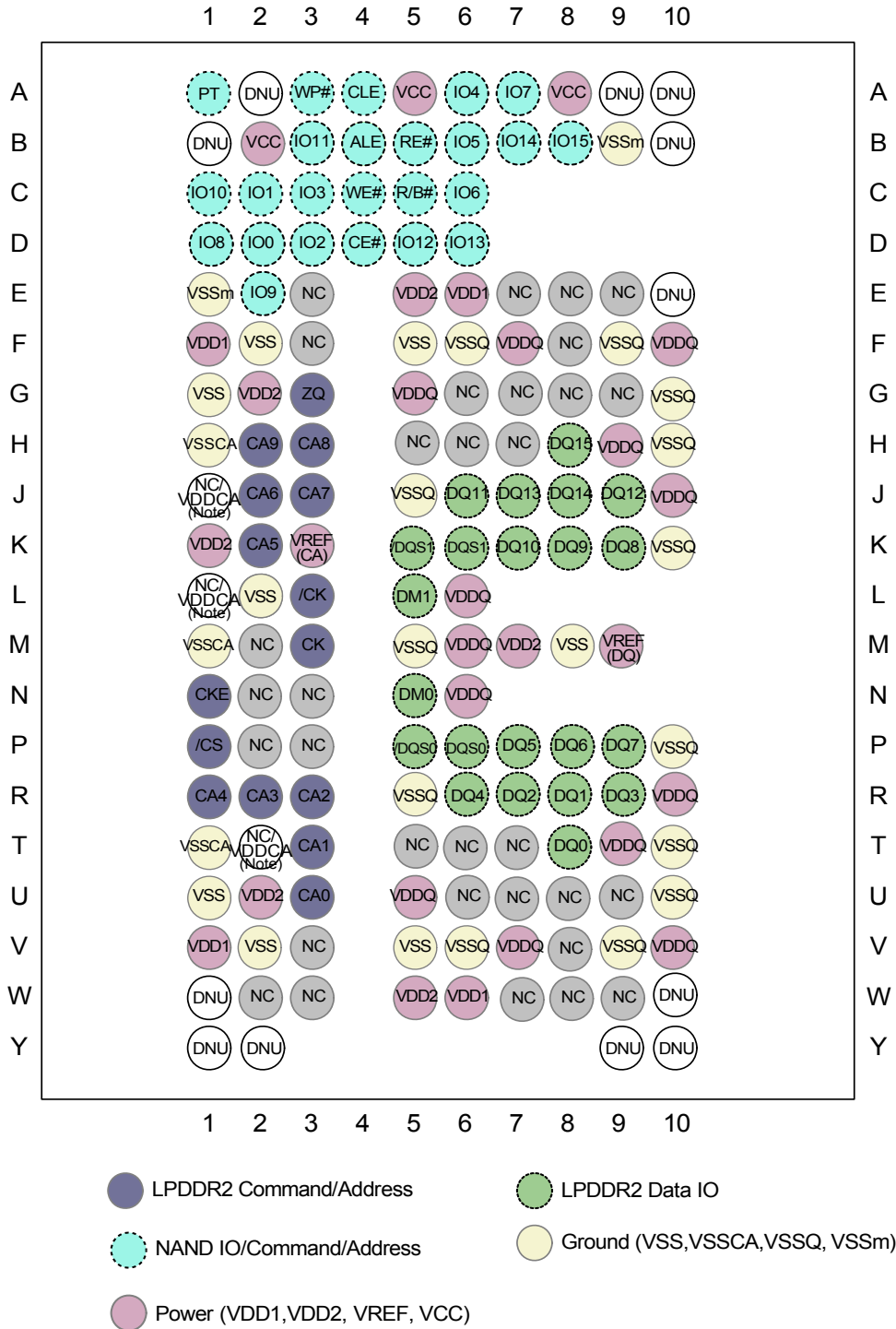

Note: Please check Product Selection Guide for NC pin or VDDCA pin support.

6. PIN DESCRIPTION

LPDDR2 x32

SYMBOL	DESCRIPTION	NAND Flash 4Gb (512Mb x8) 2Gb (256Mb x8) 1Gb (128Mb x8)	LPDDR2x32 2Gb (64Mb x32) 1Gb (32Mb x32) 512Mb (16Mb x32)
I/O0 - I/OX	Data Input / Output	V	
CLE	Command Latch Enable	V	
ALE	Address Latch Enable	V	
CE#	Chip Enable	V	
WE#	Write Enable	V	
RE#	Read Enable	V	
WP#	Write Protect	V	
R/B#	Ready / Busy Out	V	
VCC	Supply Voltage	V	
VSSm	Ground	V	
PT	Chip Protection Enable	V	
/CS	Chip Select		V
CK, /CK	Differential Clocks		V
CKE	Clock Enable		V
CA0 - CA9	Command / Address		V
DQ0 - DQ31	Data I/O		V
DM0 - DM3	Input Data Mask		V
DQS0 - DQS3	Differential Data Strobe (rising edge)		V
/DQS0 - /DQS3	Differential Data Strobe (falling edge)		V
ZQ	Drive Strength Calibration		V
VREF(DQ)	Reference Voltage		V
VREF(CA)	Reference Voltage		V
VDD1	Core Power Supply		V
VDD2	Core Power Supply		V
VSS, VSSCA, VSSQ	Ground		V
VDDQ	I/O Power Supply		V
VDDCA	CA Power Supply		V
NC	No Connection		V
DNU *	Do Not Use	V	V

* : DNU pin of NAND must keep floating.

LPDDR2 x16

SYMBOL	DESCRIPTION	NAND Flash	
		4Gb (512Mb x8) 2Gb (256Mb x8) 1Gb (128Mb x8)	LPDDR2 x16 1Gb(64Mb x16)
I/O0 - I/OX	Data Input / Output	V	
CLE	Command Latch Enable	V	
ALE	Address Latch Enable	V	
CE#	Chip Enable	V	
WE#	Write Enable	V	
RE#	Read Enable	V	
WP#	Write Protect	V	
R/B#	Ready / Busy Out	V	
VCC	Supply Voltage	V	
VSSm	Ground	V	
PT	Chip Protection Enable	V	
/CS	Chip Select		V
CK, /CK	Differential Clocks		V
CKE	Clock Enable		V
CA0 - CA9	Command / Address		V
DQ0-DQ15	Data I/O		V
DM0-DM1	Input Data Mask		V
DQS0-DQS1	Differential Data Strobe (rising edge)		V
/DQS0-/DQS1	Differential Data Strobe (falling edge)		V
ZQ	Drive Strength Calibration		V
VREF(DQ)	Reference Voltage		V
VREF(CA)	Reference Voltage		V
VDD1	Core Power Supply		V
VDD2	Core Power Supply		V
VSS, VSSCA, VSSQ	Ground		V
VDDQ	I/O Power Supply		V
VDDCA	CA Power Supply		V
NC	No Connection		V
DNU *	Do Not Use	V	V

* : DNU pin of NAND must keep floating.

7. PACKAGE INFORMATION

Doc. Title: Package Outline for CSP 162BALL(8X10.5X1.0MM,BALL PITCH 0.5MM,BALL DIAMETER 0.3MM)

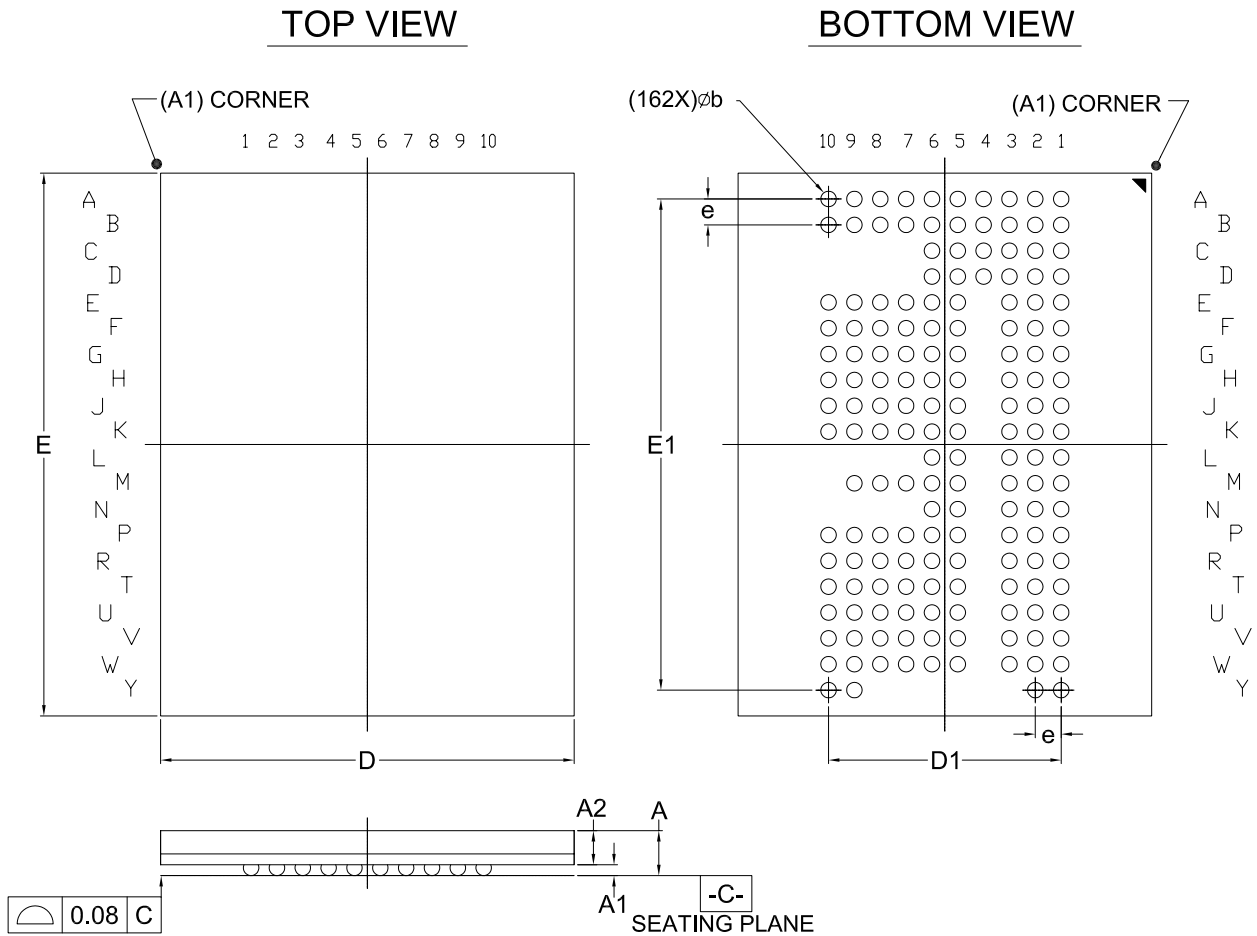

Dimensions (inch dimensions are derived from the original mm dimensions)

SYMBOL		A	A1	A2	b	D	D1	E	E1	e
UNIT										
mm	Min.	--	0.16	0.61	0.25	7.90	---	10.40	---	---
	Nom.	--	0.21	---	0.30	8.00	4.5	10.50	9.5	0.50
	Max.	1.00	0.26	---	0.35	8.10	---	10.60	---	---
Inch	Min.	---	0.006	0.024	0.010	0.311	---	0.409	---	---
	Nom.	---	0.008	---	0.012	0.315	0.177	0.413	0.374	0.020
	Max.	0.039	0.010	---	0.014	0.319	---	0.417	---	---

Dwg. No.	Revision	Reference			
		JEDEC	EIAJ		
6110-4270	0				

8. REVISION HISTORY

Revision No.	Description	Page	Date
1.0	1. Modified PART NAME DESCRIPTION 2. Removed the title "Advanced information" 3. Revised Bus information, Page program and Block erase time 4. Revised block diagram (NAND)	P4 All P2 P3	JUL/21/2014
1.1	1. Added VDD definition 2. Added two part numbers: MX63U2GC1GCAXMI00 and MX63U4GC2GBAXMI00	P2 P2,4,5	OCT/24/2014
1.2	1. Added part numbers: MX63U1GC1GAAXMI00, MX63U1GD1GAAXMI00, MX63U1GC1GAAXMI01, MX63U4GC2GBAXMI01, MX63U4GC2GGAXMI00, MX63U2GE2GGAXMI00, MX63U4GC2GGAXMI01 and MX63U2GE2GGAXMI01 2. Modified VDDCA pin 3. Revised PART NAME DESCRIPTION 4. Added PIN CONFIGURATIONS: NAND x16; LPDDR x16 5. Content modification 6. Added Option Code (Operation Temperature)	P3-6,9, 11-12 P7-10 P5 P10 P7-9 P3,5	APR/22/2015
1.3	1. Added part numbers: MX63U4GC2GHAXMI00, MX63U4GC2GHAXMI01 and MX63U2GE2GHAXMI00 2. Removed Advanced Information "*" for MX63U4GC2GBAXMI00 and MX63U1GD1GAAXMI00	P6 P6	MAY/29/2015
1.4	1. Removed two part numbers: MX63U4GB2GBAXMI00 and MX63U4GC2GBAXMI01 2. Added part number: MX63U4GA2GHAXMI00	P6 P6	JUN/11/2015
1.5	1. Removed Advanced Information "*" for three part numbers: MX63U2GC1GCAXMI00, MX63U1GC1GAAXMI00 and MX63U1GC1GAAXMI01	P6	OCT/29/2015
1.6	1. Added part number: MX63U2GE2GHAXMI01	P6	NOV/27/2015
1.7	1. Added part number: MX63U2GD1GCAXMI01	P6	DEC/14/2015
1.8	1. Added a statement for product ordering information. 2. Removed all Advanced Information "*" 3. Added two part numbers: MX63U2GC1GCAXMI01 MX63U1GC1GCAXMI01	P6 P6 P6	MAR/09/2016
1.9	1. Added a part number: MX63U1GC12HAXMI01	P6	OCT/18/2016



MACRONIX
INTERNATIONAL Co., LTD.

MX63UxG
162-Ball MCP

Except for customized products which has been expressly identified in the applicable agreement, Macronix's products are designed, developed, and/or manufactured for ordinary business, industrial, personal, and/or household applications only, and not for use in any applications which may, directly or indirectly, cause death, personal injury, or severe property damages. In the event Macronix products are used in contradicted to their target usage above, the buyer shall take any and all actions to ensure said Macronix's product qualified for its actual use in accordance with the applicable laws and regulations; and Macronix as well as it's suppliers and/or distributors shall be released from any and all liability arisen therefrom.

Copyright© Macronix International Co., Ltd. 2014-2016. All rights reserved, including the trademarks and tradename thereof, such as Macronix, MXIC, MXIC Logo, MX Logo, Integrated Solutions Provider, NBit, Nbit, NBit, Macronix NBit, eLiteFlash, HybridNVM, HybridFlash, XtraROM, Phines, KH Logo, BE-SONOS, KSMC, Kingtech, MXSMIO, Macronix vEE, Macronix MAP, Rich Audio, Rich Book, Rich TV, and FitCAM. The names and brands of third party referred thereto (if any) are for identification purposes only.

For the contact and order information, please visit Macronix's Web site at: <http://www.macronix.com>

MACRONIX INTERNATIONAL CO., LTD. reserves the right to change product and specifications without notice.