

# ZXCD1210

## High performance analog input Class D modulator

### Description

The ZXCD1210 provides complete control and modulation functions at the heart of high efficiency high performance Class D switching audio amplifier solutions. In combination with high performance output stages and open or closed loop architectures, the ZXCD1210 provides a high performance audio amplifier with all the inherent benefits of Class D.

The ZXCD1210 solution uses proprietary circuit design to realise the true benefits of Class D without the traditional drawback of poor distortion performance. The combination of reference circuit designs, magnetic component choice and layout are essential to realising these benefits.

The ZXCD1210 reference designs provide output powers up to 500W RMS with typical distortion and noise of less than 0.05% and a dynamic range of 98dB. The closed loop designs ensure a high damping factor and excellent supply rejection. The open loop designs provide high performance in the most economic implementation.

The closed loop reference designs include circuits specifically for subwoofer applications featuring a flat frequency response up to 250Hz. The open loop designs give the ZXCD1210 the ability to produce amplifiers with full a 20kHz bandwidth.

### Features

- Output power 50W to 500W into 4Ω
- THD+N <0.05%
- Dynamic range 98dB
- Open loop and closed loop reference designs
- Frequency response  
Subwoofers: ±0.5dB from 10Hz to 250Hz  
Full band: ±0.5dB from 20Hz to 20kHz
- 200kHz PWM frequency
- Output drive free of crossover artifacts
- QFN16 4x4 package

### Applications

- Subwoofers
- Home theatre systems
- Multimedia
- Wireless speakers
- Portable audio

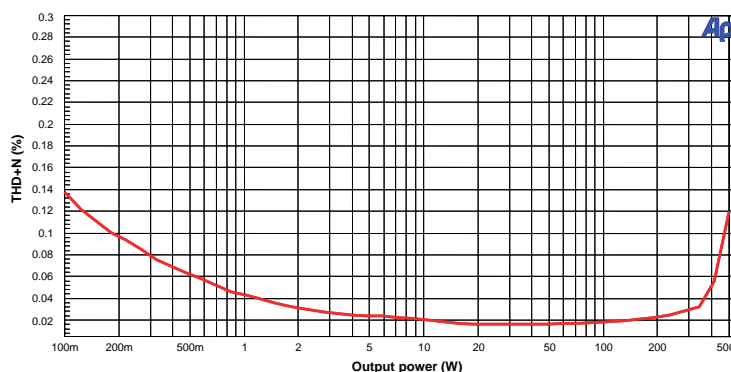

This plot shows the THD+N versus power plot for a 500W closed loop subwoofer reference design. THD+N is 0.02% between 10W and 200W which is outstanding performance.

# ZXCD1210

## Absolute maximum ratings - Terminal voltage with respect to GND

$V_{CC}$	20V
Power dissipation	1W
Package thermal resistance ( $\theta_{ja}$ )	55°C/W
Operating temperature range	-40°C to 70°C
Maximum junction temperature	125°C
Storage temperature range	-50°C to 85°C

Stresses beyond those listed under 'Absolute maximum ratings' may cause permanent damage to the device. These are stress ratings only, and functional operation of the device at these or any other conditions beyond those indicated in the operational sections of the specifications is not implied. Exposure to absolute maximum conditions for extended periods may affect device reliability.

## Electrical characteristics - Test conditions (unless otherwise stated) $V_{CC} = 16V$ , $T_A = 25^\circ C$

Symbol	Parameter	Conditions	Limits			Units
			Min.	Typ.	Max.	
$V_{CC}$	Operating voltage range	(*)	12	16	18	V
$I_{SS}$	Quiescent current	$V_{CC} = 12V$ $V_{CC} = 18V, 16V$			45 50	mA mA
$F_{CK}$	Clock frequency	Clock capacitor = 330pF	150	200	250	kHz
$T_{CK}$	Clock frequency tolerance	Clock capacitor = 330pF			±25	%
$V_{OLPWM}$	Low level PWM output voltage	No load			100	mV
$V_{OHPWM}$	High level PWM output voltage	No load	7.5			V
$T_{DR}$	PWM output rise and fall time	Load capacitance = 2200pF		50		ns
$T_{REG5V5}$	REG5V5 tolerance	1uF decoupling	5.23	5.5	5.77	V
$T_{REG9V}$	REF9V tolerance	1uF decoupling	8.32	8.75	9.18	V
$R_{AIN}$	Audio input impedance		1.35	1.8	2.3	k $\Omega$
$R_{SLI}$	Modulation input impedance		1.35	1.8	2.3	k $\Omega$
$B_{AIN}$	Audio input bias level		2.95	3.1	3.25	V
$B_{SLI}$	Modulation input bias level		2.95	3.1	3.25	V
$V_{CK}$	Clock amplitude		0.89	1.05	1.2	V

### NOTES:

(\*) For optimum thermal performance it is recommended that the ZXCD1210 is operated with a  $V_{CC}$  of 12V.

## Pin connection diagrams

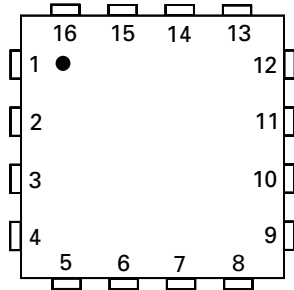

## QFN16 4x4 package

Pin no.	Pin name	Pin description
1	PWML	PWM drive
2	REG5V5	Internal supply rail
3	AINL	Audio input
4	MODIL	Modulation control
5	MODOL	Modulation control
6	N/C	No connection
7	CK	External capacitor to set PWM frequency
8	MODOR	Modulation control
9	MODIR	Modulation control
10	AINR	Audio input
11	Sgnd	Signal ground
12	PWMR	PWM drive
13	Pgnd	Power ground
14	REG9VR	Internal supply rail
15	VCC	Internal supply pin
16	REG9VL	Internal supply rail

## Functional description

On chip series regulators drop the external  $V_{CC}$  supply (12V recommended) to the 9V and 5.5V supplies required by the internal circuitry of the device.

The on chip oscillator produces a clock which is set to approximately 200kHz by an external capacitor and an on chip resistor. The clock is set at least an order higher in frequency than the audio input. This clock is a triangle waveform which is used to modulate the incident analogue signal in order to produce the required PWM output.

With no audio input signal applied, the PWM duty cycle is nominally 50%. As the audio input signal ascends towards the peak level, the crossing points with the (higher frequency) triangle wave also ascend. The PWM output exhibits a corresponding increase in output duty cycle. Similarly, as the audio input signal descends, the duty cycle is correspondingly reduced. Thus the triangle modulates the audio input generating a pulse width modulated (PWM) output. This principle is illustrated below.

The PWM outputs drive the speaker load with the audio information contained in the PWM signal, via the off chip gate drivers, H bridge and single stage LC filter network.

The triangle amplitude is approximately 1V. The audio inputs are internally biased to a DC voltage of approximately  $V_{CC}/5$ . The mid point DC level of the modulation control is around 2V. The triangular wave at the CK pin traverses between about 2.7V and 3.8V.

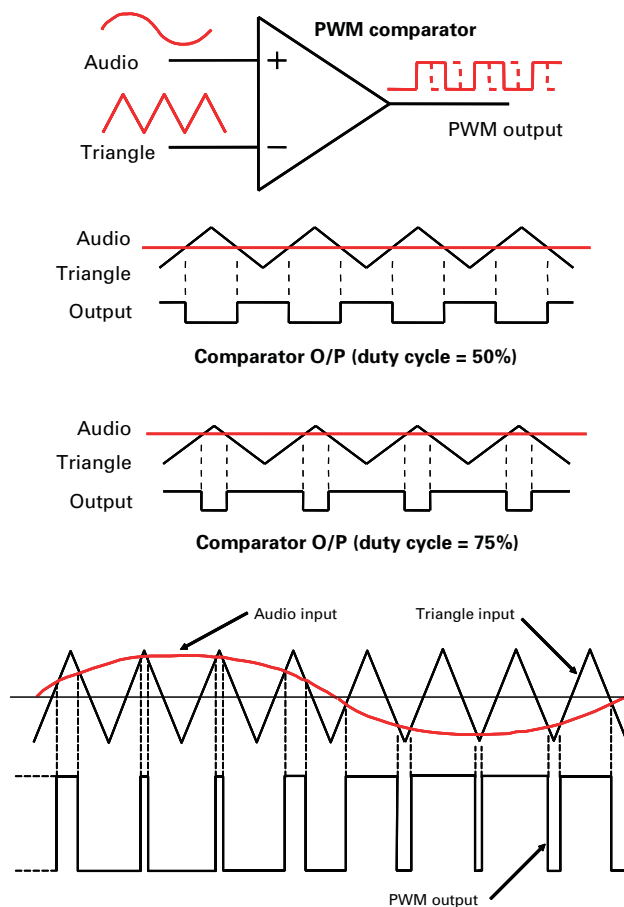

## Applications information

The high performance ZXCD1210 modulator IC forms the heart of the Zetex series of analog input Class D amplifier reference designs. The modulator device provides complete control of the modulation function.

Details of these reference designs are contained in individual data sheets: ZXCD50STEVAL and ZXCD100MOEVAL as well as the ZXCD series design guide.

The ZXCD50STEVAL series of reference circuits are specifically designed for subwoofer applications. These switching amplifiers owe much of their outstanding audio performance to a unique feedback architecture designed to reduce distortion. By taking its feedback signal from the filtered amplifier output, the high gain circuit design compensates for bridge mismatches and filter non-linearities, to achieve a reduction in THD+N across the entire power band.

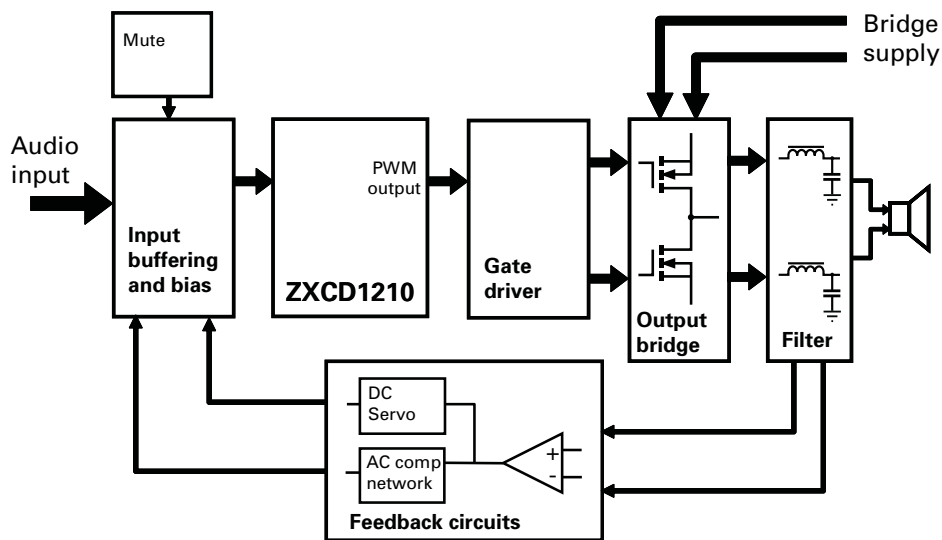

ZXCD50STEVAL series architecture

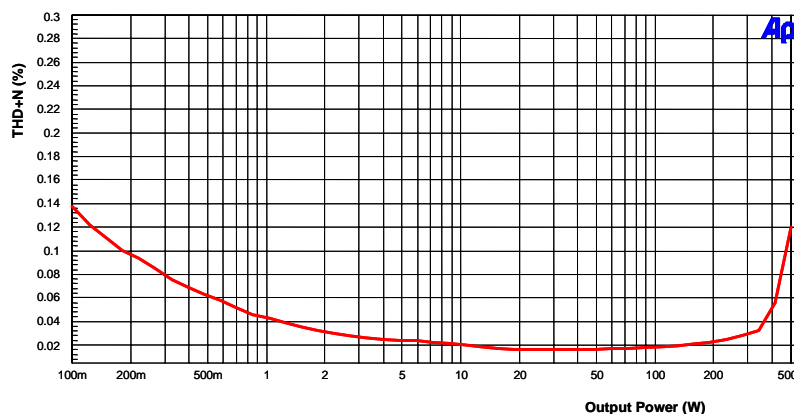

ZXCD50STEVAL series THD+N versus power

# ZXCD1210

The closed loop Class D architecture maintains high efficiency ensuring cool running in the smallest footprint whilst achieving much reduced output impedance for tight bass control. Additionally the feedback architecture compensates for supply dips and the bridge design accommodates high off load voltages. This means that use of a basic SMPS or an unregulated supply is achievable without compromising performance.

The designs feature soft start controls and under voltage lockout controls to maintain anti-pop behavior. Design options include short circuit, thermal and DC offset protection circuits. Volume and phase controls and high/low pass filters are simply added to the input circuitry.

The scalable architecture of the ZXCDSUBEV series utilises all N-channel output stage with either bridge tied load (BTL) or single ended (SE) configurations, together with power supply options to generate 150W, 300W or 500W RMS into 4Ω designs from a single platform. Many more power options readily produced.

The ZXCD50STEVAL stereo and ZXCD100MOEVAL mono reference designs have an open loop architecture and feature output stages constructed using Zetex MOSFETs directly driven from the ZXCD modulator device.

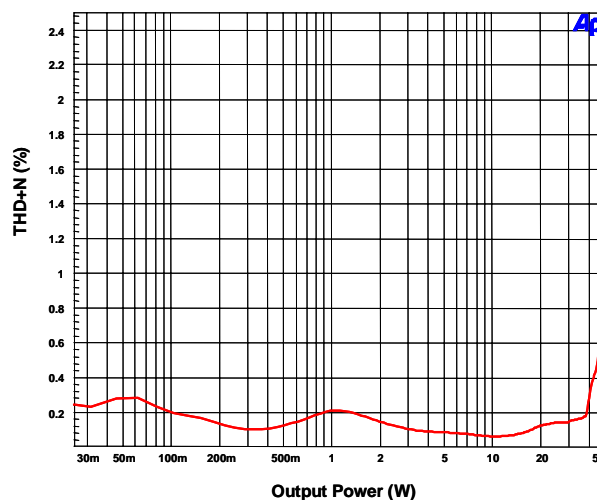

ZXCD50STEVAL THD+N versus output power

They offer 50W and 100W into 4Ω respectively with typical THD+N of 0.5% and 0.9% up to 90% full power. Careful design has eliminated any potential crossover distortion artifacts. Frequency response is flat to 20kHz in these designs, typical noise floor is -110dB. These designs feature anti-pop and over current protection and operate simply from a single supply rail.

Alternative configurations of these designs are possible with multi-channel applications simply created with a master slave arrangement. Single ended operation is possible with the associated performance compromises.

For further information on the ZXCD series reference designs, contact your local Zetex supplier with details of your production project requirements.

# ZXCD1210

## Package outline

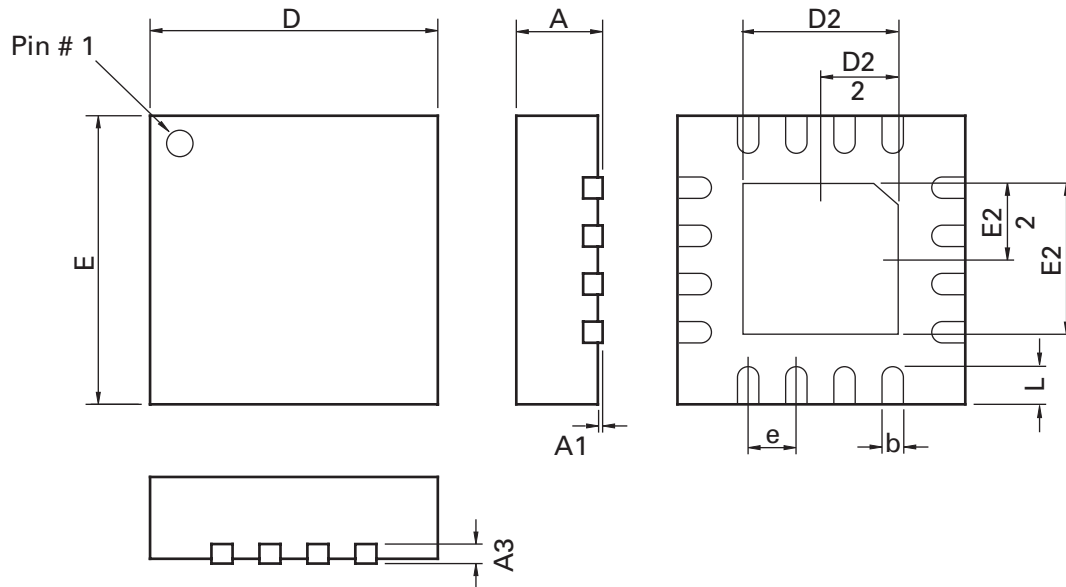

Dim.	Millimeters		Inches	
	Min.	Max.	Min.	Max.
A	0.70	0.80	0.028	0.032
A1	0.00	0.05	0.00	0.002
A3	0.178	0.228	0.007	0.009
b	0.25	0.35	0.010	0.014
D	3.95	4.05	0.156	0.159
D2	2.05	2.15	0.081	0.085
E	3.95	4.05	0.156	0.159
E2	2.05	2.15	0.081	0.085
e	0.65 BSC		0.026 BSC	
L	0.35	0.45	0.014	0.018

**Note:** Controlling dimensions are in millimeters. Approximate dimensions are provided in inches

## Ordering information

Device	Description	Package	Tape and reel suffix
ZXCD1210JB16	Class D modulator	QFN16 4x4	TA (1,000 per reel) TC (3,000 per reel)

## Definitions

### Product change

Zetex Semiconductors reserves the right to alter, without notice, specifications, design, price or conditions of supply of any product or service. Customers are solely responsible for obtaining the latest relevant information before placing orders.

### Applications disclaimer

The circuits in this design/application note are offered as design ideas. It is the responsibility of the user to ensure that the circuit is fit for the user's application and meets with the user's requirements. No representation or warranty is given and no liability whatsoever is assumed by Zetex with respect to the accuracy or use of such information, or infringement of patents or other intellectual property rights arising from such use or otherwise. Zetex does not assume any legal responsibility or will not be held legally liable (whether in contract, tort (including negligence), breach of statutory duty, restriction or otherwise) for any damages, loss of profit, business, contract, opportunity or consequential loss in the use of these circuit applications, under any circumstances.

### Life support

Zetex products are specifically not authorized for use as critical components in life support devices or systems without the express written approval of the Chief Executive Officer of Zetex Semiconductors plc. As used herein:

A. Life support devices or systems are devices or systems which:

1. are intended to implant into the body

or

2. support or sustain life and whose failure to perform when properly used in accordance with instructions for use provided in the labelling can be reasonably expected to result in significant injury to the user.

B. A critical component is any component in a life support device or system whose failure to perform can be reasonably expected to cause the failure of the life support device or to affect its safety or effectiveness.

### Reproduction

The product specifications contained in this publication are issued to provide outline information only which (unless agreed by the company in writing) may not be used, applied or reproduced for any purpose or form part of any order or contract or be regarded as a representation relating to the products or services concerned.

### Terms and Conditions

All products are sold subjects to Zetex' terms and conditions of sale, and this disclaimer (save in the event of a conflict between the two when the terms of the contract shall prevail) according to region, supplied at the time of order acknowledgement.

For the latest information on technology, delivery terms and conditions and prices, please contact your nearest Zetex sales office.

### Quality of product

Zetex is an ISO 9001 and TS16949 certified semiconductor manufacturer.

To ensure quality of service and products we strongly advise the purchase of parts directly from Zetex Semiconductors or one of our regionally authorized distributors. For a complete listing of authorized distributors please visit: [www.zetex.com/salesnetwork](http://www.zetex.com/salesnetwork)

Zetex Semiconductors does not warrant or accept any liability whatsoever in respect of any parts purchased through unauthorized sales channels.

### ESD (Electrostatic discharge)

Semiconductor devices are susceptible to damage by ESD. Suitable precautions should be taken when handling and transporting devices. The possible damage to devices depends on the circumstances of the handling and transporting, and the nature of the device. The extent of damage can vary from immediate functional or parametric malfunction to degradation of function or performance in use over time. Devices suspected of being affected should be replaced.

### Green compliance

Zetex Semiconductors is committed to environmental excellence in all aspects of its operations which includes meeting or exceeding regulatory requirements with respect to the use of hazardous substances. Numerous successful programs have been implemented to reduce the use of hazardous substances and/or emissions.

All Zetex components are compliant with the RoHS directive, and through this it is supporting its customers in their compliance with WEEE and ELV directives.

### Product status key:

"Preview"	Future device intended for production at some point. Samples may be available
"Active"	Product status recommended for new designs
"Last time buy (LTB)"	Device will be discontinued and last time buy period and delivery is in effect
"Not recommended for new designs"	Device is still in production to support existing designs and production
"Obsolete"	Production has been discontinued

### Datasheet status key:

"Draft version"	This term denotes a very early datasheet version and contains highly provisional information, which may change in any manner without notice.
"Provisional version"	This term denotes a pre-release datasheet. It provides a clear indication of anticipated performance. However, changes to the test conditions and specifications may occur, at any time and without notice.
"Issue"	This term denotes an issued datasheet containing finalized specifications. However, changes to specifications may occur, at any time and without notice.

### Zetex sales offices

Europe	Americas	Asia Pacific	Corporate Headquarters
Zetex GmbH Kustermann-park Balanstraße 59 D-81541 München Germany Telephone: (49) 89 45 49 49 0 Fax: (49) 89 45 49 49 49 europe.sales@zetex.com	Zetex Inc 700 Veterans Memorial Highway Hauppauge, NY 11788 USA Telephone: (1) 631 360 2222 Fax: (1) 631 360 8222 usa.sales@zetex.com	Zetex (Asia Ltd) 3701-04 Metroplaza Tower 1 Hing Fong Road, Kwai Fong Hong Kong Telephone: (852) 26100 611 Fax: (852) 24250 494 asia.sales@zetex.com	Zetex Semiconductors plc Zetex Technology Park, Chadderton Oldham, OL9 9LL United Kingdom Telephone: (44) 161 622 4444 Fax: (44) 161 622 4446 hq@zetex.com

© 2007 Published by Zetex Semiconductors plc