

NCP331

Soft-Start Controlled Load Switch with Auto Discharge

The NCP331 is a low $R_{DS(on)}$ N-channel MOSFET controlled by a soft-start sequence of 2 ms for mobile applications. The very low $R_{DS(on)}$ allows system supplying or battery charging up to DC 2A. The device is enable due to external, active high, enable pin.

Due to a current consumption optimization, leakage current is drastically decreased from the battery connected to the device, allowing long battery life.

Features

- 1.8 V – 5.5 V Operating Range
- 33 mΩ N MOSFET
- DC Current Up to 2 A
- Peak Current Up to 5 A
- Built-in Soft-Start 2 ms
- Reverse Voltage Protection
- Output Discharge
- EN Logic Pin: Active High
- ESD Ratings:
Machine Model = B
Human Body Model = 2
- TSOP23–6 package
- This is a Pb–Free Device

Typical Applications

- Mobile Phones
- Tablets
- Digital Cameras
- GPS
- Computers



ON Semiconductor®

<http://onsemi.com>



**TSOP-6
SN SUFFIX
CASE 318G**

MARKING DIAGRAM

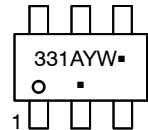

331 = Specific Device Code
A = Assembly Location
Y = Year
W = Work Week
▪ = Pb-Free Package

(Note: Microdot may be in either location)

PINOUT DIAGRAM

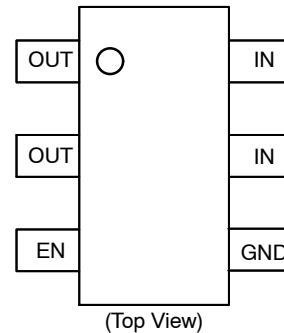

ORDERING INFORMATION

See detailed ordering and shipping information on page 7 of this data sheet.

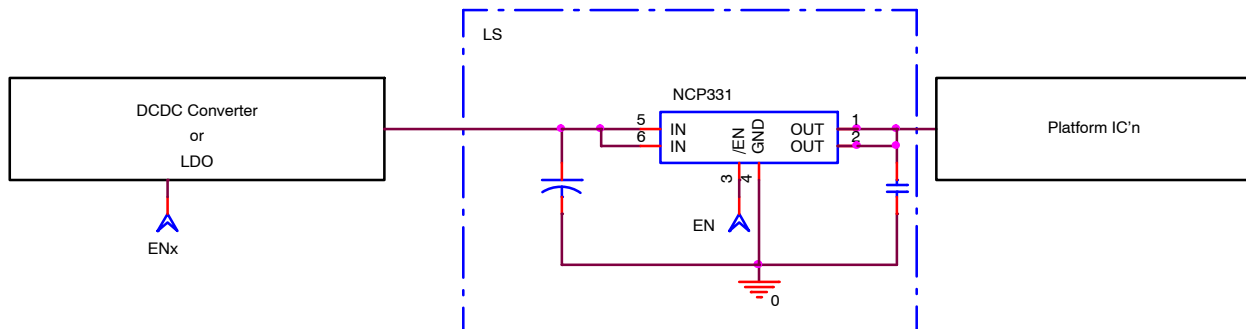

Figure 1. Typical Application Circuit

NCP331

PIN FUNCTION DESCRIPTION

Pin Name	Pin Number	Type	Description
IN	5,6	POWER	Power-switch input voltage; connect a 0.1 μ F or greater ceramic capacitor from IN to GND as close as possible to the IC.
GND	4	POWER	Ground connection.
EN	3	INPUT	Enable input, logic high turns on power switch.
OUT	1,2	OUTPUT	Power-switch output; connect a 0.1 μ F ceramic capacitor from OUT to GND as close as possible to the IC is recommended.

BLOCK DIAGRAM

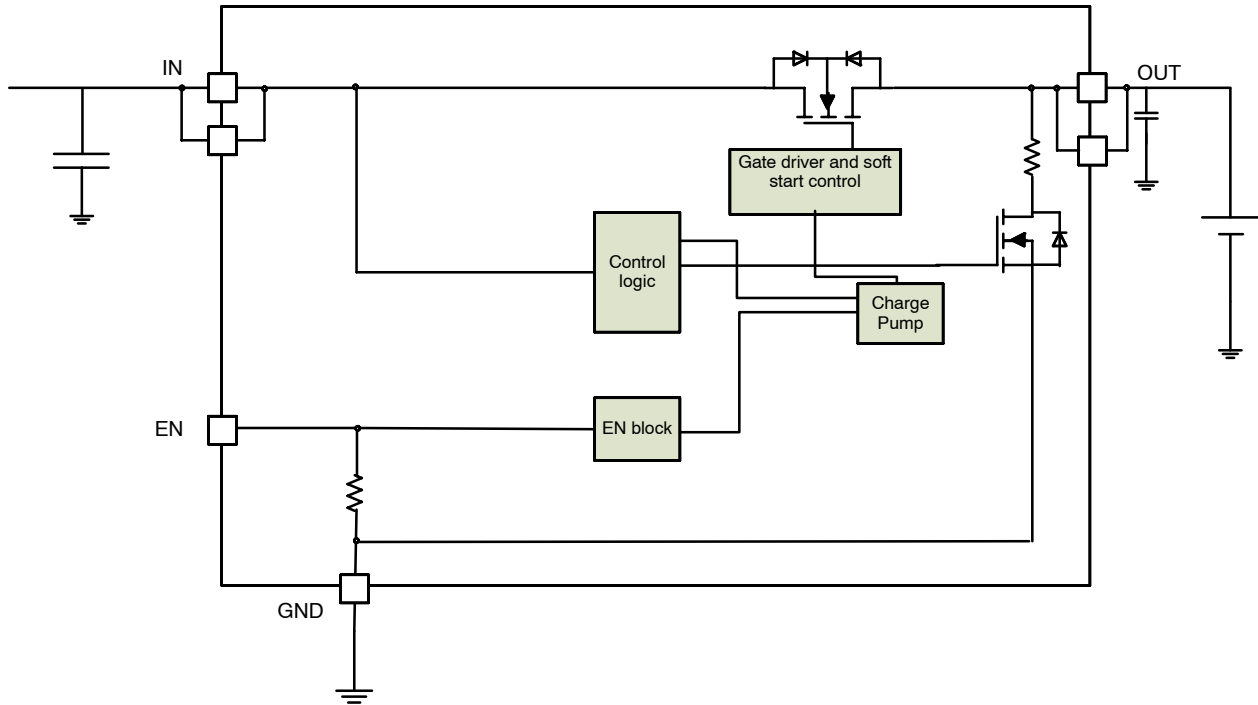

Figure 2. Block Diagram

NCP331

MAXIMUM RATINGS

Rating	Symbol	Value	Unit
IN, OUT, EN, Pins:	V_{EN}, V_{IN}, V_{OUT}	-0.3 to +7.0	V
From IN to OUT Pins: Input/Output	V_{IN}, V_{OUT}	-7.0 to +7.0	V
Maximum Junction Temperature Range	T_J	-40 to +125	°C
Storage Temperature Range	T_{STG}	-40 to +150	°C
ESD Withstand Voltage Human Body model (HBM), model = 2, Machine Model (MM) model = B, (Note 1)	Vesd	2500 200	V
Moisture Sensitivity (Note 2)	MSL	Level 1	

Stresses exceeding those listed in the Maximum Ratings table may damage the device. If any of these limits are exceeded, device functionality should not be assumed, damage may occur and reliability may be affected.

1. According to JEDEC standard JESD22-A108.
2. Moisture Sensitivity Level (MSL): 1 per IPC/JEDEC standard: J-STD-020.

OPERATING CONDITIONS

Symbol	Parameter	Conditions	Min	Typ	Max	Unit
V_{IN}	Operational Power Supply		1.8		5.5	V
V_{EN}	Enable Voltage		0		5.5	
T_A	Ambient Temperature Range		-40	25	+ 85	°C
T_J	Junction Temperature Range		-40	25	+ 125	°C
C_{IN}	Decoupling Input Capacitor		0.1			μF
C_{OUT}	Decoupling Output Capacitor		0.1			μF
$R_{\theta JA}$	Thermal Resistance – Junction-to-Air	(Notes 3 and 4)		305		°C/W
I_{OUT}	Maximum DC Current				2	A
P_D	Power Dissipation Rating (Note 7)	$T_A \leq 25^\circ\text{C}$		0.37		W
		$T_A = 85^\circ\text{C}$		0.13		W

Functional operation above the stresses listed in the Recommended Operating Ranges is not implied. Extended exposure to stresses beyond the Recommended Operating Ranges limits may affect device reliability.

3. The $R_{\theta JA}$ is dependent of the PCB heat dissipation.
4. The maximum power dissipation (P_D) is given by the following formula:

NCP331

ELECTRICAL CHARACTERISTICS Min & Max Limits apply for T_A between -40°C to $+85^{\circ}\text{C}$ and T_J up to $+125^{\circ}\text{C}$ for V_{IN} between 1.8 V to 5.5 V (Unless otherwise noted). Typical values are referenced to $T_A = +25^{\circ}\text{C}$ and $V_{IN} = 5\text{ V}$.

Symbol	Parameter	Conditions	Min	Typ	Max	Unit
--------	-----------	------------	-----	-----	-----	------

POWER SWITCH

$R_{DS(on)}$	Static drain-source on-state resistance	$V_{IN} = 3\text{ V}, V_{IN} = 5\text{ V},$ TSOP package	$T_J = 25^{\circ}\text{C}$		33		m Ω
			$-40^{\circ}\text{C} < T_J < 125^{\circ}\text{C}$			60	
T_{EN}	Gate turn on	$V_{IN} = 3.3\text{ V}$	From EN V_{ih} to V_{OUT} rising. (Note 5), $C_{LOAD} = 0.1\ \mu\text{F}, R_{LOAD} = 10\ \Omega$		60	200	μs
		$V_{IN} = 3.0\text{ V}$	From EN V_{ih} to 10% V_{OUT} rising. $C_{LOAD} = 1\ \mu\text{F}, R_{LOAD} = 25\ \Omega$		278	500	μs
T_R	Output rise time	$V_{IN} = 3.3\text{ V}$	$C_{LOAD} = 0.1\ \mu\text{F}, R_{LOAD} = 10\ \Omega$ (Note 5), from En to 95% V_{OUT}	1.2	2.05	3	ms
		$V_{IN} = 3.0\text{ V}$	$C_{LOAD} = 1\ \mu\text{F}, R_{LOAD} = 25\ \Omega$ (Note 6), from 10% to 90% V_{OUT}	1.00	1.65	2.36	
T_{dis}	Disable time	$V_{IN} = 3.0\text{ V}$	From EN high to low to V_{OUT} falling		0.3		
T_F	Output fall time	$V_{IN} = 3\text{ V}$	$C_{LOAD} = 1\ \mu\text{F}, R_{LOAD} = 25\ \Omega$ (Note 6)	0.1	0.18	0.5	
T_{OFF}	Output off time	$V_{IN} = 3\text{ V}$	$C_{LOAD} = 1\ \mu\text{F}, R_{LOAD} = 25\ \Omega$ (Notes 6 & 7), from EN to 10% V_{OUT}	0.3	0.5	0.8	

ENABLE INPUT EN

V_{IH}	High-level input voltage		1.15			V
V_{IL}	Low-level input voltage				0.85	V
R_{pd}	En pull-down resistor		1.1	1.5	1.8	M Ω
R_{dis}	Output discharge resistor		200	400	600	Ω

REVERSE-LEAKAGE PROTECTION

I_{REV}	Reverse-current protection	$V_{IN} = 0\text{ V}, V_{OUT} = 4.2\text{ V}$ (part disable), $T_A = 25^{\circ}\text{C}$		0.3	1.2	μA
-----------	----------------------------	--	--	-----	-----	---------------

QUIESCENT CURRENT

I_{stb}	Standby current	En low, $V_{in} = 3\text{ V}$		1.3	3	μA
I_q	Current consumption	No load, En high, $V_{in} = 3\text{ V}$		11	15	μA

Product parametric performance is indicated in the Electrical Characteristics for the listed test conditions, unless otherwise noted. Product performance may not be indicated by the Electrical Characteristics if operated under different conditions.

5. Guaranteed by correlation with 3.0 V production test.

6. Parameters are guaranteed for C_{LOAD} and R_{LOAD} connected to the OUT pin with respect to the ground.

7. Guaranteed by T_{fall} and $R_{discharge}$ tests.

NCP331

TIMINGS

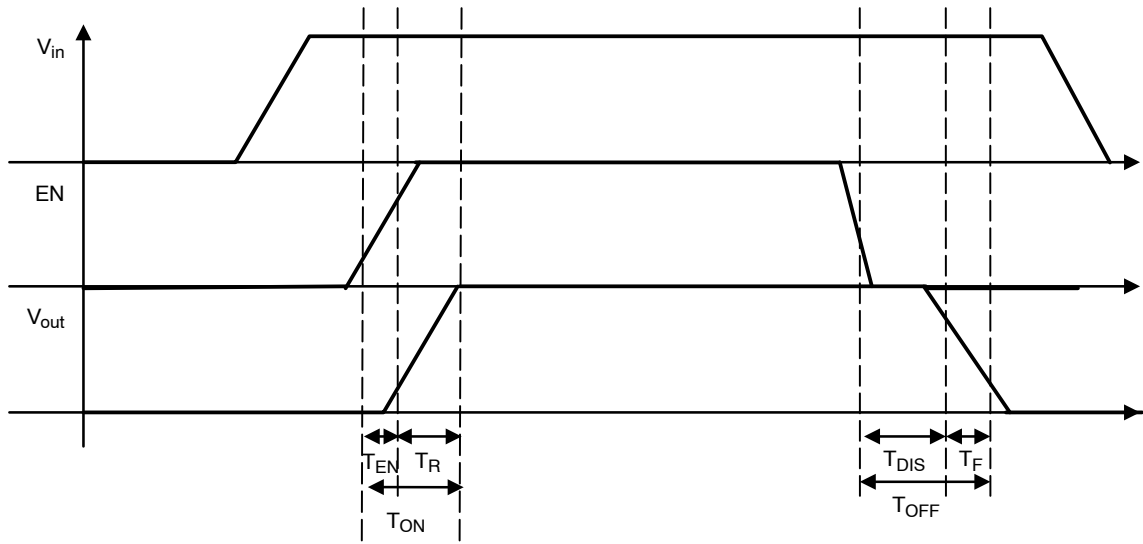

Figure 3. Timings

TYPICAL CHARACTERISTICS

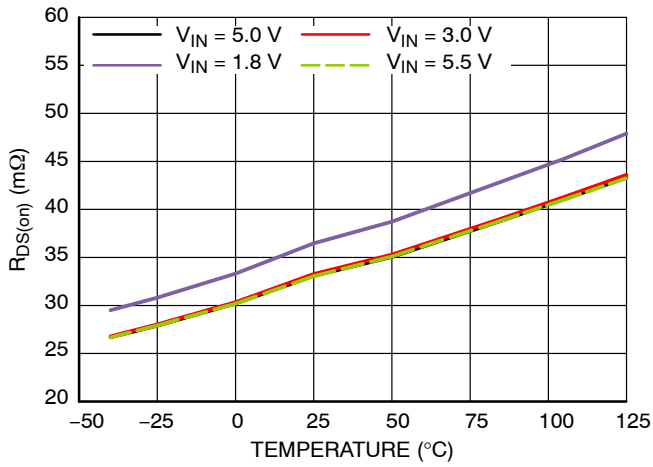

Figure 4. $R_{DS(on)}$ versus Temperature

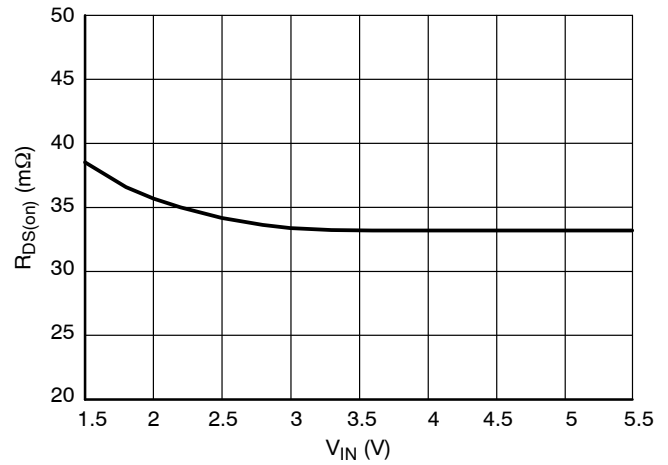

Figure 5. $R_{DS(on)}$ versus Input Voltage, Ambient Temperature

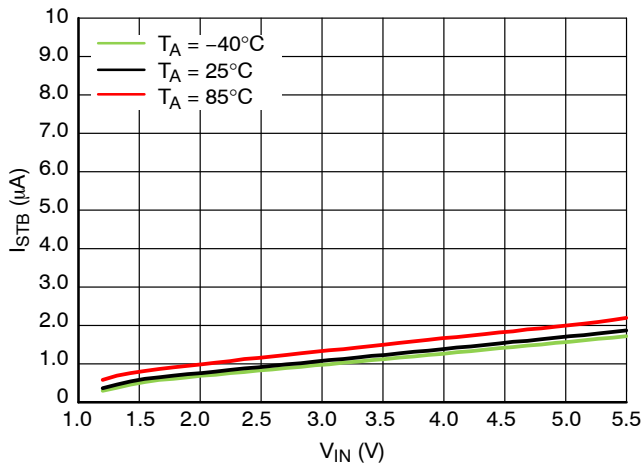

Figure 6. Standby Current versus Input Voltage

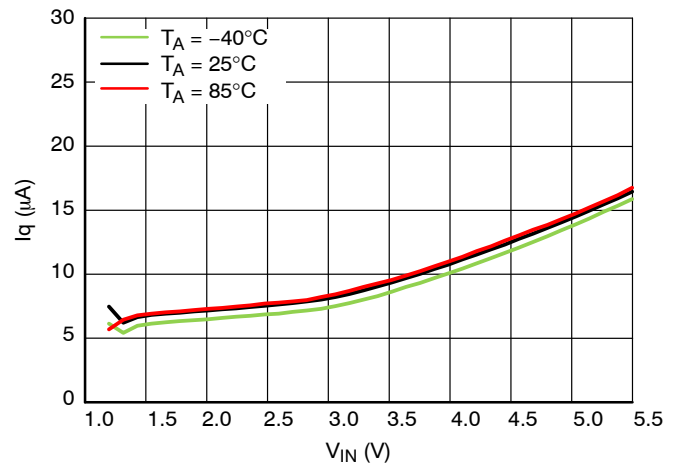

Figure 7. Quiescent Current versus Input Voltage

NCP331

FUNCTIONAL DESCRIPTION

Overview

The NCP331 is a high side N channel MOSFET power distribution switch designed to connect external voltage directly to the system.

Enable Input

Enable pin is an active high.

The part is in disable mode when EN is tied to low. Power MOSFET is opened. Pull down resistor is placed to maintained the part off if En pin is not externally driven.

The parts becomes in enable mode if EN is tied high and Power MOSFET is turned of after ten and t_{rise} times.

Auto Discharge

NMOS FET is placed between the output pin and GND, in order to discharge the application capacitor connected on OUT pin.

The auto-discharge is activated when EN pin is set to low level (disable state).

The discharge path (Pull down NMOS) stays activated as long as EN pin is set at low level.

Blocking Control

The blocking control circuitry switches the bulk of the power NMOS. When the part is off (No V_{in} or EN tied to GND externally), the body diode limits the leakage current I_{REV} from OUT to IN. In this mode, anode of the body diode is connected to IN pin and cathode is connected to OUT pin. In operating condition, anode of the body diode is connected to OUT pin and cathode is connected to IN pin preventing the discharge of the power supply.

APPLICATION INFORMATION

Power Dissipation

The device's junction temperature depends on different contributor factor such as board layout, ambient temperature, device environment, etc... Yet, the main contributor in term of junction temperature is the power dissipation of the power MOSFET. Assuming this, the power dissipation and the junction temperature in normal mode can be calculated with the following equations:

$$P_D = R_{DS(on)} \times (I_{OUT})^2$$

P_D = Power dissipation (W)
 $R_{DS(on)}$ = Power MOSFET on resistance (Ω)
 I_{OUT} = Output current (A)

$$T_J = P_D \times R_{\theta JA} + T_A$$

T_J = Junction temperature ($^{\circ}C$)
 $R_{\theta JA}$ = Package thermal resistance ($^{\circ}C/W$)
 T_A = Ambient temperature ($^{\circ}C$)

PCB Recommendations

The NCP331 integrates an up to 2A rated NMOS FET, and the PCB design rules must be respected to properly evacuate the heat out of the silicon. By increasing PCB area, the $R_{\theta JA}$ of the package can be decreased, allowing higher power dissipation.

ORDERING INFORMATION

Device	Marking	Package	Shipping [†]
NCP331SNT1G	331	TSOP-6 (Pb-Free)	3000 / Tape & Reel

[†]For information on tape and reel specifications, including part orientation and tape sizes, please refer to our Tape and Reel Packaging Specifications Brochure, BRD8011/D.

MECHANICAL CASE OUTLINE

PACKAGE DIMENSIONS

ON Semiconductor®



SCALE 2:1

TSOP-6 CASE 318G-02 ISSUE V

DATE 12 JUN 2012

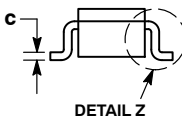
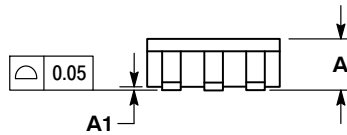
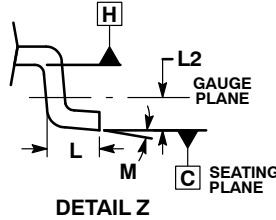
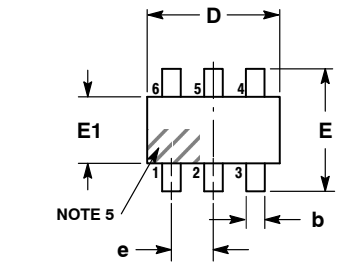

NOTES:

1. DIMENSIONING AND TOLERANCING PER ASME Y14.5M, 1994.
2. CONTROLLING DIMENSION: MILLIMETERS.
3. MAXIMUM LEAD THICKNESS INCLUDES LEAD FINISH. MINIMUM LEAD THICKNESS IS THE MINIMUM THICKNESS OF BASE MATERIAL.
4. DIMENSIONS D AND E1 DO NOT INCLUDE MOLD FLASH, PROTRUSIONS, OR GATE BURRS. MOLD FLASH, PROTRUSIONS, OR GATE BURRS SHALL NOT EXCEED 0.15 PER SIDE. DIMENSIONS D AND E1 ARE DETERMINED AT DATUM H.
5. PIN ONE INDICATOR MUST BE LOCATED IN THE INDICATED ZONE.

DIM	MILLIMETERS		
	MIN	NOM	MAX
A	0.90	1.00	1.10
A1	0.01	0.06	0.10
b	0.25	0.38	0.50
c	0.10	0.18	0.26
D	2.90	3.00	3.10
E	2.50	2.75	3.00
E1	1.30	1.50	1.70
e	0.85	0.95	1.05
L	0.20	0.40	0.60
L2	0.25 BSC		
M	0°	-	10°

- | | | | | | |
|--|--|---|---|---|--|
| <p>STYLE 1:
PIN 1. DRAIN
2. DRAIN
3. GATE
4. SOURCE
5. DRAIN
6. DRAIN</p> | <p>STYLE 2:
PIN 1. EMITTER 2
2. BASE 1
3. COLLECTOR 1
4. EMITTER 1
5. BASE 2
6. COLLECTOR 2</p> | <p>STYLE 3:
PIN 1. ENABLE
2. N/C
3. R BOOST
4. Vz
5. V in
6. V out</p> | <p>STYLE 4:
PIN 1. N/C
2. V in
3. NOT USED
4. GROUND
5. ENABLE
6. LOAD</p> | <p>STYLE 5:
PIN 1. EMITTER 2
2. BASE 2
3. COLLECTOR 1
4. EMITTER 1
5. BASE 1
6. COLLECTOR 2</p> | <p>STYLE 6:
PIN 1. COLLECTOR
2. COLLECTOR
3. BASE
4. EMITTER
5. COLLECTOR
6. COLLECTOR</p> |
| <p>STYLE 7:
PIN 1. COLLECTOR
2. COLLECTOR
3. BASE
4. N/C
5. COLLECTOR
6. EMITTER</p> | <p>STYLE 8:
PIN 1. Vbus
2. D(in)
3. D(in)+
4. D(out)+
5. D(out)
6. GND</p> | <p>STYLE 9:
PIN 1. LOW VOLTAGE GATE
2. DRAIN
3. SOURCE
4. DRAIN
5. DRAIN
6. HIGH VOLTAGE GATE</p> | <p>STYLE 10:
PIN 1. D(OUT)+
2. GND
3. D(OUT)-
4. D(IN)-
5. VBUS
6. D(IN)+</p> | <p>STYLE 11:
PIN 1. SOURCE 1
2. DRAIN 2
3. DRAIN 2
4. SOURCE 2
5. GATE 1
6. DRAIN 1/GATE 2</p> | <p>STYLE 12:
PIN 1. I/O
2. GROUND
3. I/O
4. I/O
5. VCC
6. I/O</p> |
| <p>STYLE 13:
PIN 1. GATE 1
2. SOURCE 2
3. GATE 2
4. DRAIN 2
5. SOURCE 1
6. DRAIN 1</p> | <p>STYLE 14:
PIN 1. ANODE
2. SOURCE
3. GATE
4. CATHODE/DRAIN
5. CATHODE/DRAIN
6. CATHODE/DRAIN</p> | <p>STYLE 15:
PIN 1. ANODE
2. SOURCE
3. GATE
4. DRAIN
5. N/C
6. CATHODE</p> | <p>STYLE 16:
PIN 1. ANODE/CATHODE
2. BASE
3. EMITTER
4. COLLECTOR
5. ANODE
6. CATHODE</p> | <p>STYLE 17:
PIN 1. EMITTER
2. BASE
3. ANODE/CATHODE
4. ANODE
5. CATHODE
6. COLLECTOR</p> | |

RECOMMENDED SOLDERING FOOTPRINT*

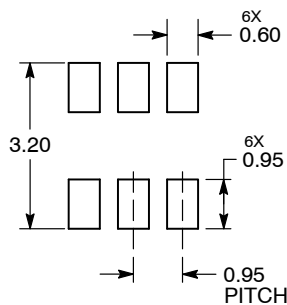

DIMENSIONS: MILLIMETERS

GENERIC MARKING DIAGRAM*



- | | |
|--|---|
| <p>XXX = Specific Device Code
A = Assembly Location
Y = Year
W = Work Week
▪ = Pb-Free Package</p> | <p>XXX = Specific Device Code
M = Date Code
▪ = Pb-Free Package</p> |
|--|---|

*For additional information on our Pb-Free strategy and soldering details, please download the ON Semiconductor Soldering and Mounting Techniques Reference Manual, SOLDERRM/D.

*This information is generic. Please refer to device data sheet for actual part marking. Pb-Free indicator, "G" or microdot "▪", may or may not be present.

DOCUMENT NUMBER:	98ASB14888C	Electronic versions are uncontrolled except when accessed directly from the Document Repository. Printed versions are uncontrolled except when stamped "CONTROLLED COPY" in red.
DESCRIPTION:	TSOP-6	PAGE 1 OF 1

ON Semiconductor and ON are trademarks of Semiconductor Components Industries, LLC dba ON Semiconductor or its subsidiaries in the United States and/or other countries. ON Semiconductor reserves the right to make changes without further notice to any products herein. ON Semiconductor makes no warranty, representation or guarantee regarding the suitability of its products for any particular purpose, nor does ON Semiconductor assume any liability arising out of the application or use of any product or circuit, and specifically disclaims any and all liability, including without limitation special, consequential or incidental damages. ON Semiconductor does not convey any license under its patent rights nor the rights of others.

ON Semiconductor and  are trademarks of Semiconductor Components Industries, LLC dba ON Semiconductor or its subsidiaries in the United States and/or other countries. ON Semiconductor owns the rights to a number of patents, trademarks, copyrights, trade secrets, and other intellectual property. A listing of ON Semiconductor's product/patent coverage may be accessed at www.onsemi.com/site/pdf/Patent-Marking.pdf. ON Semiconductor reserves the right to make changes without further notice to any products herein. ON Semiconductor makes no warranty, representation or guarantee regarding the suitability of its products for any particular purpose, nor does ON Semiconductor assume any liability arising out of the application or use of any product or circuit, and specifically disclaims any and all liability, including without limitation special, consequential or incidental damages. Buyer is responsible for its products and applications using ON Semiconductor products, including compliance with all laws, regulations and safety requirements or standards, regardless of any support or applications information provided by ON Semiconductor. "Typical" parameters which may be provided in ON Semiconductor data sheets and/or specifications can and do vary in different applications and actual performance may vary over time. All operating parameters, including "Typicals" must be validated for each customer application by customer's technical experts. ON Semiconductor does not convey any license under its patent rights nor the rights of others. ON Semiconductor products are not designed, intended, or authorized for use as a critical component in life support systems or any FDA Class 3 medical devices or medical devices with a same or similar classification in a foreign jurisdiction or any devices intended for implantation in the human body. Should Buyer purchase or use ON Semiconductor products for any such unintended or unauthorized application, Buyer shall indemnify and hold ON Semiconductor and its officers, employees, subsidiaries, affiliates, and distributors harmless against all claims, costs, damages, and expenses, and reasonable attorney fees arising out of, directly or indirectly, any claim of personal injury or death associated with such unintended or unauthorized use, even if such claim alleges that ON Semiconductor was negligent regarding the design or manufacture of the part. ON Semiconductor is an Equal Opportunity/Affirmative Action Employer. This literature is subject to all applicable copyright laws and is not for resale in any manner.

PUBLICATION ORDERING INFORMATION

LITERATURE FULFILLMENT:

Email Requests to: orderlit@onsemi.com

ON Semiconductor Website: www.onsemi.com

TECHNICAL SUPPORT

North American Technical Support:
Voice Mail: 1 800-282-9855 Toll Free USA/Canada
Phone: 011 421 33 790 2910

Europe, Middle East and Africa Technical Support:

Phone: 00421 33 790 2910

For additional information, please contact your local Sales Representative