

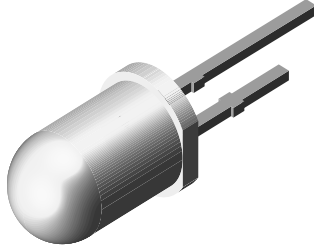

## Infrared Emitting Diode, 950 nm, GaAs



94 8390

## FEATURES

- Package type: leaded
- Package form: T-1 $\frac{3}{4}$
- Dimensions (in mm):  $\varnothing$  5
- Leads with stand-off
- Peak wavelength:  $\lambda_p = 950$  nm
- High reliability
- Angle of half intensity:  $\varphi = \pm 15^\circ$
- Low forward voltage
- Suitable for high pulse current operation
- Good spectral matching with Si photodetectors
- Material categorization: for definitions of compliance please see [www.vishay.com/doc?99912](http://www.vishay.com/doc?99912)



**RoHS**  
COMPLIANT  
HALOGEN  
**FREE**  
**GREEN**  
(5-2008)

## DESCRIPTION

TSUS5200 is an infrared, 950 nm emitting diode in GaAs technology molded in a blue-gray tinted plastic package.

## APPLICATIONS

- Infrared remote control and free air transmission systems with low forward voltage and small package requirements
- Emitter in transmissive sensors
- Emitter in reflective sensors

## PRODUCT SUMMARY

COMPONENT	$I_e$ (mW/sr)	$\varphi$ ( $^\circ$ )	$\lambda_p$ (nm)	$t_r$ (ns)
TSUS5200	20	$\pm 15$	950	800
TSUS5201	25	$\pm 15$	950	800
TSUS5202	30	$\pm 15$	950	800

## Note

- Test conditions see table "Basic Characteristics"

## ORDERING INFORMATION

ORDERING CODE	PACKAGING	REMARKS	PACKAGE FORM
TSUS5200	Bulk	MOQ: 4000 pcs, 4000 pcs/bulk	T-1 $\frac{3}{4}$
TSUS5201	Bulk	MOQ: 4000 pcs, 4000 pcs/bulk	T-1 $\frac{3}{4}$
TSUS5202	Bulk	MOQ: 4000 pcs, 4000 pcs/bulk	T-1 $\frac{3}{4}$

## Note

- MOQ: minimum order quantity

ABSOLUTE MAXIMUM RATINGS ( $T_{amb} = 25$  °C, unless otherwise specified)

PARAMETER	TEST CONDITION	SYMBOL	VALUE	UNIT
Reverse voltage		$V_R$	5	V
Forward current		$I_F$	150	mA
Peak forward current	$t_p/T = 0.5$ , $t_p = 100$ $\mu$ s	$I_{FM}$	300	mA
Surge forward current	$t_p = 100$ $\mu$ s	$I_{FSM}$	2.5	A
Power dissipation		$P_V$	170	mW
Junction temperature		$T_j$	100	$^\circ$ C
Operating temperature range		$T_{amb}$	-40 to +85	$^\circ$ C
Storage temperature range		$T_{stg}$	-40 to +100	$^\circ$ C
Soldering temperature	$t \leq 5$ s, 2 mm from case	$T_{sd}$	260	$^\circ$ C
Thermal resistance junction to ambient	J-STD-051, leads 7 mm, soldered on PCB	$R_{thJA}$	230	K/W

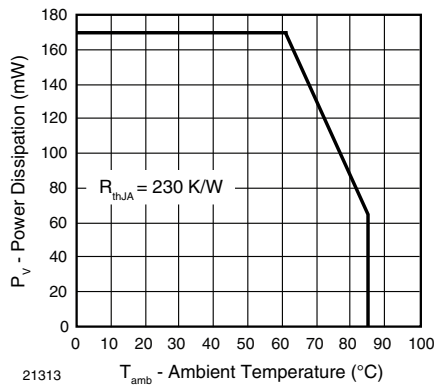

Fig. 1 - Power Dissipation Limit vs. Ambient Temperature

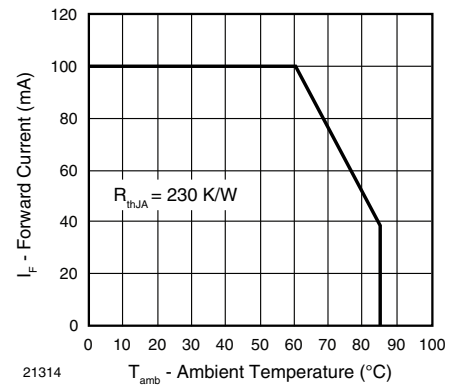

Fig. 2 - Forward Current Limit vs. Ambient Temperature

BASIC CHARACTERISTICS ( $T_{amb} = 25\text{ }^{\circ}\text{C}$ , unless otherwise specified)						
PARAMETER	TEST CONDITION	SYMBOL	MIN.	TYP.	MAX.	UNIT
Forward voltage	$I_F = 100\text{ mA}$ , $t_p = 20\text{ ms}$	$V_F$	-	1.3	1.7	V
Temperature coefficient of $V_F$	$I_F = 100\text{ mA}$	$TK_{V_F}$	-	-1.3	-	mV/K
Reverse current	$V_R = 5\text{ V}$	$I_R$	-	-	100	$\mu\text{A}$
Junction capacitance	$V_R = 0\text{ V}$ , $f = 1\text{ MHz}$ , $E = 0$	$C_j$	-	30	-	pF
Temperature coefficient of $\phi_e$	$I_F = 20\text{ mA}$	$TK_{\phi_e}$	-	-0.8	-	%/K
Angle of half intensity		$\phi$	-	$\pm 15$	-	$^{\circ}$
Peak wavelength	$I_F = 100\text{ mA}$	$\lambda_p$	-	950	-	nm
Spectral bandwidth	$I_F = 100\text{ mA}$	$\Delta\lambda$	-	50	-	nm
Temperature coefficient of $\lambda_p$	$I_F = 100\text{ mA}$	$TK_{\lambda_p}$	-	0.2	-	nm/K
Rise time	$I_F = 100\text{ mA}$	$t_r$	-	800	-	ns
	$I_F = 1.5\text{ A}$	$t_r$	-	400	-	ns
Fall time	$I_F = 100\text{ mA}$	$t_f$	-	800	-	ns
	$I_F = 1.5\text{ A}$	$t_f$	-	400	-	ns
Virtual source diameter		$d$	-	3.8	-	mm



TYPE DEDICATED CHARACTERISTICS ( $T_{amb} = 25\text{ }^{\circ}\text{C}$ , unless otherwise specified)							
PARAMETER	TEST CONDITION	PART	SYMBOL	MIN.	TYP.	MAX.	UNIT
Forward voltage	$I_F = 1.5\text{ A}$ , $t_p = 100\text{ }\mu\text{s}$	TSUS5200	$V_F$	-	2.2	3.4	V
		TSUS5201	$V_F$	-	2.2	3.4	V
		TSUS5202	$V_F$	-	2.2	2.7	V
Radiant intensity	$I_F = 100\text{ mA}$ , $t_p = 20\text{ ms}$	TSUS5200	$I_e$	10	20	50	mW/sr
		TSUS5201	$I_e$	15	25	50	mW/sr
		TSUS5202	$I_e$	20	30	50	mW/sr
	$I_F = 1.5\text{ A}$ , $t_p = 100\text{ }\mu\text{s}$	TSUS5200	$I_e$	95	180	-	mW/sr
		TSUS5201	$I_e$	120	230	-	mW/sr
		TSUS5202	$I_e$	170	280	-	mW/sr
Radiant power	$I_F = 100\text{ mA}$ , $t_p = 20\text{ ms}$	TSUS5200	$\phi_e$	-	13	-	mW
		TSUS5201	$\phi_e$	-	14	-	mW
		TSUS5202	$\phi_e$	-	15	-	mW

**BASIC CHARACTERISTICS** ( $T_{amb} = 25\text{ }^{\circ}\text{C}$ , unless otherwise specified)

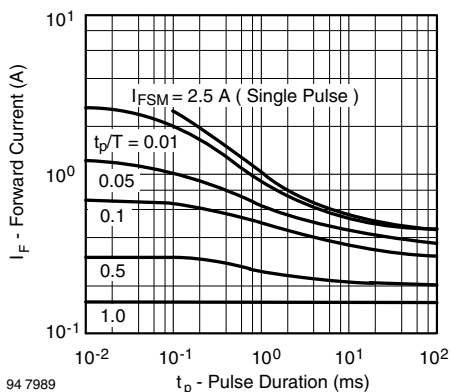

Fig. 3 - Pulse Forward Current vs. Pulse Duration

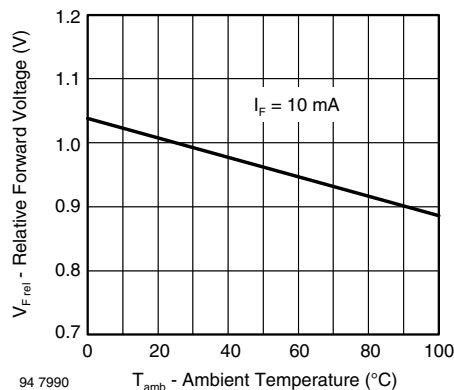

Fig. 5 - Relative Forward Voltage vs. Ambient Temperature

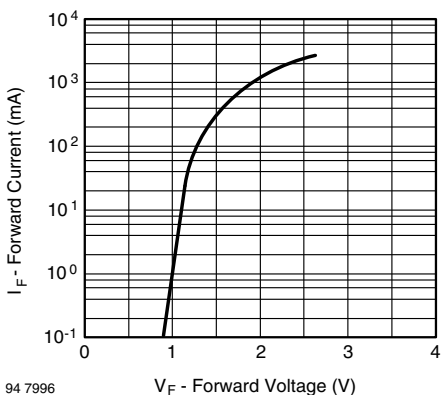

Fig. 4 - Forward Current vs. Forward Voltage

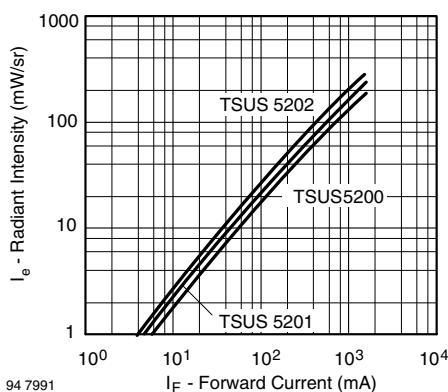

Fig. 6 - Radiant Intensity vs. Forward Current

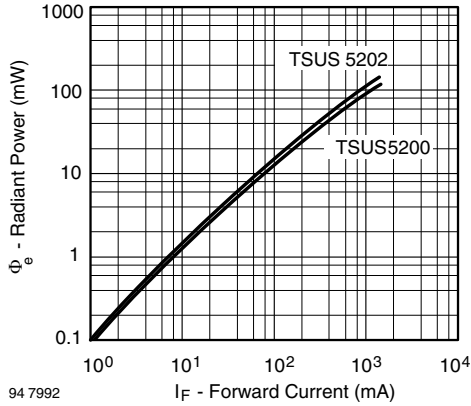

Fig. 7 - Radiant Power vs. Forward Current

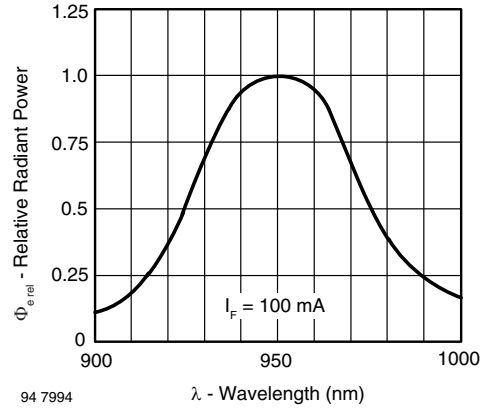

Fig. 9 - Relative Radiant Power vs. Wavelength

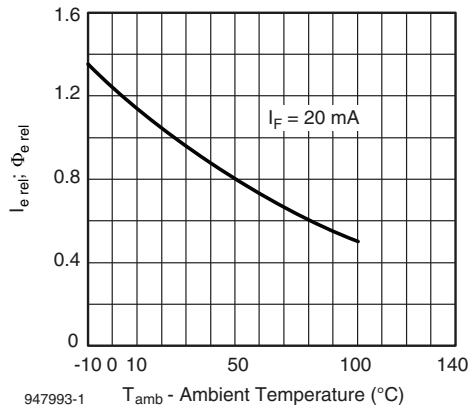

Fig. 8 - Relative Radiant Intensity/Power vs. Ambient Temperature

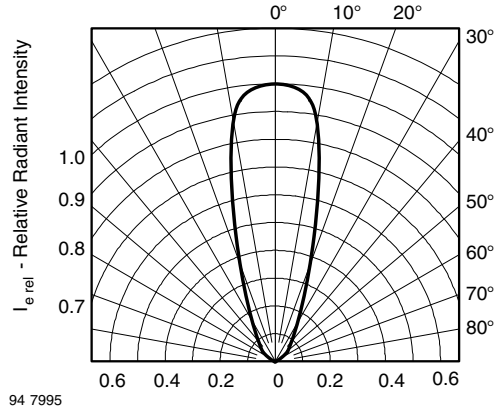
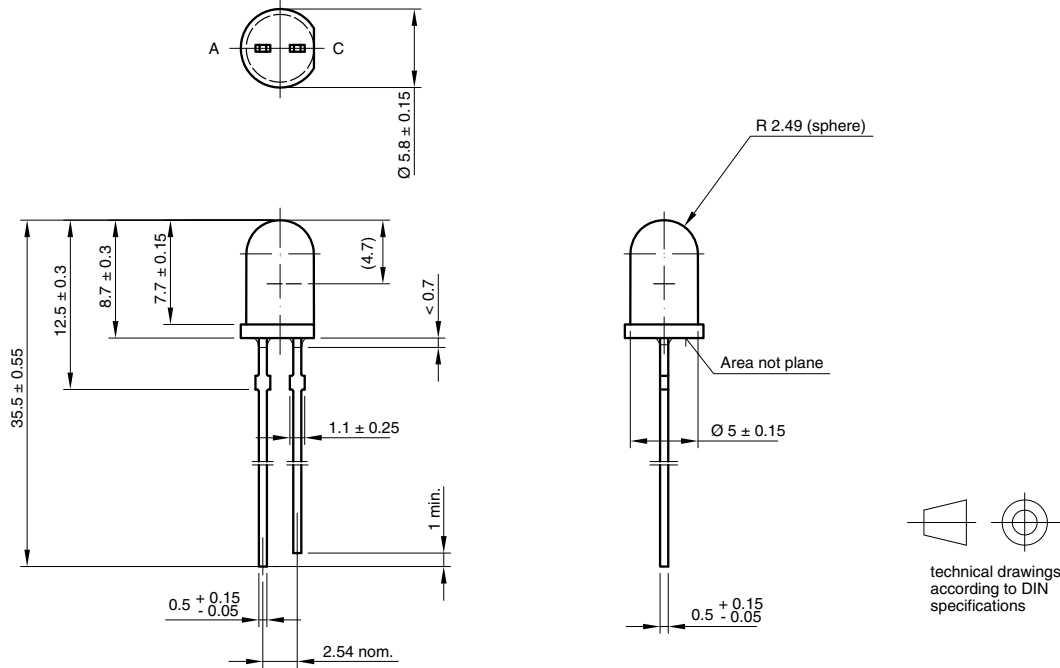

Fig. 10 - Relative Radiant Intensity vs. Angular Displacement



**PACKAGE DIMENSIONS** in millimeters



6.544-5258.02-4  
Issue: 7; 23.07.10  
95 10916



## **Disclaimer**

ALL PRODUCT, PRODUCT SPECIFICATIONS AND DATA ARE SUBJECT TO CHANGE WITHOUT NOTICE TO IMPROVE RELIABILITY, FUNCTION OR DESIGN OR OTHERWISE.

Vishay Intertechnology, Inc., its affiliates, agents, and employees, and all persons acting on its or their behalf (collectively, "Vishay"), disclaim any and all liability for any errors, inaccuracies or incompleteness contained in any datasheet or in any other disclosure relating to any product.

Vishay makes no warranty, representation or guarantee regarding the suitability of the products for any particular purpose or the continuing production of any product. To the maximum extent permitted by applicable law, Vishay disclaims (i) any and all liability arising out of the application or use of any product, (ii) any and all liability, including without limitation special, consequential or incidental damages, and (iii) any and all implied warranties, including warranties of fitness for particular purpose, non-infringement and merchantability.

Statements regarding the suitability of products for certain types of applications are based on Vishay's knowledge of typical requirements that are often placed on Vishay products in generic applications. Such statements are not binding statements about the suitability of products for a particular application. It is the customer's responsibility to validate that a particular product with the properties described in the product specification is suitable for use in a particular application. Parameters provided in datasheets and / or specifications may vary in different applications and performance may vary over time. All operating parameters, including typical parameters, must be validated for each customer application by the customer's technical experts. Product specifications do not expand or otherwise modify Vishay's terms and conditions of purchase, including but not limited to the warranty expressed therein.

Except as expressly indicated in writing, Vishay products are not designed for use in medical, life-saving, or life-sustaining applications or for any other application in which the failure of the Vishay product could result in personal injury or death. Customers using or selling Vishay products not expressly indicated for use in such applications do so at their own risk. Please contact authorized Vishay personnel to obtain written terms and conditions regarding products designed for such applications.

No license, express or implied, by estoppel or otherwise, to any intellectual property rights is granted by this document or by any conduct of Vishay. Product names and markings noted herein may be trademarks of their respective owners.