

3000A AC Flexible Clamp Adaptors

Models CA3010 and CA3018

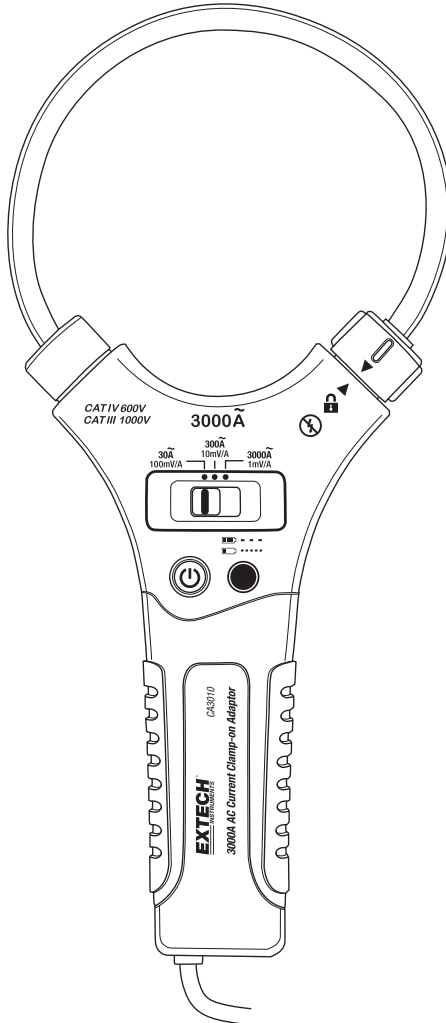

Introduction

Thank you for choosing the Extech AC Flexible Clamp Adaptor that can measure up to 3000A AC. A standard Digital MultiMeter (DMM) in mV AC mode can be used to display the current measurement when the CA series Adaptor is connected to the DMM.

The CA3018 is the 18" (45.7cm) clamp version and the CA3010 is the 10" (25.4cm) clamp version, otherwise both meters are the same. These devices are professional CAT IV 600V CAT III 1000V instruments. This meter is shipped fully tested and calibrated and, with proper use, will provide years of reliable service.

Features

- 3000A AC Current Measurements displayed on connected DMM
- Convenient Flexible Clamp with locking mechanism
- 7.5mm (0.3") coil diameter for measuring in tight spaces
- Supplied banana plug cables
- Power button
- Battery status LED indicator
- Current AC Range select switch 30A, 300A, 3000A
- Battery powered

Safety Information

To ensure the safe operation and service of the meter, follow these instructions closely. Failure to observe warnings can result in severe injury.



WARNINGS









WARNINGS identify hazardous conditions and actions that could cause BODILY HARM or DEATH.

- Individual protective equipment should be used if HAZARDOUS LIVE parts in the installation where measurements are to be carried out could be accessible.
- If the equipment is used in a manner not specified by the manufacturer, the protection provided by the equipment may be impaired.
- Always use proper terminals, switch position, and range for measurements.
- To reduce the risk of fire or electric shock, do not expose this product to rain or moisture.
- Verify the meter operation by measuring a known current. If in doubt, have the meter serviced.
- Do not apply more than the rated voltage/current as marked on the meter.
- To avoid false readings that can lead to electric shock and injury, replace battery as soon as the low battery indicator appears.
- Do not use the meter in or around explosive gas or vapor.
- Do not use a flexible current sensor if the inner copper wire of the flexible cord is visible.
- De-energize the installation under test or wear suitable protective clothing when placing or removing the flexible current probe from a test setup.
- Do not apply/remove the flexible current probe to/from UNINSULATED HAZARDOUS LIVE conductors which may cause electric shock, electric burn, or arc flash.

CAUTIONS

CAUTIONS identify conditions and actions that could cause DAMAGE to the meter or equipment under test. Do not expose the meter to extremes in temperature or high humidity.

Safety Symbols that are typically marked on meters and instructions

	This symbol, adjacent to another symbol, indicates the user must refer to the manual for further information.
	Do not apply or remove clamp from HAZARDOUS LIVE conductors
	Equipment protected by double or reinforced insulation
	Battery symbol
	Conforms to EU directives
	Do not discard this product in household trash.
	AC measurement
	Earth ground

PER IEC1010 OVERVOLTAGE INSTALLATION CATEGORY

OVERVOLTAGE CATEGORY I

Equipment of OVERVOLTAGE CATEGORY I is equipment for connection to circuits in which measures are taken to limit the transient over-voltages to an appropriate low level.

Note – Examples include protected electronic circuits.

OVERVOLTAGE CATEGORY II

Equipment of OVERVOLTAGE CATEGORY II is energy-consuming equipment to be supplied from the fixed installation.

Note – Examples include household, office, and laboratory appliances.

OVERVOLTAGE CATEGORY III

Equipment of OVERVOLTAGE CATEGORY III is equipment in fixed installations.

Note – Examples include switches in the fixed installation and some equipment for industrial use with permanent connection to the fixed installation.

OVERVOLTAGE CATEGORY IV

Equipment of OVERVOLTAGE CATEGORY IV is for use at the origin of the installation.

Note – Examples include electricity meters and primary over-current protection equipment

Description

Meter Description

1. Flexible Current Clamp
2. Range selector
3. Power button
4. Banana Plug cable
5. Battery Compartment
6. Battery status indicator
7. Clamp Lock mechanism
8. Test Lead Banana Plugs

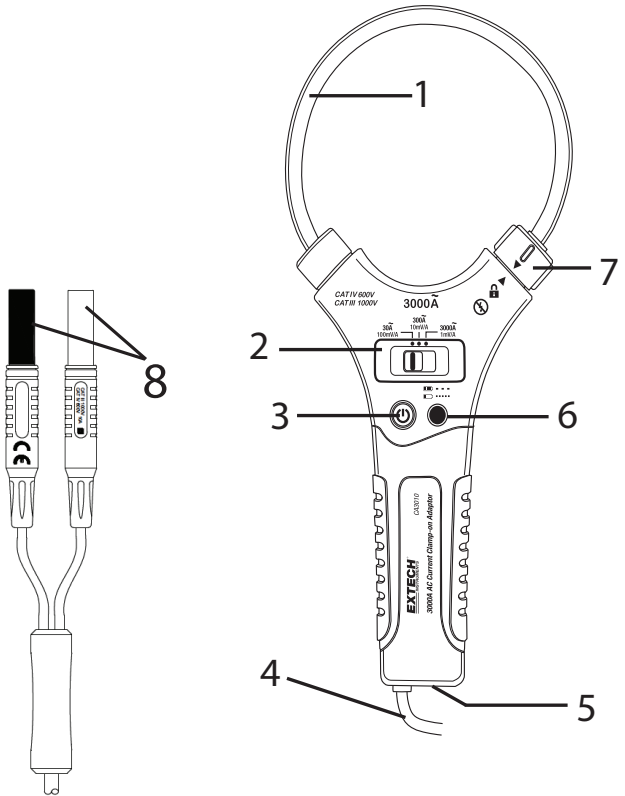

Operation

NOTES: Read and understand all **Warning** and **Caution** statements in this operation manual prior to using this meter.

Meter Power

The meter is powered by two (2) AAA 1.5V batteries (located in compartment on bottom of meter handle). Press the Power button momentarily to switch the device ON or OFF.

Battery status indication

The battery status indicator blinks slowly when the battery is fresh ($> 2.5V$). The indicator blinks quickly when the battery is weakening ($< 2.5V$) and requires changing. Refer to the Maintenance section for details on battery replacement.

AC Current Measurements

WARNING: Ensure that power to the device under test is OFF before starting this procedure. Switch power to the device under test ON only after the clamp has been safely attached to the device under test.



CAUTION: Do not move fingers above the LCD at any time during a test.

1. Switch OFF the Clamp Adaptor, the DMM, and the device under test.
2. Connect the Clamp Adaptor to the DMM banana jacks using the supplied banana plugs.
3. Switch ON the DMM and set the DMM to the AC V mode.
4. Set the Range Select switch on the Clamp Adaptor to the expected current range measurement.
5. Turn the knurled clamp lock mechanism on the Clamp Adaptor counter-clockwise to release the flexible clamp.
6. Fully enclose only one conductor of the device under test with the flexible clamp probe (see accompanying diagrams). Do not attempt to measure current higher than the specified current limit.
7. Switch the Clamp adaptor ON (press Power button) and then switch the device under test ON. Never move fingers above the LCD when running a test.
8. Read the current value in the DMM display.
9. Remove power to the device under test before removing the Flexible Clamp connection and disconnecting the application setup.

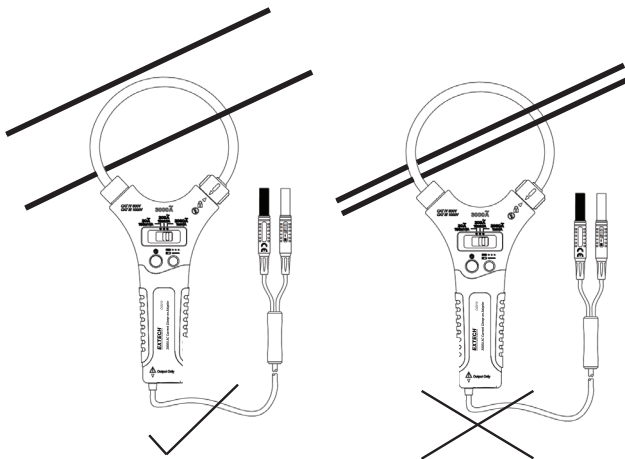

Range Selection Guide

For the best results, with regard to output signal, select the correct range according to expected current measurement. See Table below.

Range Select Switch	Best Performance
30A (100mV/1A)	30.00A max.
300A (10mv/1A)	30.0 to 300.0 A
3000A (1mV/1A)	300.0 to 3000A

Maintenance

WARNING: To avoid electrical shock, disconnect the meter from any circuit and turn OFF the meter before opening the case. Do not operate the meter with an open case.

Cleaning and Storage

Periodically wipe the case with a damp cloth and mild detergent; do not use abrasives or solvents. If the meter is not to be used for 60 days or more, remove the batteries and store them separately.

Battery Replacement

 **CAUTION:** Remove the meter from the conductor under test and switch the meter OFF before opening the battery compartment.

1. With a flat blade screwdriver or coin, rotate the battery compartment cover to the unlock position.
2. Remove the battery compartment cover.
3. Replace the 2 'AAA' 1.5V batteries observing correct polarity. Positive side of both batteries insert first.
4. Re-attach the battery compartment cover.
5. Rotate the battery compartment cover to the lock position.



You, as the end user, are legally bound (**EU Battery ordinance**) to return all used batteries, **disposal in the household garbage is prohibited!** You can hand over your used batteries / accumulators at collection points in your community or wherever batteries accumulators are sold!

Disposal: Follow the valid legal stipulations in respect of the disposal of the device at the end of its lifecycle

Specifications

Function	Range	Output Voltage	Accuracy
AC Current	30.00 A AC	100mV/1A AC	± (3.0% of Full Scale) for frequency range: 45~500Hz
	300.0A AC	10mV/1A AC	
	3000 A AC	1mV/1A AC	

Notes:

Accuracy is given as \pm (% of reading + least significant counts) at 23°C \pm 5°C with relative humidity lower than 80%. Accuracy is specified for a period of one year after calibration.

Max. Output Voltage: 4.5V peak

Output Noise: < 5mV for each range

Position Error of Clamp: Accuracy and position error assumes centralized primary conductor at optimum position, no external electrical or magnetic field, and within operating temperature range.

	CA3010	CA3010 Error*	CA3018	CA3018 Error*
Distance from optimum position	15mm (0.6")	+2.0%	35mm (1.4")	+1.0%
	25mm (1.0")	+2.5%	50mm (2.0")	+1.5%
	35mm (1.4")	+3.0%	60mm (2.4")	+2.0%

*Add this error to the AC Current accuracy specification listed earlier in this section.

GENERAL SPECIFICATIONS

Clamp Jaw	Flexible type with locking mechanism and 7.5mm (0.3") coil diameter
Battery status indication	LED indicator blinks slowly (battery power > 2.5V) or quickly (battery power < 2.5V)
AC bandwidth	45 to 500Hz (sine wave)
Operating Temperature and Humidity	
	0~30°C (32~86°F); 80%RH maximum
	30~40°C (86~104°F); 75%RH maximum
	40~50°C (104~122°F); 45%RH maximum
Storage Temperature and Humidity	
	-20°~60°C (-4°~140°F); 80%RH maximum
Temperature Coefficient	0.2 x specified accuracy / °C, < 18°C (64.5°F), > 28°C (82.4°F)
Altitude	Maximum operating altitude 2000m (6562')
Battery	Two "AAA" 1.5V batteries
Battery life	160 hours with alkaline batteries
Dimensions (W x H x D)	CA3010: 120 x 280 x 25 mm (4.7 x 11.0 x 1.0") CA3018: 130 x 350 x 25 mm (5.1 x 13.8 x 1.0")
Weight	CA3010: 170 g (6.0 oz.) CA3018: 200 g (7.1 oz.)
Safety Standards	For indoor use and in accordance with the requirements for double insulation to EN61010-1, EN61010-2-032, EN61326-1; CAT IV 600V, CAT III 1000V, Pollution Degree 2
Shock Vibration	Sinusoidal vibration MIL-PRF-28800F (5-55 Hz, 3g max.)
Drop Protection	1.2m (4') drop onto hard wood or concrete floor

Copyright © 2015 FLIR Systems, Inc.

Reservados todos los derechos, incluyendo el derecho de reproducción total o parcial en cualquier medio

www.extech.com