

FP1008R1 and FP1008R2

High frequency, high current power inductors



Applications

- Servers
 - Multi-phase and Vcore regulators
 - Voltage Regulator Modules (VRMs)
- Desktop VRMs and EVRDs
- Data networking and storage systems
- Graphics cards and battery power systems
- Point-of-Load modules
- DCR Sensing circuits

Environmental data

- Storage temperature range (Component): -40°C to +125 °C
- Operating temperature range: -40°C to +125°C (ambient + self-temperature rise)
- Solder reflow temperature: J-STD-020D compliant

Product description

- High current carrying capacity
- Low core loss
- Controlled DCR for sensing circuits
- Inductance range from 120nH to 300nH
- Current range from 38 to 112 amps
- 10.8 x 8.5 mm footprint surface mount package in an 8.0 mm height
- Ferrite core material
- Halogen free, lead free, RoHS compliant



Product specifications

Part Number ⁹	OCL ¹ (nH)±10%	FLL ² (nH) minimum	I _{rms} ³ (amps)	I _{sat} 1 ⁴ (amps)	I _{sat} 2 ⁵ (amps)	I _{sat} 3 ⁶ (amps)	DCR (mΩ) ±5% @ 20°C	K-factor ⁷
R1 version								
FP1008R1-R120-R	120	86	79	112	92	84	0.17	342
FP1008R1-R150-R	150	108	79	90	72	67	0.17	342
FP1008R1-R180-R	180	130	79	74	60	54	0.17	342
FP1008R1-R220-R	220	158	79	56	44	42	0.17	342
FP1008R1-R270-R	270	194	79	44	34	32	0.17	342
FP1008R1-R300-R	300	216	79	38	30	28	0.17	342
R2 version								
FP1008R2-R120-R	120	86	74	112	92	84	0.18	342
FP1008R2-R150-R	150	108	74	90	72	67	0.18	342
FP1008R2-R180-R	180	130	74	74	60	54	0.18	342
FP1008R2-R220-R	220	158	74	56	44	42	0.18	342
FP1008R2-R270-R	270	194	74	44	34	32	0.18	342
FP1008R2-R300-R	300	216	74	38	30	28	0.18	342

- Open Circuit Inductance (OCL) Test Parameters: 100kHz, 0.1V_{rms}, 0.0Adc, +25°C
- Full Load Inductance (FLL) Test Parameters: 100kHz, 0.1V_{rms}, I_{sat}1, +25°C
- I_{rms}: DC current for an approximate temperature rise of 40°C without core loss. Derating is necessary for AC currents. PCB layout, trace thickness and width, air-flow, and proximity of other heat-generating components will affect the temperature rise. It is recommended that the temperature of the part not exceed 125°C under worst case operating conditions verified in the end application.
- I_{sat}1: Peak current for approximately 20% rolloff @ +25°C
- I_{sat}2: Peak current for approximately 20% rolloff @ +100°C
- I_{sat}3: Peak current for approximately 20% rolloff @ +125°C
- K-factor: Used to determine B_{avg} for core loss (see graph).
B_{avg} = K * L * ΔI * 10⁻³ / 2π (Gauss), K: (K factor from table),
L (Inductance in nH), ΔI (Peak-to-peak ripple current in Amps).
- Part Number Definition: FP1008Rx-Rxxx-R
FP1008R - Product code and size
x = DCR indicator
Rxx = Inductance value in μH, R = decimal point
R suffix = RoHS compliant

Dimensions (mm)

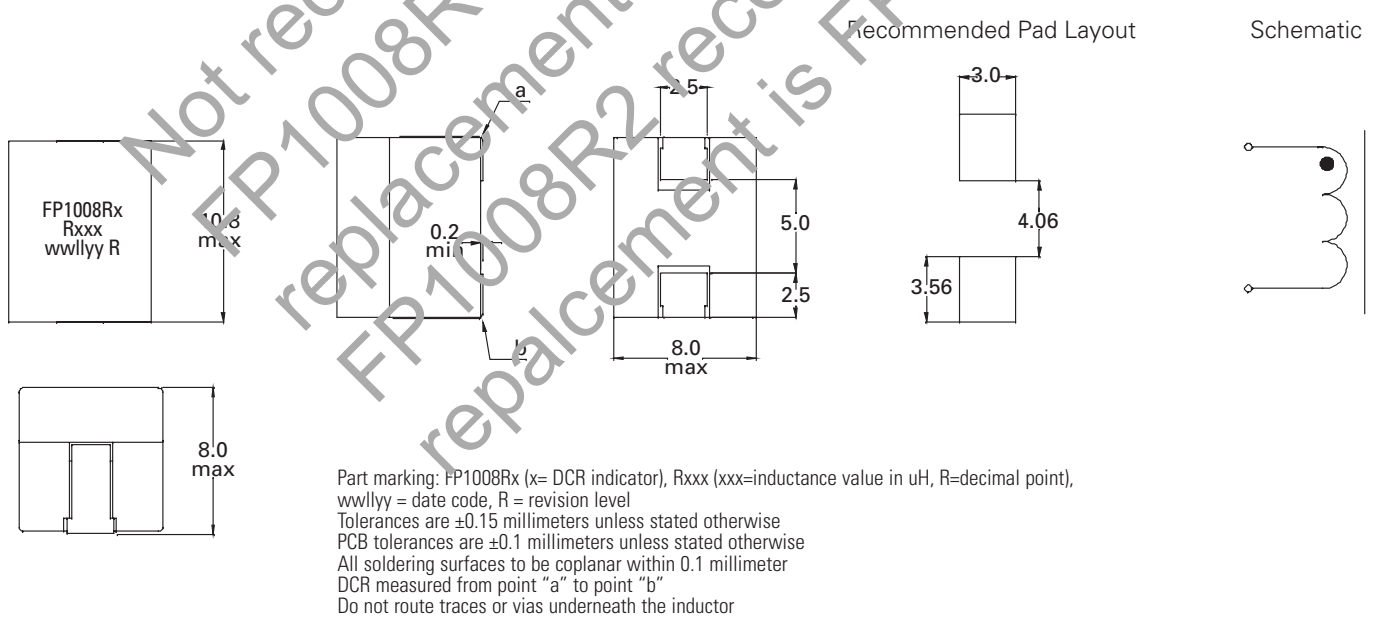

Packaging information (mm)

Supplied in tape and reel packaging, 500 parts per 13" diameter reel.

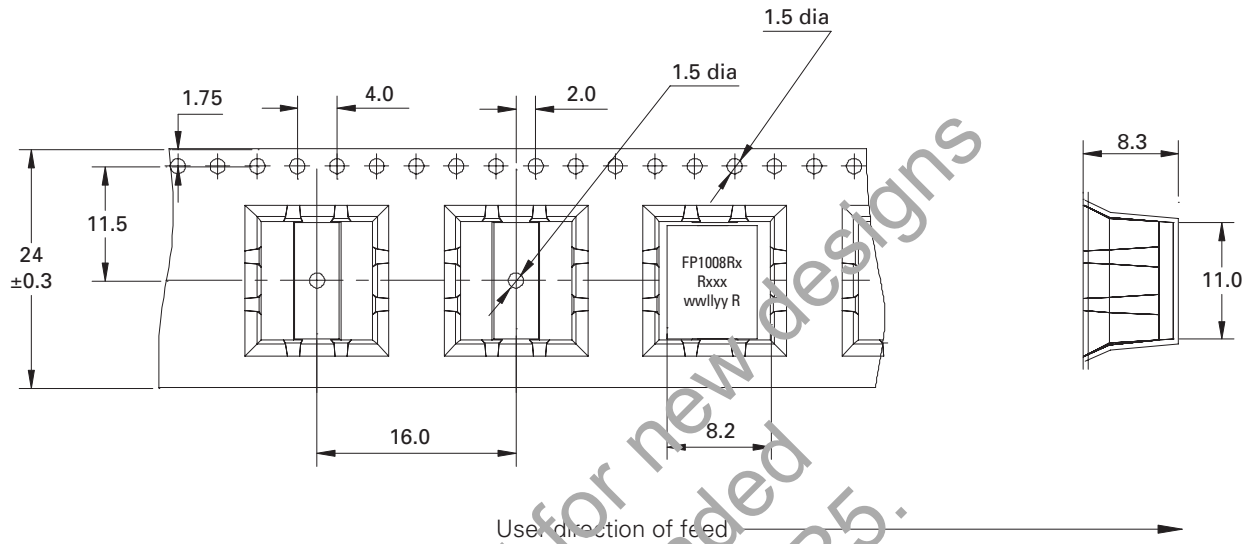

Temperature rise vs. total loss

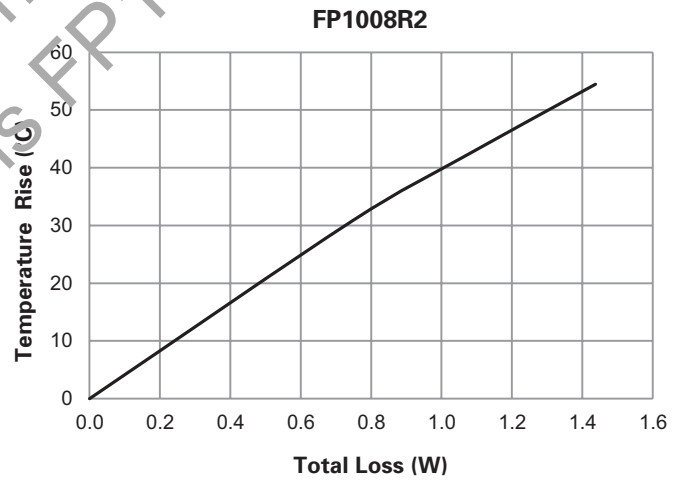
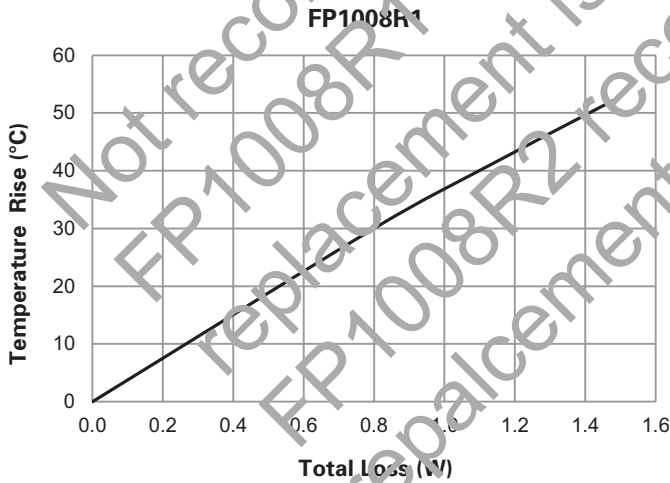

Core loss vs. Bp-p

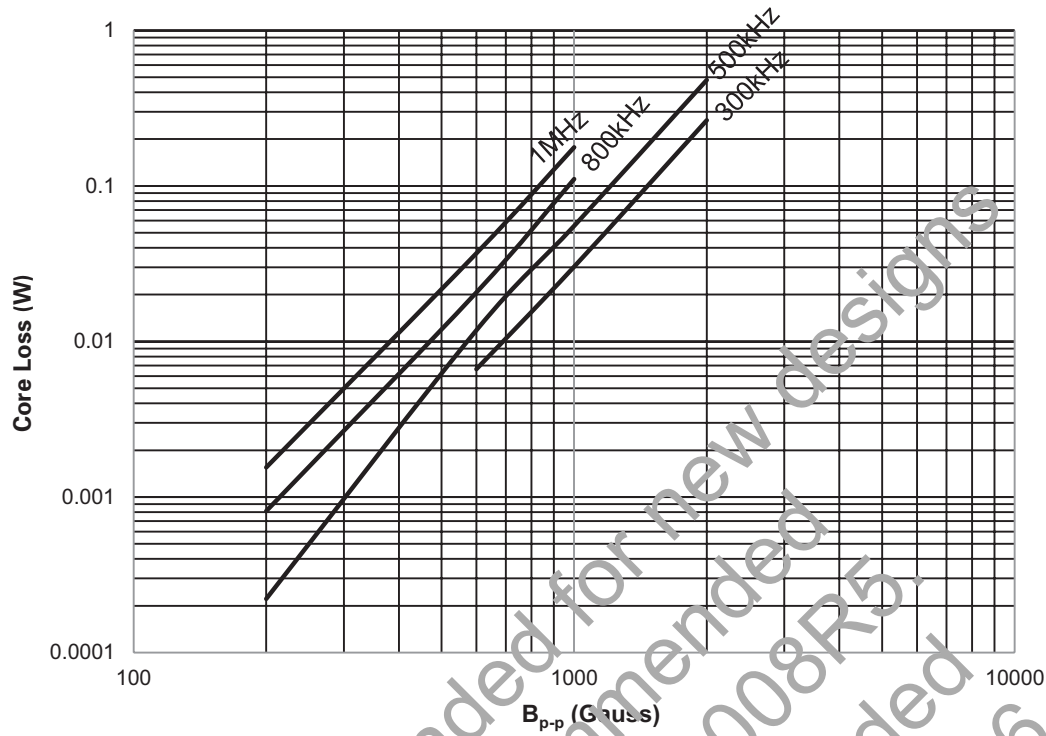

Inductance characteristics

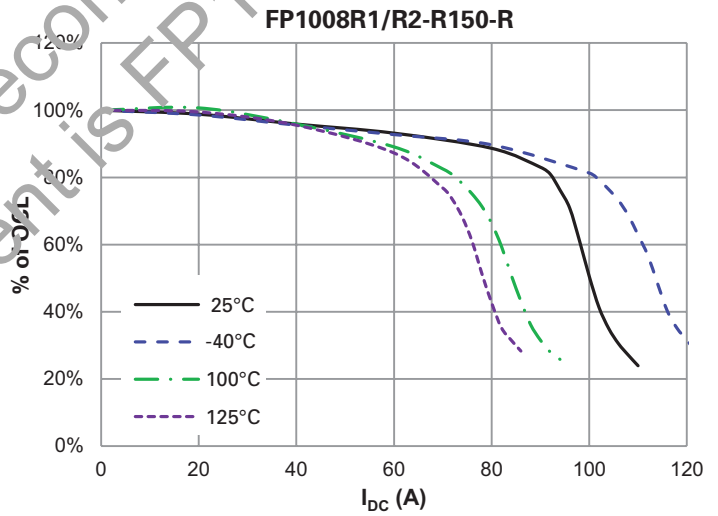
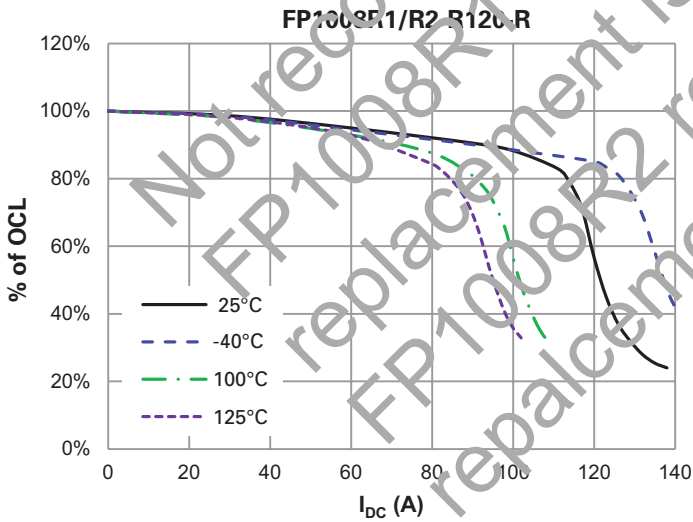

Inductance characteristics

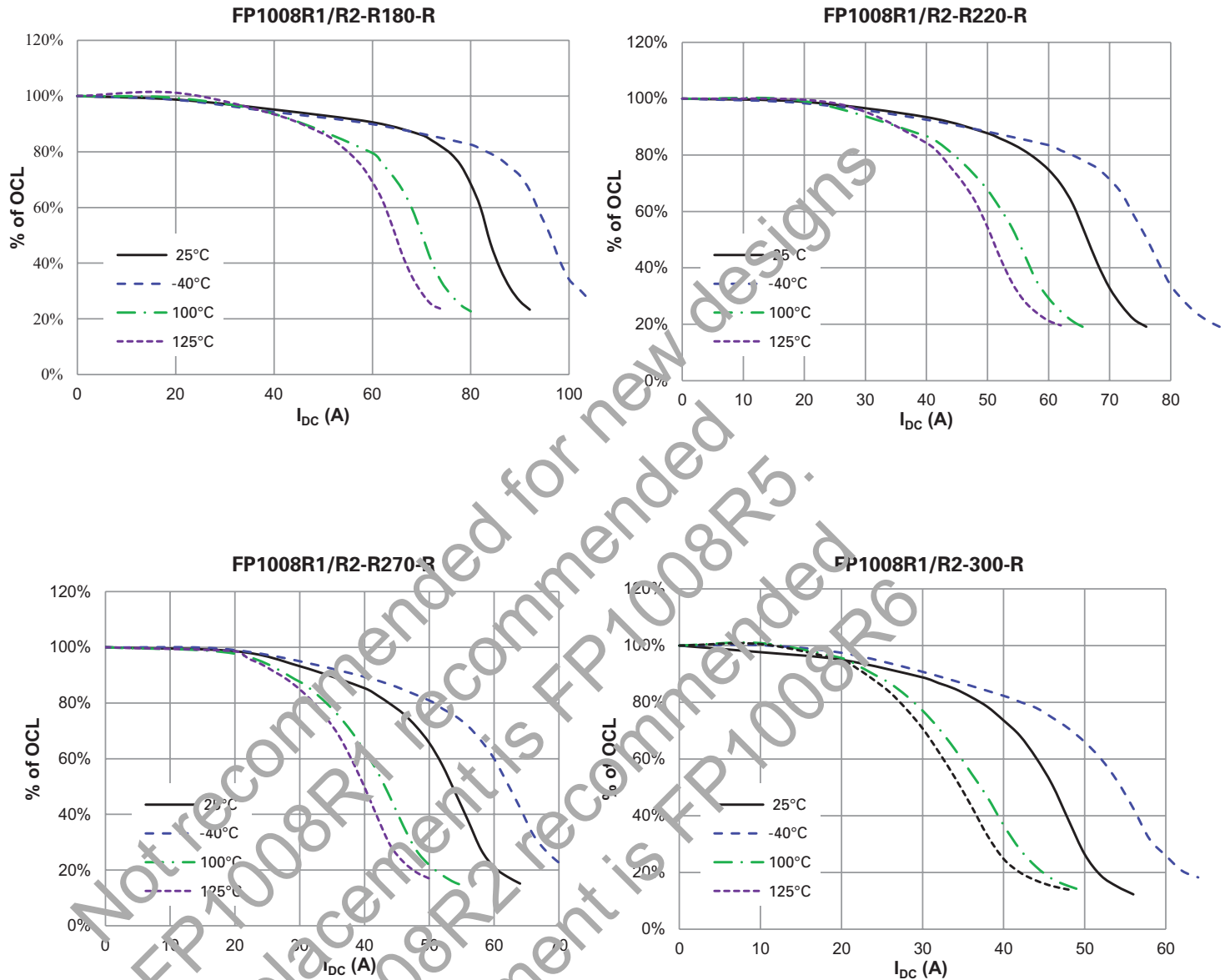

Solder reflow profile

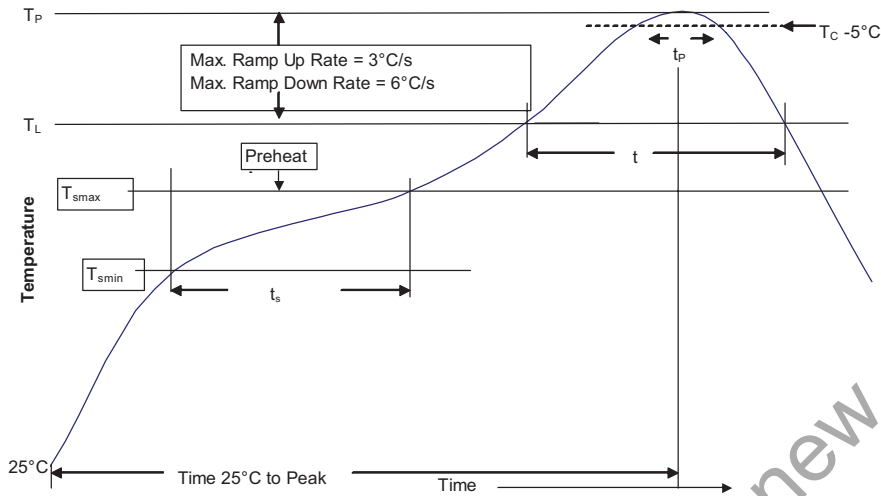

Table 1 - Standard SnPb Solder (T_c)

Package Thickness	Volume mm^3 <350	Volume mm^3 \geq 350
<2.5mm)	235°C	220°C
\geq 2.5mm	220°C	220°C

Table 2 - Lead (Pb) free Solder (T_c)

Package Thickness	Volume mm^3 <350	Volume mm^3 350 - 2000	Volume mm^3 >2000
<1.6mm	260°C	260°C	260°C
1.6 - 2.5mm	260°C	250°C	245°C
>2.5mm	250°C	245°C	245°C

Reference JDEC J-STD-020D

Profile Feature	Standard SnPb Solder	Lead (Pb) Free Solder
Preheat and Soak		
• Temperature min. (T_{smin})	100°C	150°C
• Temperature max. (T_{smax})	150°C	200°C
• Time (T_{smin} to T_{smax}) (t_s)	60-120 Seconds	60-120 Seconds
Average ramp up rate T_{smax} to T_p	3°C/ Second Max.	3°C/ Second Max.
Liquidous temperature (T_l)	183°C	217°C
Time at liquidous (t_l)	60-150 Seconds	60-150 Seconds
Peak package body temperature (T_p)*	Table 1	Table 2
Time (t_p)** within 5 °C of the specified classification temperature (T_c)	20 Seconds**	30 Seconds**
Average ramp-down rate (T_p to T_{smax})	6°C/ Second Max.	6°C/ Second Max.
Time 25°C to Peak Temperature	6 Minutes Max.	8 Minutes Max.

* Tolerance for peak profile temperature (T_p) is defined as a supplier minimum and a user maximum.
** Tolerance for time at peak profile temperature (t_p) is defined as a supplier minimum and a user maximum.

Life Support Policy: Eaton does not authorize the use of any of its products for use in life support devices or systems without the express written approval of a manager of the Company. Life support systems are devices which support or sustain life, and whose failure to perform, when properly used in accordance with instructions for use provided in the labeling, can be reasonably expected to result in significant injury to the user.

Eaton reserves the right, without notice, to change design or construction of any products and to discontinue or limit distribution of any products. Eaton also reserves the right to change or update, without notice, any technical information contained in this bulletin.

Eaton
Electronics Division
1000 Eaton Boulevard
Cleveland, OH 44122
United States
www.eaton.com/elx

© 2015 Eaton
All Rights Reserved
Printed in USA
Publication No. 10408-BU-SB15269
June 2015

Eaton is a registered trademark.

All other trademarks are property of their respective owners.