

[Maxim](#) > [Design Support](#) > [Technical Documents](#) > [Tutorials](#) > [Basestations/Wireless Infrastructure](#) > APP 5429

[Maxim](#) > [Design Support](#) > [Technical Documents](#) > [Tutorials](#) > [High-Speed Signal Processing](#) > APP 5429

[Maxim](#) > [Design Support](#) > [Technical Documents](#) > [Tutorials](#) > [Wireless and RF](#) > APP 5429

Keywords: IP3, IPn, IIP3, OIP3, IIPn, OIPn, linearity, intercept point, intermodulation, harmonics, image frequency, compression point, LNA, VGA, mixer, downconverter, upconverter

TUTORIAL 5429

The IP3 Specification - Demystified

By: Kuo-Chang Chan, Director of Field Applications Engineering in Southern Europe

Mar 12, 2013

Abstract: IP3 is a well-known parameter that gauges linearity in radio frequency (RF) functions and components. This tutorial will use basic math and graphics to explain how IP3 is generated and how its values are linked to essential quantities, such as the input and output powers of a device. It will explain why high IP3 (thus, high linearity) is so important when evaluating high performance. Finally, it will discuss some high-performance analog ICs in which linearity, high IP3, is a fundamental measurement of their good operation.

A similar version of this article appeared on [EDN](#), June 29, 2012.

Introduction

This article will explain the origin and purpose of intercept point (IP) specifications. These specifications are called simply IPn, which indicates "intercept points of order n," where n is an integer starting from 2. The IPn are indicators of good linearity in an electronic device such as a low-noise amplifier (LNA), radio frequency (RF) mixer, or power amplifier (PA).

Since IPn consists of "virtual" parameters (i.e., the values are actually defined from other specs), their values and extrapolations often remain vague. Admittedly, many electronic books or tutorials give some description of how IPn specs are linked with input/output powers, power gain, and compression points. However, those reference works offer minimal, none, or incomplete explanations about IPn specs and their origin.

Today integrated functions such as an LNA, mixers, and a VCO can be built with the highest linearity (thus superior IP3), with advanced design techniques, and with proven RF processes like silicon-germanium (SiGe) technologies. The design aim is to obtain highest IP3 without sacrificing current consumption (bias circuit), gain, and size. Practically speaking, describing IPn orders up to 5, and eventually 7, can be significant. Today, however, the "order 3" (IP3) dominates when describing the normal operation of sensitive devices.

This tutorial will use basic math and graphics to explain how IPn, and especially IP3, is generated and



[Click here](#) for an overview of the wireless components used in a typical radio transceiver.

how its values are linked to essential quantities, such as the input and output powers of a device. It will explain why high IP3 (thus, high linearity) is so important when evaluating high performance. Finally, it will discuss some high-performance analog ICs in which linearity, high IP3, is a fundamental measurement of their good operation.

Why Is Linearity So Important?

A principal objective for many electronic devices has been always to replicate simple, easy-to-reproduce, ideal mathematical functions. A simple illustration is the resistor which is designed to reproduce a linear relationship between voltage and current (VI). The resistor is simply the slope of the VI response.

We all know that the ideal relationship of $V = R \times I$ cannot be realized 100% of the time. One can approach it, but the inherent imperfections and limitations of the devices cause deviations in the ideal curve. This is particularly true when signals (I, V) are large and/or other conditions like temperature, humidity, and pressure vary. To compensate for these inherent deviations, we want the resistor, R, to be as linear as possible and remain so over wide ranges of signals and conditions. In reality, however, resistors have more complex curves in the (VI) characteristics (red dotted line in **Figure 1**).

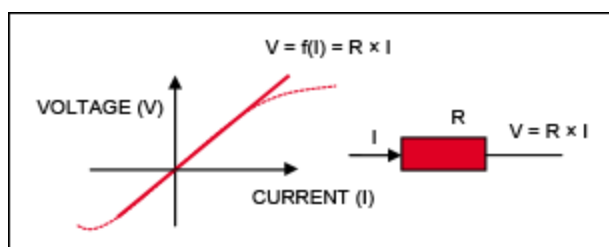

Figure 1. Dotted red line shows the real (imperfect) resistor. Linearity is corrupted when I and V curves become large.

Other IC components that require well-controlled linearity include amplifiers, data converters, VCOs, mixers, and power amplifiers. With these ICs, deviations from the ideal VI relationship lead to instabilities, failure to meet specs, and interferences. It can even cause malfunctions or destroy the device and/or entire system.

Measuring Linearity

Depending on the class of signals and their dynamic ranges, different parameters and methods are defined to visualize, evaluate, measure, and compare the linear characteristic of an actual device.

Resistor linearity is typically measured in % of a nominal value of R. This is usually enough to appreciate the error that one introduces in current and voltage on the device.

The RF functions in an LNA, mixers, filters, PA, and other components can generate very large signal dynamics and introduce harmonics, interferences, and saturation as critical effects of nonlinearities. Several parameters have been defined to characterize this nonideal relationship between input and output:

- 1dB compression point (CP-1dB)
- Compression dynamic range (CDR)

- Spurious-free dynamic range (SFDR)
- Desensitization dynamic range (DDR)
- Intercept points (IPn)

Since all the above terms indicate how good (or bad) the linearity of a device is, relations do exist between them. While this examination acknowledges the above class of parameters, it focuses exclusively on the intercept points, or how IPn (n) can be 2, 3, 4, etc. It will become clear that IPn (especially IP3) reveals the most about how nonlinearity negatively affects useful signals. It causes interferences to be directly injected in the desired signal bandwidth. For this reason, one can focus here only on IP3 performance, regardless of the other parameters. Thus, in a few words, the higher the IPn, the more linear is the device.

Nonlinearity Causes Harmonics and Intermodulations (IMn)

We begin by considering a general electronic function. Signals x and y are the input and output powers, respectively, and A is the transfer function between them (i.e., the "gain" if the device is an amplifier). Referring to the discussion of the resistor in Figure 1, in all real-world devices the curve is not a nice straight line indicating that "y is proportional to x." Instead, the curve is not perfect and becomes distorted when signals are large.

When x and y are small, the curve is close to a straight line, but not 100% straight. Whether or not the designer realizes it, there are nonlinearities. When x and y are large, however, the nonlinearities are highly visible. In general, the device saturates; the output cannot respond correctly to any further increase in the input signal. This phenomenon is better illustrated by the -1dB compression point which shows the upper limit of the applicable signals (i.e., the dynamic range) (**Figure 2**).

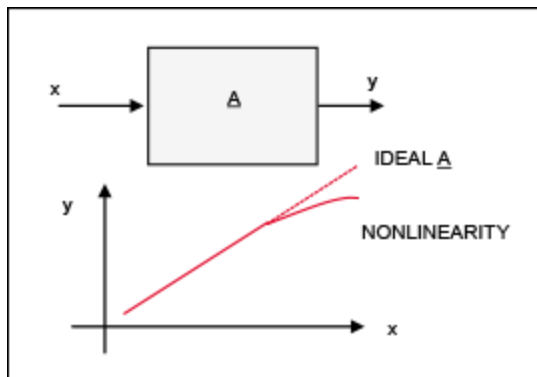

Figure 2. Figure shows nonlinearity versus ideal linearity behavior.

Generally speaking, one can write:

$$y = A_0 + A_1 \cdot x^1 + A_2 \cdot x^2 + A_3 \cdot x^3 + \dots + A_i \cdot x^i + \dots + A_n \cdot x^n \quad (\text{Eq. 1})$$

(Taylor series development of any transfer function A .)

For a pure linear function, we want $A_i = 0$ for all $i > 1$. Therefore:

$$y(\text{Linear}) = A_0 + A_1 \cdot x \quad (\text{Eq. 2})$$

Unfortunately, (you as you now know) this is never entirely so; the terms in x^2 , x^3 , x^4 etc. are present as well. Their magnitudes depend on the strength of A_2 , A_3 , A_4 etc., and they are responsible for the deviation of the transfer function A away from the desired, perfect, proportional law.

Assume now that we are in sinusoidal world where $x(t)$ is a sinewave signal. Here $x(t)$ contains only one frequency, ω . Therefore, by expressing it in a very general sinewave form:

$$X(t) = A \cos(\omega.t + \Phi) \quad (\text{Eq. 3})$$

By expressing $x(t)$ in its Euler form, we have $X(t) = A/2[e^{+j(\omega t + \Phi)} + e^{-j(\omega t + \Phi)}]$, which is a sum of two complex numbers. We will focus only on the first term of the sum for the further discussions. (This simplifies the equation manipulations, since only the exponential effects will be used in our demonstrations.)

Let's assume that the first term of the Euler form in $x(t)$ is:

$$x = K e^{j(\omega t + \Phi)} \quad (\text{Eq. 4})$$

If the device A is really linear, then its response y is a proportional image of x :

$$y = A_0 + A_1.x \quad (\text{Eq. 5})$$

$$y = A_0 + A_1.K e^{j(\omega t + \Phi)} \quad (\text{Eq. 6})$$

You see that y contains the same and unique frequency ω . We can draw an important conclusion from this: *a perfect linear function or device will never generate any other frequency by itself.*

There are two important observations to be made now.

1. x contains two frequencies: ω_a and ω_b .

It is easy to show that if the device is linear, it does not matter; y will reproduce exactly the same two original frequencies, ω_a and ω_b :

$$y = A_0 + A_1.(K_a e^{j(\omega_a t + \Phi_a)} + K_b e^{j(\omega_b t + \Phi_b)}) \quad (\text{Eq. 7})$$

There are no other frequencies generated!

2. x contains multiple frequencies: $\omega_a, \omega_b, \omega_c, \omega_d, \omega_n$

Again, if the device is linear, the output remains a nice image with no distortion of x . The same original frequencies (no more and no less) are found in y .

What Happens When the Device Is Not Linear?

We start our analysis with x containing only one frequency, ω :

$$y = A_0 + A_1.x^1 + A_2.x^2 + A_3.x^3 + \dots + A_i.x^i + \dots A_n.x^n \quad (\text{Eq. 8})$$

Therefore:

$$x = K e^{j(\omega t + \Phi)} \quad (\text{Eq. 9})$$

(Recall the math function: $(e^m)^n = e^{m.n}$.)

Where:

$$y = A_0 +$$

$$A_1. K e^{j(\omega t + \Phi)} + \quad (\text{contains } \omega)$$

$$A_2. (K e^{j(\omega t + \Phi)})^2 + \quad (\text{contains } 2\omega)$$

$$A_3. (K e^{j(\omega t + \Phi)})^3 + \quad (\text{contains } 3\omega)$$

$$A_i. (K e^{j(\omega t + \Phi)})^i + \quad (\text{contains } i.\omega)$$

Thus, the device has generated multiple frequencies that were not present in the input signal, x .

The fundamental is the term y with ω ; all the others, 2ω , 3ω , ... i . ω ,... n . ω (in fact, the integer multiple of ω) are called its harmonics. These harmonics are responsible for the signal distortion and noise.

At this stage, the situation is not that dramatic; the harmonics are (often) easy to filter out since their frequencies are relatively far from useful signals bands "glued" around the fundamental one (**Figure 3**).

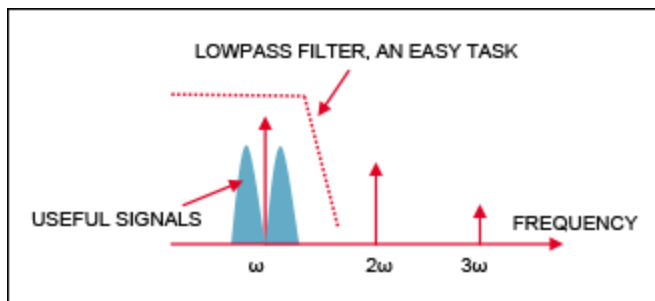

Figure 3. This figure shows the task for a lowpass filter in easy and more complex situations.

The real annoying problem comes when you combine a nonlinear device and input signal containing several frequencies. This is especially troublesome when you have a perturber close to the useful frequency. We will see what happens with two frequencies:

$$x = x_a + x_b \quad (\text{Eq. 10})$$

Where x_a has frequency ω_a and x_b has frequency ω_b . Here x is also called a two-tone signal.

By injecting this x in the general form, we get:

$$y = A_0 + A_1.x^1 + A_2.x^2 + A_3.x^3 + \dots + A_i.x^i + \dots A_n.x^n \quad (\text{Eq. 11})$$

We can develop each of the above terms:

- **Order-0 Product or Continuous Part: A_0**
- **First-Order Products or Linear Parts: $A_1.x$**

$$A_1 \times x = A_1.(x_a + x_b) \quad (\text{Eq. 12})$$

Equation 12 contains the two original frequencies, ω_a and ω_b , as expected.

- **Second-Order Products or Quadratic Parts: $A_2.x^2$**

$$A_2.x^2 = A_2.(x_a + x_b)^2 = A_2.(x_a^2 + x_b^2 + 2. x_a x_b) \quad (\text{Eq. 13})$$

The term x_a^2 contains frequency $2.\omega_a$, and the term x_b^2 contains frequency $2.\omega_b$. The 2 above are the harmonics. Note now that strange effects are also appearing: arithmetic combinations of the originals. They are called intermodulation products (IM).

Finally, the term $2. x_a x_b$ contains frequencies $\omega_a + \omega_b$ and $|\omega_a - \omega_b|$. If the original frequencies are in a similar band, the four above terms will be situated relatively far away and, thus, easy to eliminate (even with inexpensive filters). The mixtures between the original frequencies, $\omega_a + \omega_b$, $\omega_a - \omega_b$, and $\omega_b - \omega_a$ are also called second-order intermodulation products (IM2).

- **Third-Order Products: $A_3.x^3$**

By developing $(x_a + x_b)^3$, you will find x_a^3 , x_b^3 , $3x_a^2 x_b$, and $3x_a x_b^2$. Those will generate other intermodulation products with frequencies such as $3\omega_a$, $3\omega_b$, $2\omega_a + \omega_b$, $2\omega_a - \omega_b$, $\omega_a + 2\omega_b$, and $2\omega_a - \omega_b$. The mixtures between the original frequencies, $2\omega_a + \omega_b$, $2\omega_a - \omega_b$, and $2\omega_b - \omega_a$, are also called third-order intermodulation products (IM3).

While the terms $3\omega_a$, $3\omega_b$, $2\omega_a + \omega_b$, and $\omega_a + 2\omega_b$ are easy to eliminate, this is no longer true with some IM3 terms like $2\omega_a - \omega_b$ and $2\omega_b - \omega_a$ that are in the same frequency range as ω_a and ω_b . If one of these latter terms carries information (modulated), then you must be sure that the other terms will not interfere with the intermodulation terms. As we said earlier, they fall in the same bands as the useful signal bands and thus cause unrecoverable jamming and interferences.

Figure 4 shows that even with strong expensive filters, it will not be easy (even impossible) to remove the IM3 terms because they are embedded in the useful band! This is precisely why in RF the third-order terms are so critical and must be known, measured, and minimized everywhere in the signal chain.

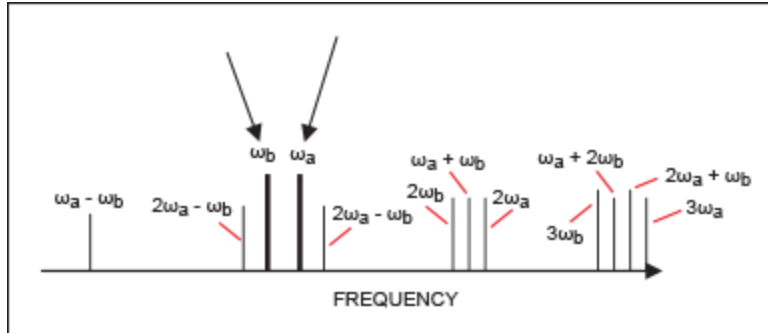

Figure 4. A graphic view of the different frequencies generated by a two-tone input signal applied to a nonlinear device.

- **Fourth-Order Products: $A_4 \cdot x^4$**

A similar pattern also applies to frequencies $4\omega_a$, $4\omega_b$, $2\omega_a + 2\omega_b$, $2\omega_a - 2\omega_b$, $\omega_a + 3\omega_b$, $3\omega_a + \omega_b$, $3\omega_b - \omega_a$, and $3\omega_a - \omega_b$. As with the second-order terms, all the frequencies here are quite removed from the two fundamentals. From these observations, we can easily see that IM products are more dangerous with an odd order of n (i.e., IP3, IP5, IP7, etc.).

- **Nth-Order Products: $A_n \cdot x^n$**

The same process can be applied to the term $(x_a + x_b)^n$. Hopefully, for practical devices the higher-order terms vanish rapidly and can be neglected—this is usually true above IM7 and even sometimes with IM5.

We could continue the discussion by considering x with more than two frequencies, ω_a , ω_b , and ω_c . However, that effort would not add much to our understanding since they will simply give us more IM2, IM3, IM4, etc. frequencies.

Intermodulation (IM) to Intercept Point (IP)

Now that we understand the origins of IM products, and particularly IM3, we are better prepared to determine its values and measure them with a common method and unit of measurement.

Note: IM n are the intermodulation products, while IP n are the actual measures.

The previous discussion showed that the terms for $i > 1$ in the function transfer A are responsible for device nonlinearity. The larger they are, the greater is the distortion. Thus we can simplify and only measure the values of A_2 , A_3 , ... $A_i \dots A_n$.

But such absolute values are meaningless because one does not know how they compare to the useful linear performance (A_1). Therefore, it is more useful to know their deviation versus the good parameter (A_1), or more precisely, the ratio A_i/A_1 or A_1/A_i . We will investigate the latter since it will yield a higher value for a high-linearity device.

We could start by trying to evaluate how the terms compare to A_0 , or A_2 , or any A_i . But those

parameters are not useful. We want a linear behavior (gain, attenuation, etc.), so only A_1 interests the RF engineer.

Since the dynamic of A_1 can be very large, it is convenient to use the dB or dBm units for the ratio. We flag the different contributors in the very original figure of y versus x , but this time the two axes are logarithmic (**Figure 5**).

$$y = A_0 + A_1 \cdot x^1 + A_2 \cdot x^2 + A_3 \cdot x^3 + \dots + A_i \cdot x^i + \dots + A_n \cdot x^n \quad (\text{Eq. 14})$$

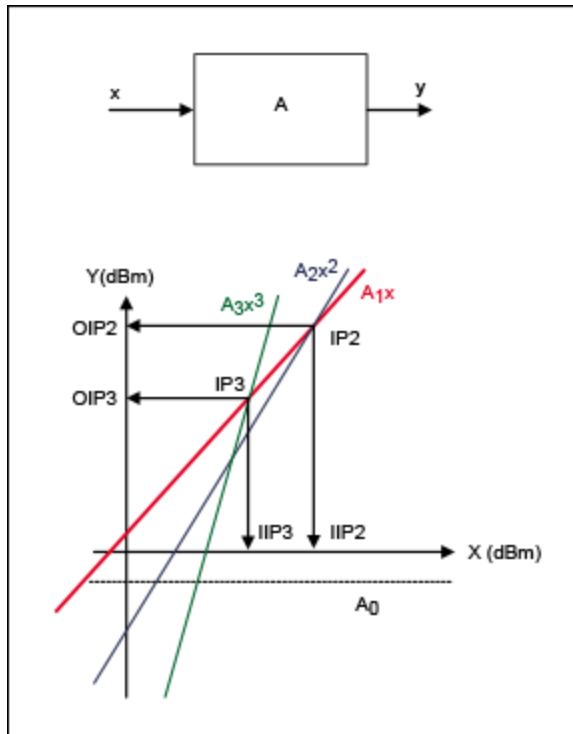

Figure 5. The individual behavior of terms to y in the log axes.

From Figure 5, we find that:

- The term A_0 is a constant value (offset) and independent of the value of x .
- The term $A_1 x$ is the linear portion; in a double-log scales graph, $y-x$ is a straight line with offset defined by A_1 and the slope is just 1dB/dB (doubling x , results in doubling y).
- The term $A_2 x^2$ is the quadratic term (second order). It has an offset determined by A_2 and a slope that is exactly twice of the previous slope (2dB/dB); or restated, doubling the input x will result in quadrupling y .
- The term $A_3 x^3$ is the third-order part. It is a straight line in the graph $y-x$ with offset determined by A_3 . The slope is exactly three times sharper than for the linear term (3dB/dB); or restated, doubling x will result in multiplying x by 8.
- This log is applied to all the following terms and the n th-order line will have a slope of n dB/dB.

Since the higher-order terms have lines with a sharper slope, sooner or later there will be a moment (a point actually) where the high-order line will cross the first-order line. The crossing points are called

intercept points (IP_n).

One can easily observe that the more a device is linear, the more the first-order line is high in the graph (compared to the other lines). Therefore, a higher value is reached for IP points. Graphically, this is easy to see (**Figure 6**). The slope is fixed, so when the device is strongly linear, the *n*th-order terms will be very small. (The *A_n* lines start from deeper values and, hence, will cross the first-order line much later, far away in the axes.)

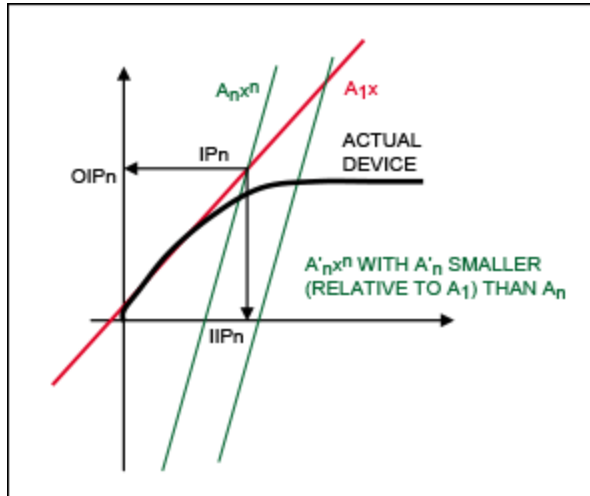

Figure 6. IP_n as crossing points between *n*th-order and first-order curves.

From Figure 6 we see that IP₂ is the point where first-order and second-order lines cross. IP₃ is the point where first-order and third-order lines cross. The process continues in this fashion. The values are read in the *x* or *y* axis. There are thus two actual values for measuring the IP point: the input or output intercept point. They are noted as:

- **IIP_n** for *n*th-order input intercept point, measured on the input power axis (*x*)
- **OIP_n** for *n*th-order output intercept point, measured on the output power axis (*y*)

Relationship Between IIP and OIP

We know that IIP_n and OIP_n are two expressions of the same parameter (IP_n). IP_n is on the first-order line. Thus:

$$\text{Log } Y = \text{Log } (A_1 X) = \text{Log } A_1 + \text{Log } X \quad (\text{Eq. 15})$$

At the intercept point:

$$\text{Log } Y = \text{OIP} \text{ and } \text{Log } X = \text{IIP} \quad (\text{Eq. 16})$$

Therefore:

$$\text{OIP} = \text{Log } A_1 + \text{IIP} \quad (\text{Eq. 17})$$

Log *A₁* is usually the useful gain specified for the device. Therefore, before it gets saturated, we have

simply:

$$OIP_{dBm} = G_{dBm} + IIP_{dBm} \quad (\text{Eq. 18})$$

Intercept Point Evaluation and Measurement

Take care! Those IP_n points are virtual points because they do not really exist. The device saturates well before the signals reach the crossing points. All of these straight lines are, in fact, asymptotes projected from smaller values of x and y . This observation implies that we will need a practical method to extrapolate IP points.

Since we cannot apply and, therefore, measure signals that approach an IP point (because the device would be saturated well before), we need to apply a signal with smaller amplitudes. We can take the x - y figure with the axis in dB (or dBm) (Figure 6) and consider the first-order and the n th-order straight lines:

We apply an input signal, P_{IN} ; it must be small enough to not saturate the device. It will give the corresponding output, P_{OUT} . These points appear in the X and Y axis, respectively (Figure 7):

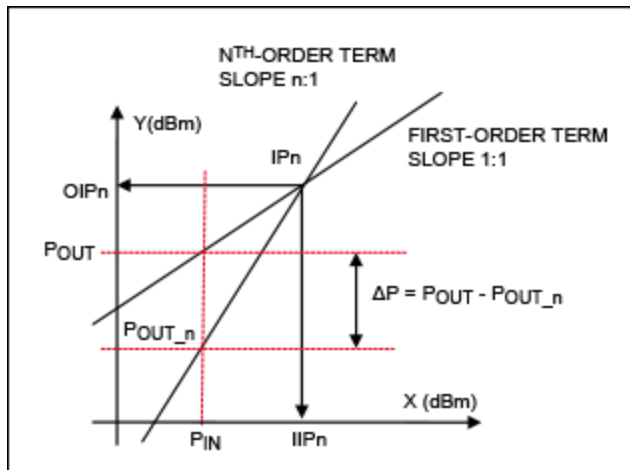

Figure 7. Power levels with straight lines for first-order and n th-order and their intercept points.

In Figure 7, P_{IN} is the applied input signal (from the generator); P_{OUT} is the output signal at the first-order (measured); and P_{OUT_n} is the output at the n th-order (measured). We can call $\Delta P = P_{OUT} - P_{OUT_n}$, which is the difference between measured powers at the first-order and n th-order frequencies.

If the applied signals are pure sinewaves (see the discussion above from equation 1 to equation 8), then the orders can be traced with the frequencies. Using a spectrum analyzer, one can discriminate among the various powers appearing at various frequencies.

We can now determine the relationship between the applied and measured signals versus intercept points (IPs). Figure 8 shows that one can see two triangles inside the rectangle of Figure 7.

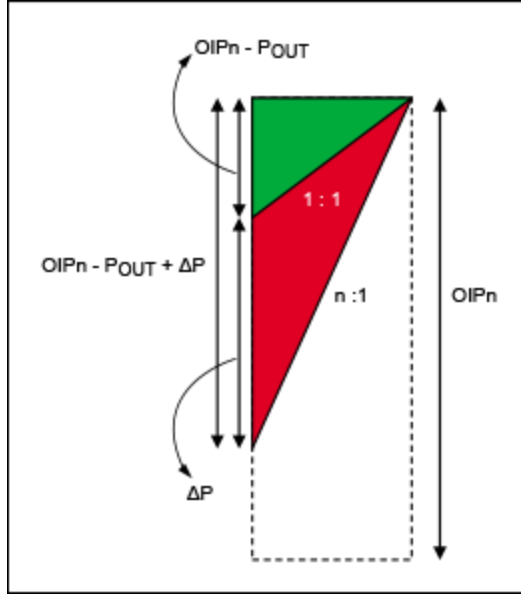

Figure 8. IP_n computation via a graphical method.

Their vertical sides must be in the same ratio as their hypotenuse slopes. Where:

$$n/1 = (OIP_n - P_{OUT} + \Delta P)/(OIP_n - P_{OUT}) \quad (\text{Eq. 19})$$

$$n = 1 + \Delta P/(OIP_n - P_{OUT}) \quad (\text{Eq. 20})$$

$$(OIP_n - P_{OUT})(n - 1) = \Delta P \quad (\text{Eq. 21})$$

$$OIP_n - P_{OUT} = \Delta P/(n - 1) \quad (\text{Eq. 22})$$

Therefore, in conclusion:

$$\mathbf{OIP_n = P_{OUT} + \Delta P/(n - 1)} \quad (\text{Eq. 23})$$

In particular, for IP_3 , we have:

$$\mathbf{OIP_3 = P_{OUT} + \Delta P/2} \quad (\text{Eq. 24})$$

Since $P_{OUT} = P_{IN} + G$, with all terms in dBm, and since $OIP_n = IIP_n + G$, we have:

$$OIP_n = P_{IN} + G + \Delta P/(n - 1) \quad (\text{Eq. 25})$$

$$IIP_n + G = P_{IN} + G + \Delta P/(n - 1) \quad (\text{Eq. 26})$$

Therefore:

$$\mathbf{IIP_n = P_{IN} + \Delta P/(n - 1)} \quad (\text{Eq. 27})$$

Suppose now that we want to measure the IP_3 performance of a given LNA, a device under test (DUT). First, we will need two independent frequency sources: generators GEN-A and GEN-B (**Figure 9**). The two signals will have same amplitudes and with very close frequencies, for example, $\omega_a = 2.00\text{GHz}$ and $\omega_b = 2.01\text{GHz}$ (thus spaced with 10MHz). We can also take 1MHz and 1.001MHz, etc. The frequency

selection depends on the actual device to be tested, i.e., around 433MHz for a European ISM band or 900MHz for the GSM band.

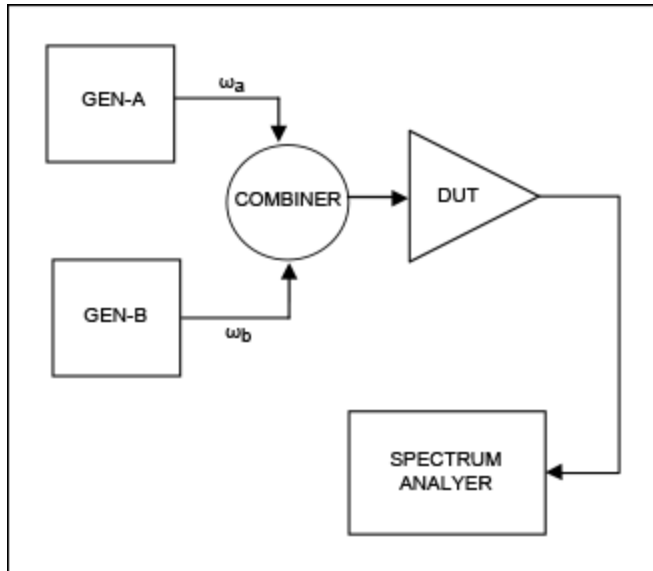

Figure 9. Block diagram for IP3 measurement.

These two frequencies are first applied to a combiner (a sort of "adder") and then injected into the DUT. Some filters can be found between generators and the combiner and from the combiner to the DUT. (Note: make sure that a filter is applied *only* to the two selected sources to the DUT.)

Using a spectrum analyzer, we observe the output. We find, of course, the two original sources at fundamental frequencies and all the harmonics and the intermodulation products (IMs).

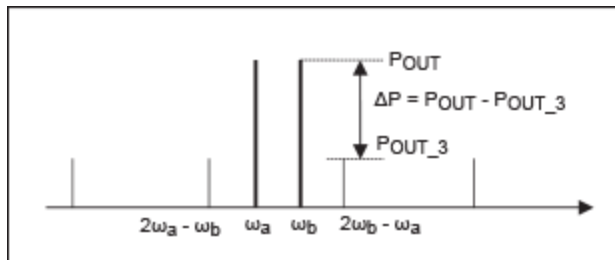

Figure 10. Schematic view of data generated by a spectrum analyzer of IP3 measurements.

In **Figure 10**, P_{OUT} and ΔP are measured directly on the screen; further, $OIP3 = P_{OUT} + \Delta P/2$.

Figure 11 shows a typical view of a spectrum analyzer screen of an IP3 measurement:

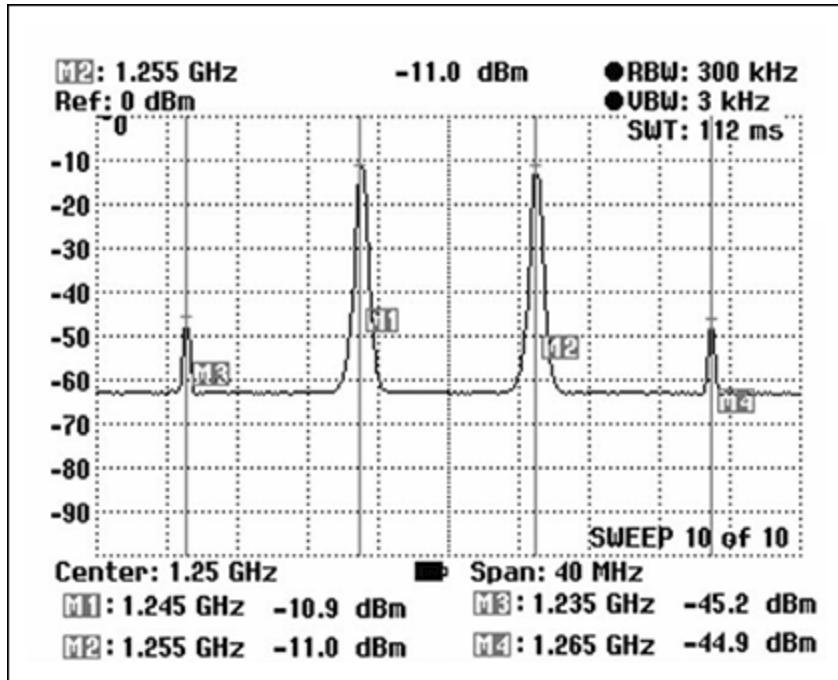

Figure 11. Spectrum analyzer screen view during IP3 test.

In Figure 11, M1 and M2 are the traces of the two fundamentals; both were measured around -11dBm (= P_{OUT}), and M3 and M4 are the IM3 signals; they were both measured both approximately -45dBm. Thus:

$$\Delta P = -11 - (-45) = 34 \text{ dB} \quad (\text{Eq. 28})$$

where, ΔP is the power ratio between M1, (or M2) and M3 (or M4) in dBc

Therefore:

$$\text{OIP3} = -11\text{dBm} + 34/2 \text{ dB} \quad (\text{Eq. 29})$$

or:

$$\text{OIP3} = -11\text{dBm} + 17\text{dB} = +6\text{dBm} \quad (\text{Eq. 30})$$

In this device, the gain is +7dB. Therefore:

$$\text{IIP3} = \text{OIP3} - G = 6 - 7 = -1\text{dBm} \quad (\text{Eq. 31})$$

The results from Equation 31 show that this DUT is a standard, good LNA.

Some functions like the first stage of a receiver RF front-end require higher IP3 devices. This is where the [MAX2062](#) can help.

The MAX2062 dual, 50MHz to 1000MHz high linearity RF/IF variable-gain amplifier (VGA) can be configured for many purposes such as a PA predriver, a diversity IF amplifier (thanks to its dual construction), and any VGA for multipath and transmitter applications. The linearity performance of this device is outstanding with an OIP3 of +41dBm and an OIP2 of +56dBm. Each of the two signal paths contains a high-gain 24dB amplifier and two user-programmable attenuators (one digitally controlled, one

analog controlled), giving an adjustable dynamic gain range up to 64dB in steps of 1dB. Also, since all these blocks have accessible RF input and output, one can easily tune the circuit for best NF, best OIP3, or best combined compromises.

In the MAX2062 data sheet, the OIP3 has been characterized with two RF tones of 0dBm each and separated by 1MHz. The tests were made at seven different frequencies: 50MHz, 100MHz, 200MHz, 350MHz, 450MHz, 750MHz, and 900MHz.

Understanding the Effects of Cascaded IPn

Once the IPn performance of an individual device is known, what happens when we combine them in a chain (**Figure 12**)?



Figure 12. Cascaded RF functional blocks with known IPn.

The total gain of a cascaded structure is:

$$G = G1 \times G2 \times G3 \text{ (in linear)} \quad (\text{Eq. 32})$$

or

$$g = g1 + g2 + g3 \text{ (in dB or dBm)} \quad (\text{Eq. 33})$$

One can just use the equation, applied for three stages:

$$\left(\frac{1}{\text{OIP}_n}\right)_{\text{TOT}} = \left(\frac{1}{\text{OIP}_{n_1}} + \frac{G_2}{\text{OIP}_{n_2}} + \frac{G_2 \times G_3}{\text{OIP}_{n_3}}\right) \quad (\text{Eq. 34})$$

(This formula is given without demonstration.)

The -1dB Compression Point (CP1 or CP1dB)

As mentioned in the introduction, IPn is the only way to characterize a device's linearity. The -1dB compression point (CP) is also a figure of merit for measuring nonlinearity. Graphically (**Figure 13**), it is the point where the actual input-output response curve deviates (i.e., drops) by 1dB from the linear asymptote.

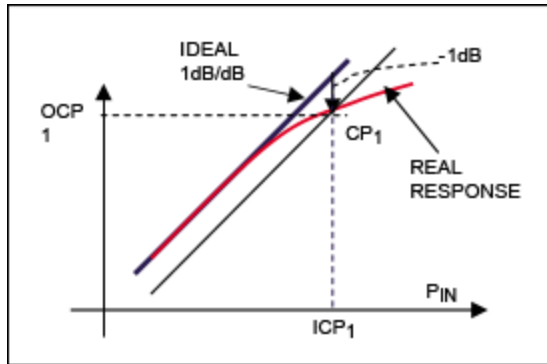

Figure 13. Graphical view of a -1dB compression point.

The -1dB compression point can also be seen as the point where the actual curve crosses the linear dropped by 1dB asymptote. As for the IP parameter, the compression point can be expressed as input (ICP1) or output (OCP1). It can also be observed that CP1 is strongly linked with the IP3 values, even though there is no strict relationship. In general,

$$OCP1 = OIP3 - x \quad (\text{Eq. 35})$$

Where x is usually between -8dB and -12dB.

Consider an example. The versatile [MAX2645](#) is configured as a PA predriver with a gain of 15.2dB. Here the input 1dB compression point (CP1) is -1.8dBm, while its IP3 under the same setup is +11.8dBm. We see that IIP3 and ICP1 differ by 13.6dB.

Conclusion

We hope that the reader now has a clear understanding of how IIPn or OIPn originated and can reconstruct their relationship with input/output powers and gain. Indeed, normally one does not need the above analysis to make an IP3 measurement with a spectrum analyzer. Occasionally, however, engineers require deeper, detailed explanations when faced with an unexpected phenomenon or, perhaps worse, systematically absurd results.

Related Parts		
MAX2027	IF Digitally Controlled Variable-Gain Amplifier	
MAX2055	Digitally Controlled, Variable-Gain, Differential ADC Driver/Amplifier	
MAX2056	800MHz to 1000MHz Variable-Gain Amplifier with Analog Gain Control	Free Samples
MAX2058	700MHz to 1200MHz High-Linearity, SPI-Controlled DVGA with Integrated Loopback Mixer	Free Samples
MAX2059	1700MHz to 2200MHz, High-Linearity, SPI-Controlled DVGA with Integrated Loopback Mixer	Free Samples

MAX2062	Dual 50MHz to 1000MHz High-Linearity, Serial/Parallel-Controlled Analog/Digital VGA	Free Samples
MAX2063	Dual 50MHz to 1000MHz High-Linearity, Serial/Parallel-Controlled Digital VGA	Free Samples
MAX2065	50MHz to 1000MHz High-Linearity, Serial/Parallel-Controlled Analog/Digital VGA	Free Samples
MAX2066	50MHz to 1000MHz High-Linearity, Serial/Parallel-Controlled Digital VGA	Free Samples
MAX2067	50MHz to 1000MHz High-Linearity, Serial/Analog-Controlled VGA	Free Samples

More Information

For Technical Support: <http://www.maximintegrated.com/support>

For Samples: <http://www.maximintegrated.com/samples>

Other Questions and Comments: <http://www.maximintegrated.com/contact>

Application Note 5429: <http://www.maximintegrated.com/an5429>

TUTORIAL 5429, AN5429, AN 5429, APP5429, Appnote5429, Appnote 5429

© 2013 Maxim Integrated Products, Inc.

Additional Legal Notices: <http://www.maximintegrated.com/legal>